

LEGGO ANCH'IO

Seconda parte

Emidio Tribulato
Isabella Ialacqua
Rosaria Visalli

PRA

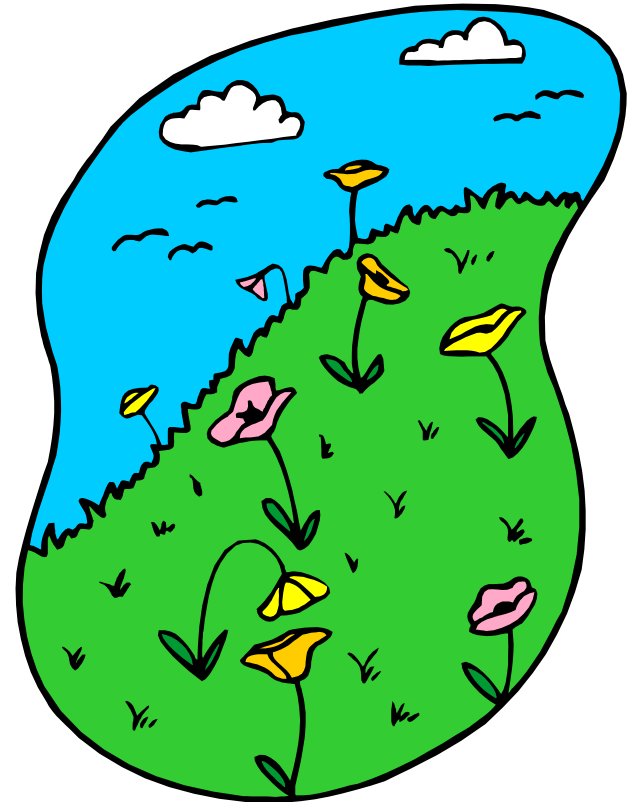

FRU



Volume 4

CENTRO STUDI LOGOS - MESSINA

CENTRO STUDI LOGOS
ONLUS
CENTRO DI RICERCHE PSICOPEDAGOGICHE
VIA PRINCIPE TOMMASO 2 - MESSINA
TEL. 090/46920
DIRETTORE: DOTT. EMIDIO TRIBULATO

“LEGGO ANCH'IO”

LETTURA SILLABICA FACILITATA

Seconda parte

*Emidio Tribulato
Isabella Falaequa
Rosaria visalli*

 2009 - Tutti i diritti riservati.

E - mail: postmaster@cslogos.it --- Sito web: www.cslogos.it

Vol. IV

SBA sba *Sba sba*



SBADIGLIARE
sbadigliare

Sbadigliare
sbadigliare

SBE sbe *Sbe sbe*



SBERLEFFI
sberleffi

Sberleffi
sberleffi

SBI sbi *Sbi sbi*



SBIRCIARE
sbirciare

Sbirciare

SBO sbo *Sbo sbo*



SBORNIA

sbornia

Sbornia

sbornia

SBU sbu *Sbu sbu*

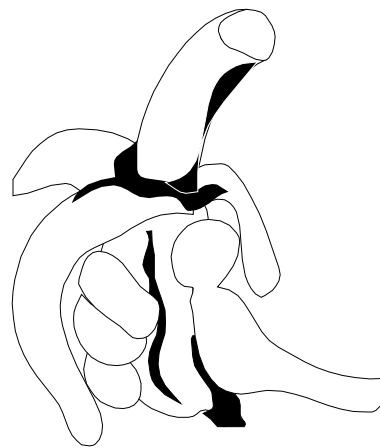

SBUCCIATA

sbucciata

Sbucciata

sbucciata

Cerca le **SBA**

SMA SBA PRA SBA FLA GUA

GNA SBA GRA SBA SVA SPA

BLA PLA SFA SBA TRA SBA

Cerca le **SBE**

SME TRE CHE SBA PRE SCE

SCHE SFE SBE CLE FLE SBE

SBE GHE SBE GRE SBE PLE

Cerca le **SBI**

SBI CHI PRI SBE PLI SBI

BLI GNI SBI SBI GHI FLI

Cerca le **SBO**

FLO SBO PRO SBO SFO BLO

SVO PLO SBO SBI CRO SFO

Cerca le **SBU**

SBU SBO PRU SFU DRU BLU

SBU FLU CRU SMU GNU SBU ⁶

Cerca le

sba

sba

dra

fra

bla

sma

pla

fla

cra

sba

sfa

sba

bra

sba

sva

sba

gua

tra

sba

Cerca le

sbe

sme

tre

sbe

gre

sbe

sba

ste

sbe

ghe

gre

sbe

sme

sbe

che

fle

sve

dre

sbe

Cerca le

sbi

sbi

tri

dri

chi

sbi

bli

smi

schi

pli

gni

sbi

sbe

Cerca le

sbo

sbo

gro

cro

tro

sbo

sba

dro

smo

sbo

gno

sfo

sbe

Cerca le

sbu

smu

tru

pru

sbu

blu

sbe

sfu

plu

sbu

dru

sbu

flu

Cerca le *sba*

sba dra pla bla sbu sma sba gua

pra sba sbi sma tra cra cla sfa

sva spa sba bla gua bra sta sba

Cerca le *sbe*

sba che sbe dre fre ghe sbe sve

sche sbe pre gne fle sfu sbe che

ble gue sba ble sme ple gue sbe

Cerca le *sbi*

tri dri chi sbi sba ghi fli

sbe gni sbi gui svi pli spi

Cerca le *sbo*

sbo blo cro gno sbo bro sbe

flo sbo dro tro sbo glo svo

Cerca le *sbu*

sbu blu plu pru sbu gnu blu

dru sbo gru blu flu sbu cru

Cerca le *Sba*

Sma Gna Sba Fra Cra Sba Dra Bla
Gna Cla Sbi Gla Sba Sma Cra Fla
Fra Sba Pla Bra Sca Sva Sbo Fra

Cerca le *Sbe*

Sme Che Tre Ghe Ble Gre Sbe
Cre Sbe Gre Sba Sche Sme Sbu
Sbe Gne Sve Fle Pre Sbo Gre

Cerca le *Sbi*

Gri Smi Chi Sbi Sba Fri Sbo Gni

Pli Bli Ghi Sbi Gui Bli Sbi Cri

Cerca le *Sbo*

Gro Smo Tro Sbo Fro Sbi Blo Gno

Sbo Dro Gno Sbe Svo Plo Sbo Smo

Cerca le *Sbu*

Smu Sbu Gnu Plu Fru Sbu Sbi

Sbo Cru Plu Svu Sbu Flu Spu

Leggi

sbe

Sbe

Sbe

SBE

sbe

Sbi

sbi

SBI

Sbi

sbi

Sbo

sbo

Sbo

SBO

sbo

SBA

sba

Sba

Sba

sba

Sbu

Sbu

SBU

sbu

sbu



Sbadigliare

Leggi



Un uomo
sbarbato

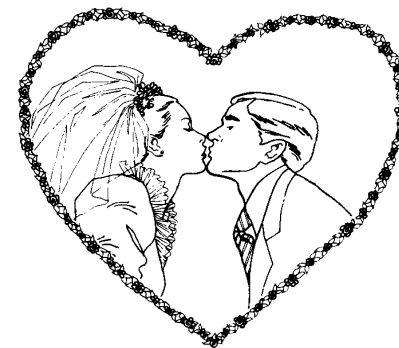

Si sbaciucchiano



Sbarcare



Sbalordito

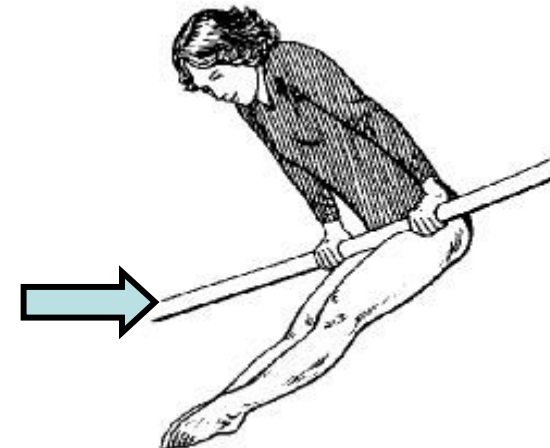

La sbarra

Leggi



E' sbeffeggiata

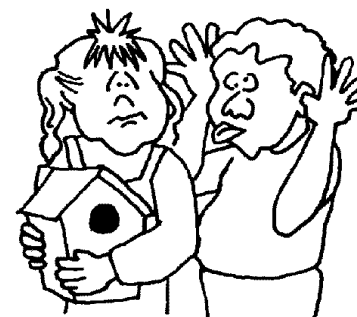

Sberleffi



Sbellicarsi dalle risate

Leggi



Sbirciare



Sbigottito



Un maglione sbiadito



Una cornice sbilenca

Leggi



Sbornia



La giacca
sbottonata

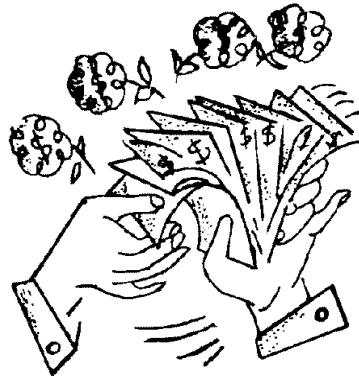

Sborsare



Il disboscamento

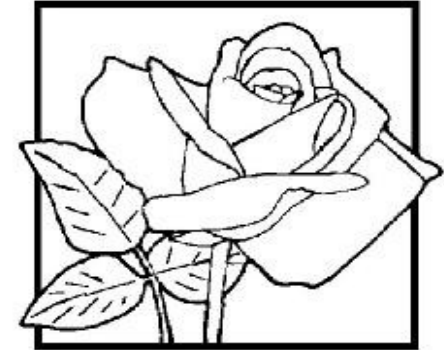

Una rosa sbocciata

Leggi

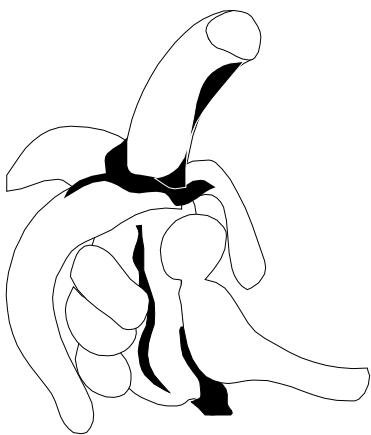

La banana sbucciata



Il braccio e la gamba
sono sbucciate

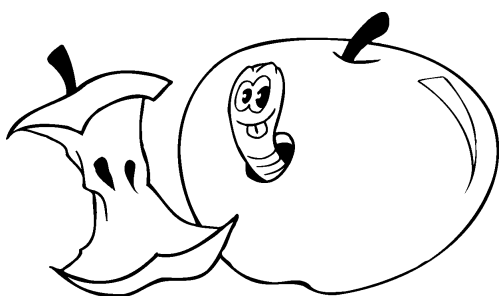

La mela sbucata



Sbuffare

Leggi

Tutti vogliono
sbaciucchiare
e sbalottare
Francesca.



Durante
la
lettura
Claudia
sbadiglia
per la
noia.

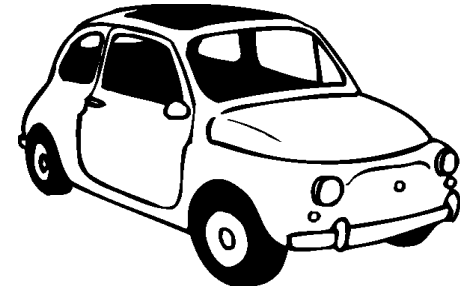

Gli sbadati rischiano
di far sbandare l'auto.

Michele e Flavio
correndo
con le
biciclette
hanno sbattuto
l'uno contro l'altro.

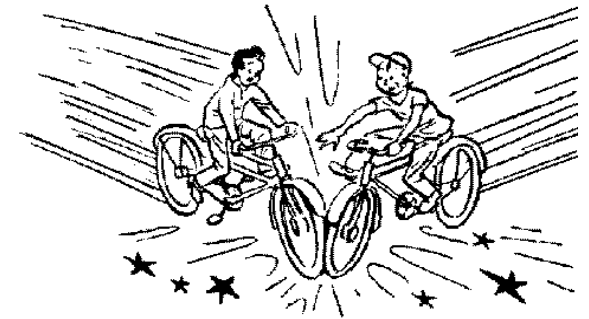

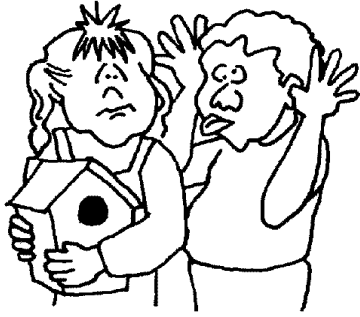

Fare gli sberleffi è il modo migliore per rendersi antipatici.



La brocca si sbecca facilmente se sbatte su una superficie dura.

Leggi



Nell'educazione di un bambino vanno evitate le sberle.



I bambini si sbellicano dalle rise facilmente.



Le foto sbiadiscono
se esposte
alla luce del sole.



Sbirciare dalle fessure
non è una cosa corretta.

Leggi



L'imbianchino sbianca
le pareti bianche
della casa.

Dopo che si
è presa
una sbornia
si tende a
camminare sbilenchi.





Leggi

Il disboscamento
controllato aiuta il
bosco nella sua crescita.



Alla fine di una
sbornia ci si pente
di aver bevuto troppo.

Bisogna
sbottonare
la giacchetta
prima di toglierla.



Le rose che
mi hai
regalato
sono tutte sbocciate.



Leggi

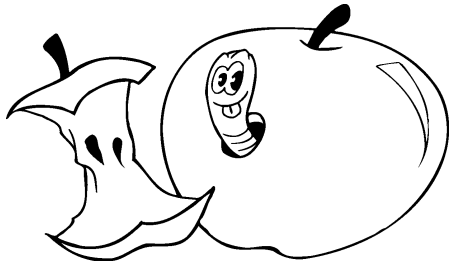

Il verme spesso
sbuca la mela
per uscire.

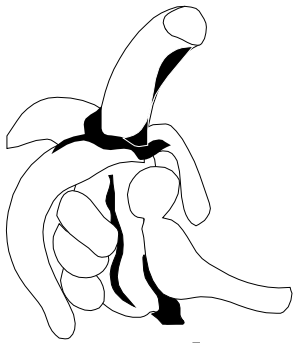

Bisogna sbucciare
la banana
prima di mangiarla.



Il bambino che
corre troppo rischia
brutte sbucciature.

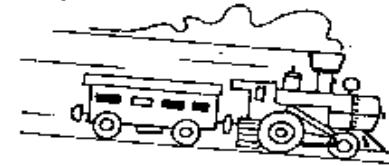

I vecchi treni a vapore
lasciavano lunghi
sbuffi di fumo.

Leggi e associa

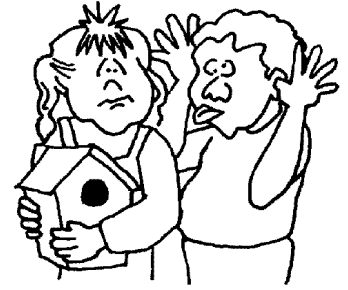
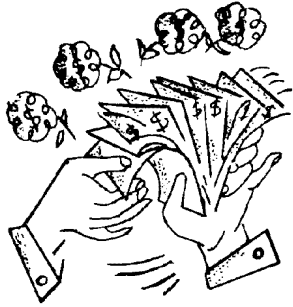

Sberleffi

Un uomo sbarbato

Sborsare

Sbuffare

Una cornice sbilenca

Leggi

Sba sbe

Sbo sbi

SBI SBA

Sbi sbu

Sbi sbe

sbu sbi

Sbu sbo

Sbi sbe

Sbu sbo

Sba sbi

Sbo sbe

Sbe sbi

O sbo

E sba

O sbi

O sbe

I sbo

u sbi

O sbu

u sbi

o sba

a sbe

a sba

i sbe

O sbu

A sbu

i sbo

Leggi

Sba fle

sbo sfa

SBU SFI

smu sbe

sbi sme

sba sfi

sfo sbi

sbu sfe

smu sbo

fla sba

sbu flo

sfo sbi

O flo

E sba

O fli

O smu

I sbo

u sbi

O sfe

u sbe

o sfa

a smo

a sbu

i sfu

O flu

A sma

i sbi

SBA come ...
sba come ...

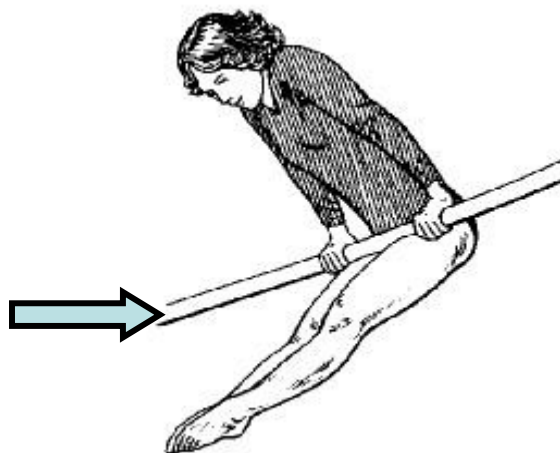

SBE come ...
sbe come ...



SBI come ...

SBO come ...

sbo come ...

SBU come ...

sbu come ...

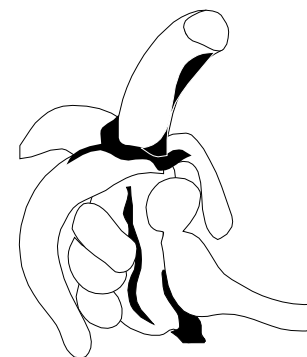
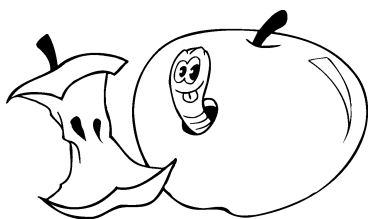
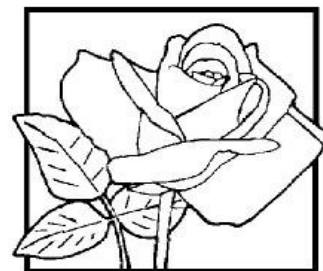

QUA qua *Qua qua*

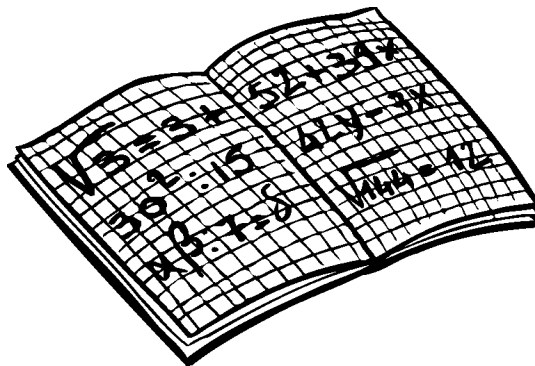

QUADERNO
quaderno

Quaderno
quaderno

QUE que *Que que*

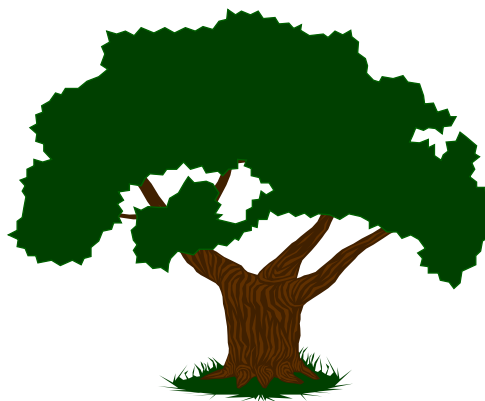

QUERCIA
quercia

Quercia
quercia

QUI qui *Qui qui*

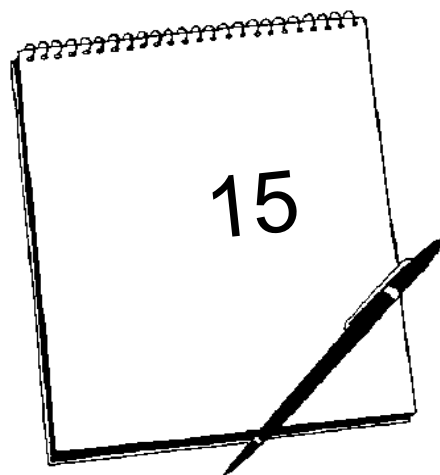

QUINDICI

quindici

Quindici

quindici

QUO quo *Quo quo*

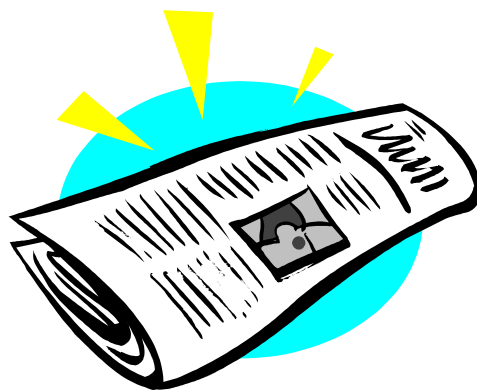

QUOTIDIANO

quotidiano

Quotidiano

quotidiano

Cerca le **QUA**

SMA	QUA	PRA	QUA	FLA	GUA
GNA	QUA	GRA	SBA	QUA	SPA
BLA	QUA	SFA	QUA	TRA	SBA

Cerca le **QUE**

SME	QUE	CHE	QUE	PRE	SCE
SCHE	SFE	QUE	CLE	FLE	SBE
QUE	GHE	QUE	GRE	QUE	QUA

Cerca le **QUI**

SMI	QUI	PRI	QUI	FLI	GUI
GNI	QUE	GRI	SBI	SVI	SPI
QUI	PLI	SFI	QUI	TRI	QUI

Cerca le **QUO**

SMO	TRO	SCO	QUO	QUA	SMO
SPO	SFO	QUO	CLO	FLO	SBO
QUO	DRO	QUI	GRO	QUO	PLO

Cerca le

qua

qua

dra

fra

bla

sma

qui

fla

cra

qua

sfa

qua

bra

sba

sva

qua

gua

tra

quo

Cerca le

que

sme

tre

que

gre

que

qui

ste

sbe

ghe

gre

que

sme

que

che

fle

sve

qua

sbe

Cerca le

qui

qui	dri	fri	bli	smi	qui
fli	cri	qui	sfi	qua	bri
qui	svi	sbi	gui	tri	que

Cerca le

quo

sbo	fro	sbo	gro	quo	qua
flo	svo	quo	bro	slo	quo
sfo	que	pro	sto	dro	quo

Cerca le *qua*

qua dra pla bla qua sma qua gla
pra sba qui sma tra cra que sfa
sva spa qua bla gua bra sta qua

Cerca le *que*

qua che sbe dre fre ghe que sve
sche que pre gne fle sfu que che
ble que qui ble sme que que sbe

Cerca le *qui*

qua svi sci spi qui qui gni sfi

pli cri qui ghi smi fli que schi

qui cli sbi gli dri qui sti sfi

Cerca le *quo*

sbo quo sfo flo blo que dro gno

spo clo gro quo tro sfo sco que

pro sto bro quo smo sfo quo plo

Cerca le *Qua*

Qua Gna Sba Fra Cra Qua Dra Bla
Gna Cla Qui Gla Qua Sma Cra Fla
Fra Qua Pla Bra Sca Sva Que Fra

Cerca le *Que*

Sme Che Tre Ghe Ble Gre Que
Cre Que Gre Qua Sche Sme Qui
Que Gne Sve Fle Pre Que Gre

Cerca le *Qui*

Qui Qui Qua Tri Cri Sbi Dri Bli
Gni Cli Qui Gli Sfi Smi Gui Qui
Chi Que Pli Bri Sci Svi Gni Qui

Cerca le *Quo*

Smo Quo Tro Que Blo Gro Sbo
Cro Quo Gro Sfo Sco Quo Dro
Flo Glo Que Slo Spo Quo Svo

Leggi

Qui

qui

QUI

Qui

qui

Quo

quo

Quo

QUO

quo

QUA

qua

Qua

Qua

qua

que

Que

Que

QUE

que

Leggi

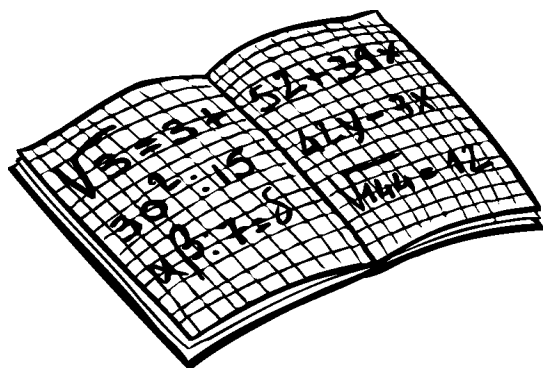

Un quaderno



Un quadrifoglio



Un quadro

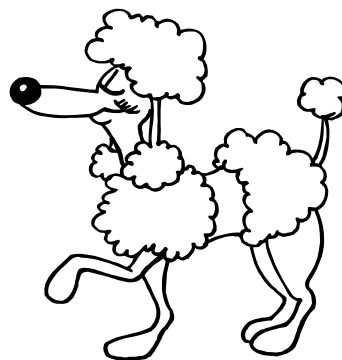

Un animale
quadrupede

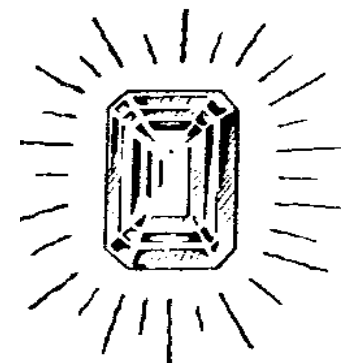

Il quarzo

Leggi



La Questura



Il questore

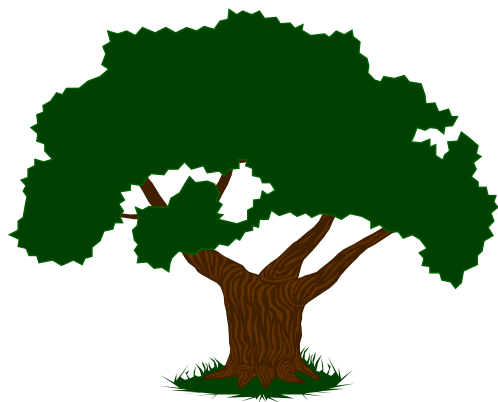

La quercia

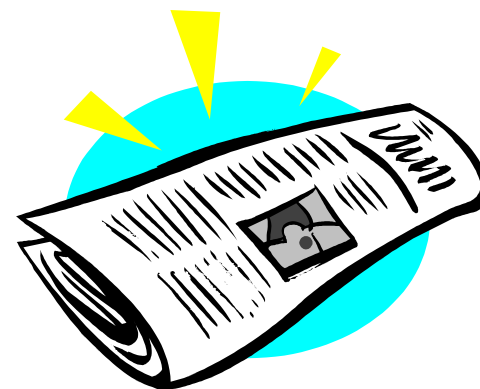

Un quotidiano

Leggi

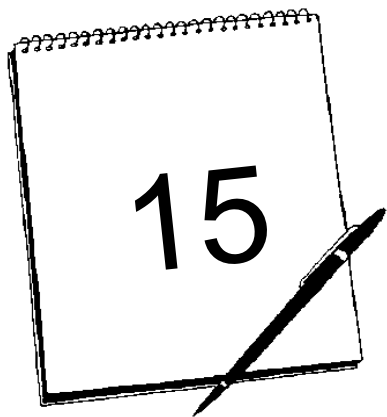

Quindici



Il liquore

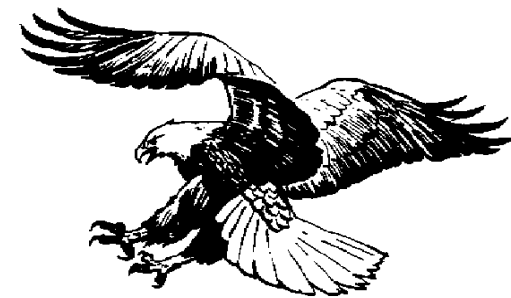

L'aquila



Un aquilone



Un bambino quieto

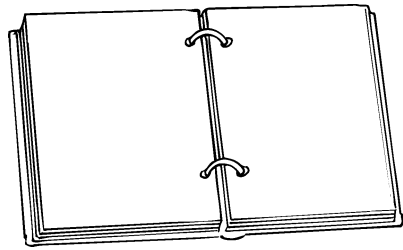

Il quaderno che mi
hai comprato lo userò
per prendere appunti.



Il quadrifoglio è
una pianta composta
da quattro foglie.

Leggi

Il quadrato è
una figura
geometrica
che ha quattro
lati uguali.

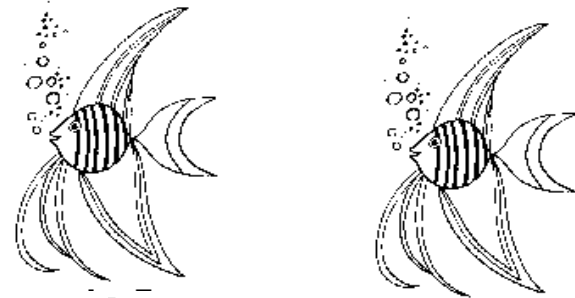

Quando stasera papà
porterà i pesciolini a
casa li metterò
nell'acquario.



Leggi



L'insegnante ha proposto ai suoi alunni di rispondere al questionario di storia.

Ogni questione può essere risolta con il dialogo.

Quel cane ha abbaiato per tutta la notte svegliando tutto il vicinato.

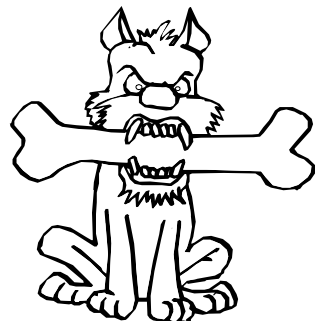

Il papà ha comprato questo orsacchiotto per sua figlia Patrizia.



L'aquilone che vola nel cielo trasporta i sogni di tutti i bambini.



Non essere inquieto per quella questione vedrai che riuscirai a risolverla.

Leggi

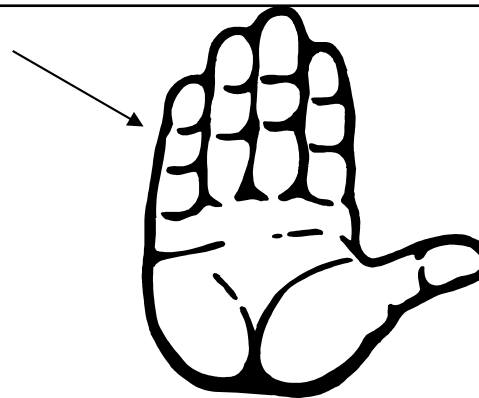

Il quinto dito della mano si chiama mignolo.



“Graziano vieni qui a prendere l'acqua!”



Quando Alessandro
beve troppo
liquore sta male.

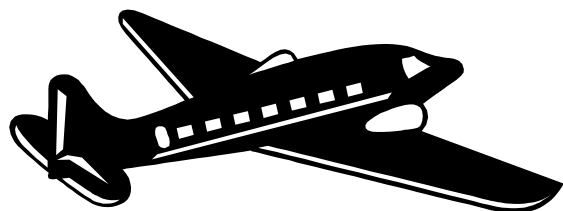

L'aeroplano sta per
prendere quota.

Leggi

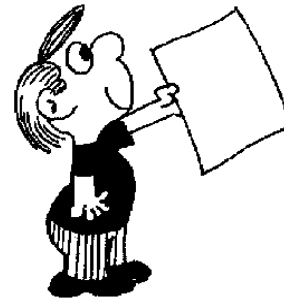

Per migliorare il tuo
quoziente intellettivo
devi studiare molto.

Quando papà ritorna dal
lavoro si siede
in poltrona
e legge il
quotidiano.

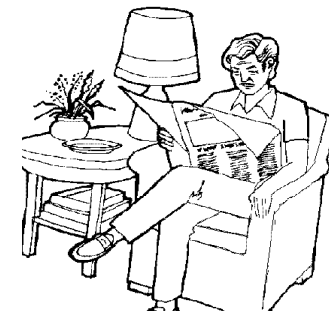

Leggi e associa



Un aquilone

Un quadrato

La questura

Il liquore

Leggi

Qua que

Quo qui

QUI QUA

Qui que

Qui que

qua qui

Quo que

Qui que

Qua quo

Qua qui

Quo que

Que qui

O quo

E qua

O qui

O que

I quo

u qui

O qua

u qui

o qua

a que

a qua

i que

O qui

A quo

i que

Leggi

Qua fle

quo sfa

SBU QUI

flu que

qui sbe

qua sfi

sfo qui

sbu que

sfu quo

qua sba

sbu quo

sfo qui

O flo

E sba

O fli

O qua

I sbo

u qui

O sfe

u sbe

o sfa

a quo

a sbu

i sfu

O flu

A que

i sbi

QUA come ...

qua come ...

QUE come ...

QUO come ...

QUI come ...

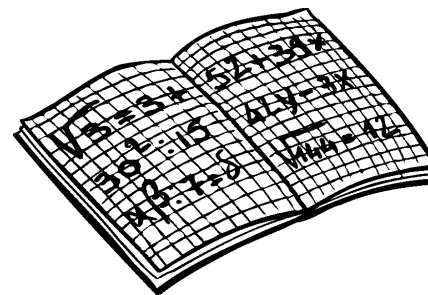
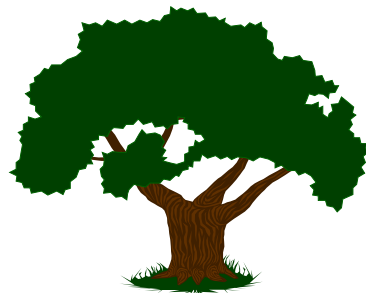
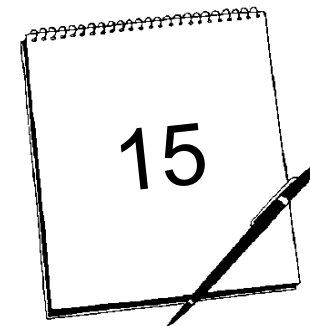

SQUA squa *Squa*

squa

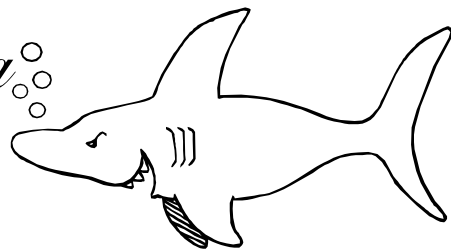

SQUALO

squalo

Squalo

squalo

SQUE sque *Sque*

sque

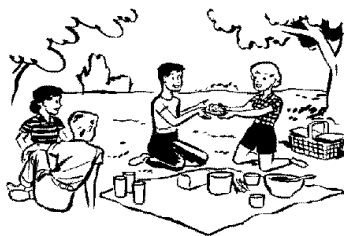

PASQUETTA

pasquetta

Pasquetta

pasquetta

SQUI squi *Squi*

squi



SQUILLARE

squillare

Squillare

Cerca le **SQUA**

SMA SQUA PRA QUA FLA GUA
SQUA QUA GRA SBA SQUA SPA
BLA SQUA SFA SQUA TRA SQUA

Cerca le **SQUE**

SME SQUE CHE QUE PRE SCE
SCHE SFE SQUE CLE SQUE SBE
SQUE GHE SQUE GRE QUE SQUA

Cerca le **SQUI**

SMI SQUI PRI QUI FLI SQUI

GNI SQUI GRI SBI SQUI SPI

BLI SQUA SQUI QUI TRI SQUI

Cerca le

squa

squa

dra

fra

bla

sma

squi

fla

squa

qua

sfa

squa

bra

sba

sva

squa

gua

tra

sque

Cerca le

sque

sme

tre

sque

gre

que

squi

ste

sque

ghe

gre

sque

sme

sque

che

fle

sve

squa

sbe

Cerca le

squi

squi

dra

fra

bla

sma

squi

fla

cra

squa

sfa

sque

bra

sba

squi

qua

gua

tra

squi

Cerca le *squa*

squa dra pla bla squa sma qua gla
pra sba squi sma tra cra sque sfa
sva spa qua squa gua bra sta squa

Cerca le *sque*

squa che sbe dre fre ghe sque sve
sche sque pre gne fle sfu sque che
ble gue squi ble sme que sque sbe

Cerca le *squi*

qui dri pli bli squa smi squi gli
squi sbi qui qui tri cri sque sfi
svi spi squi bli qui bri sti squi

Cerca le

Squa

Sque Gna Sba Fra Cra Squa Dra Bla

Gna Cla Squi Gla Qua Sma Squa Fla

Fra Squa Pla Bra Sca Sva Squa Fra

Cerca le

Sque

Sme Che Tre Ghe Ble Gre Sque

Cre Sque Gre Squa Sche Sme Que

Sque Gne Sve Squi Pre Sque Gre

Cerca le *Squi*

Smi Gni Sbi Squi Cri Squi Dri Bli
Gni Cli Squi Gli Squa Qui Cri Fli
Fri Squi Pli Bri Sci Svi Sque Qui

Leggi

SQUA

squa

Squa

Squa

squa

sque

Sque

Sque

SQUE

sque

Squi

squi

SQUI

Squi

squi

Leggi

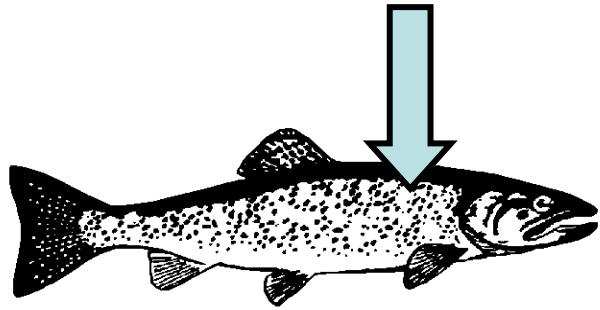

Le squame del pesce

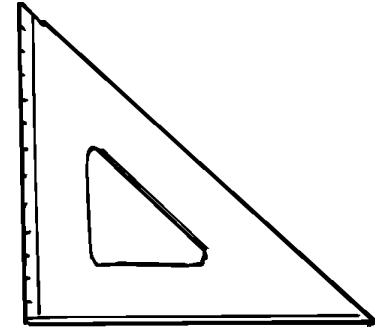

La squadretta



La squadra

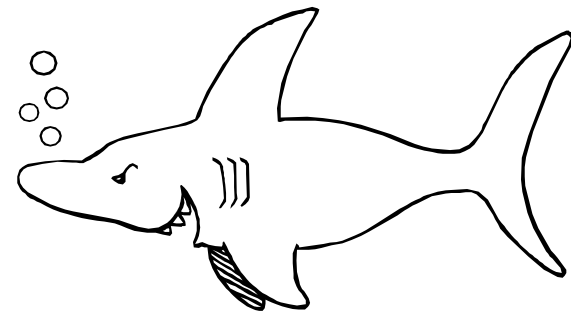

Lo squalo

Leggi

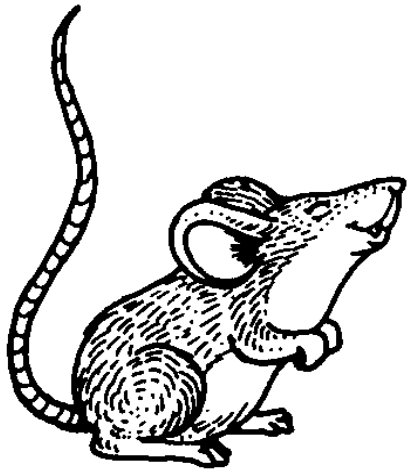

Il topo squittisce

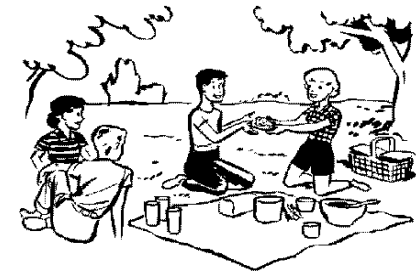

La pasquetta



Ha una voce squillante



Una torta squisita

Leggi

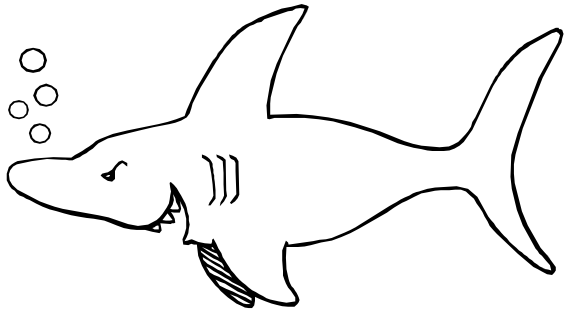

Lo squalo è un pesce ricoperto di squame che squarta le sue prede.

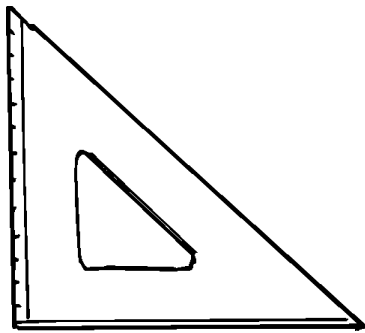

Prima di andare a scuola Pasquale deve mettere nello zainetto la squadretta.

Pietro e Gaspare giocano a calcetto in squadre avversarie.



Quest'anno la mia squadra del cuore vincerà lo scudetto.

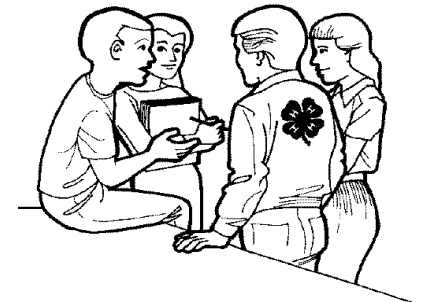

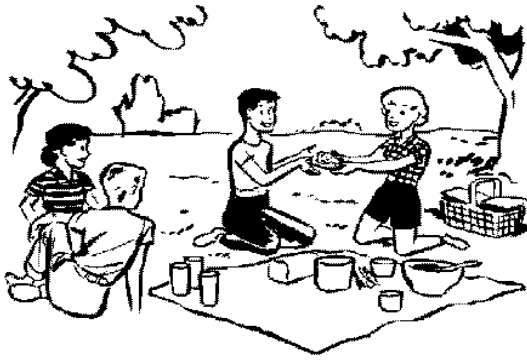

A pasquetta ci si ritrova
sui prati a festeggiare.



Le Pasque che ho trascorso
durante l'infanzia sono state
sempre tranquille.

Leggi



Tra pasqua e pasquetta
troveremo il tempo per
stare insieme ai parenti.

Leggi

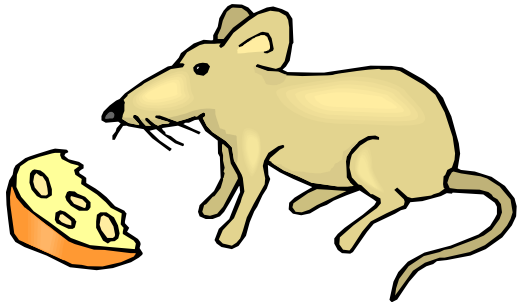

Il topo squittisce di gioia
mentre mangia un
formaggio squisito.

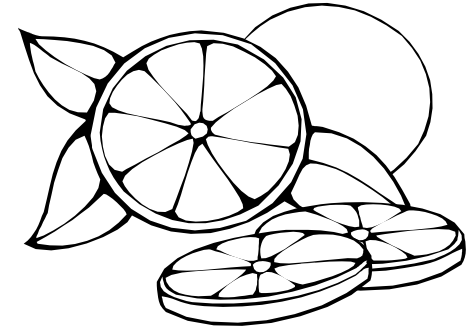

Questa mattina ho
comprato frutta
squisita e fresca.



Il telefono è squillato
molte volte prima che
rispondessi.

Per il mio compleanno
la mamma
ha preparato
una torta
squisita.



Leggi e associa

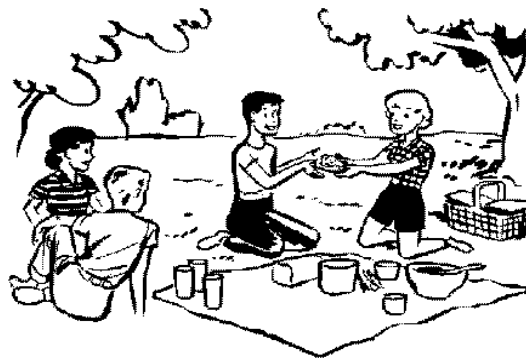
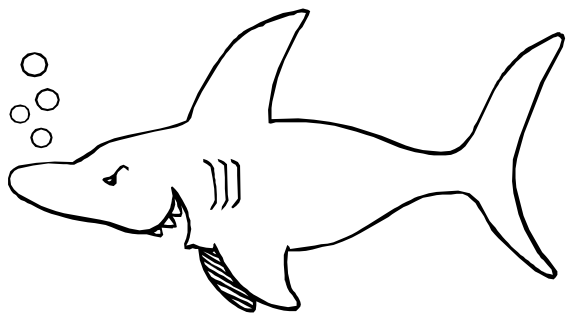

Lo squalo

La pasquetta

Lo squittio del topo

Leggi

Squa sque Sque squi Squi Squa *Squi sque*

Squi sque *squa squi* Squa sque *Squi sque*

Squa squi Squa squi *squi sque* Sque squi

O sque E squa O squi *O sque* I squa

u squi *O squa* u squi o squa a sque

a squa i sque *O squi* A squa i sque

Leggi

Squa fle

quo squi

SFU SQUI

flu sque

squi sfe

squa sfi

sque qui

flu sque

sfu sque

squa qua

sfu squi

sfo squi

O flo

E squa

O fli

O qua

I squi

u qui

O squa

u sque

o sfa

a quo

a sque

i sfu

O flu

A que

i squi

SQUA come ...
squa come ...

SQUI come ...

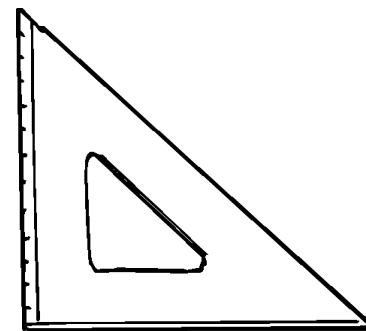
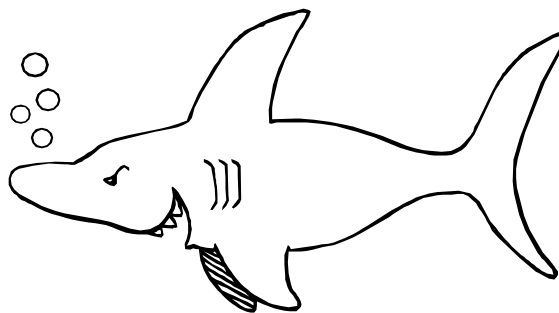

SGHE sghe *Sghe sghe*

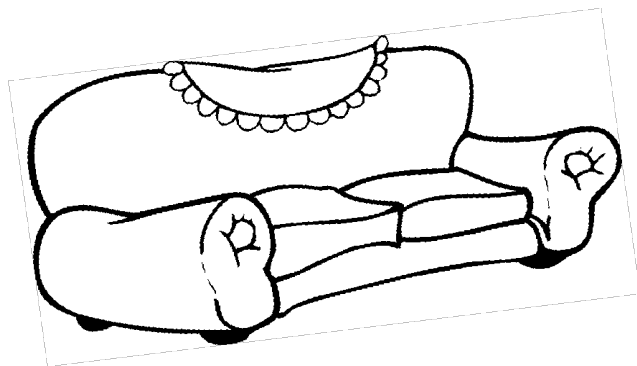

SGHEMBO

sghembo

sghembo

Sghembo

SGHI sghi *Sghi sghi*



SGHIGNAZZARE

sghignazzare

sghignazzare

Sghignazzare

Cerca le **SGHE**

SME	SQUE	PRE	SGHE	FLE	GHE
QUE	SGHE	GRE	SBE	SGHE	SPE
BLE	SGHE	SFE	SGHI	TRE	SGHE

Cerca le **SGHI**

CHI	SGHI	GHI	QUI	SGHI	SCI
SCHI	SFI	SGHE	CLI	SQUI	SBI
SGHI	GHI	SGHI	GRI	QUI	SGHE

Cerca le

sghe

sghe dre sghe ble sme que

fle sghe che sfe sghi bre

sghe sve sque gue tre sghe

Cerca le

sghi

smi sghe squi gri qui sghi

sti sghe ghi gri sghi chi

sghi schi fli svi sghi sbi

Cerca le *sghe*

che sghe ble sme sque sghe que fle
bre sbe sghe ghe fre tre sghi ple
gue sghe sche gle sve gne sfe sghe

Cerca le *sghi*

sghi dri pli bli squi smi qui sghi
pri sbi sghe ghi tri cri sghi sfi
svi spi sghi squi gui bri sti sghe

Cerca le *Sghe*

Sque Gne Sbe Tre Cre Que Dre Ble

Gue Cle Sghe Gle Sghe Sme Sghi Fle

Ghe Sghe Ple Sghi Sce Sve Sche Sghe

Cerca le *Sghi*

Sghi Chi Tri Ghi Bli Sghi Squi

Cri Sghe Gri Sghi Schi Smi Qui

Schi Sghi Ghi Sbi Pri Sghi Dri

Leggi

sghe

Sghe

Sghe

SGHE

sghe

Sghi

sghi

SGHI

Sghi

sghi

Leggi

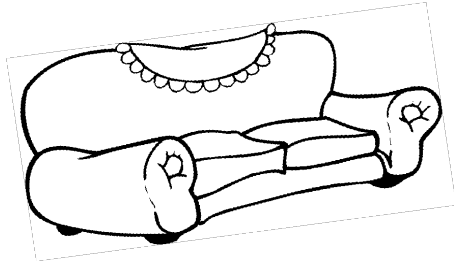

Un divano sghembo



Un uomo sgherro



Il bimbo sghignazza

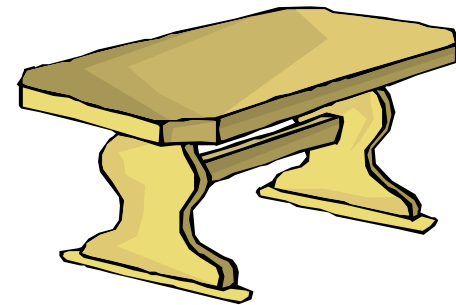

Il tavolo sghimbescio



Patrizia ha la
gonna sghemba.

Il muratore
ha
fatto un
muro
sghembo.

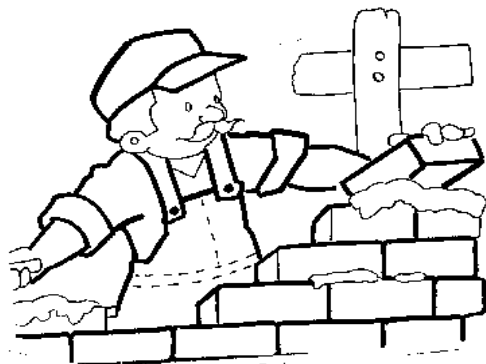

Leggi



Quest'uomo ha
la faccia
di uno sgherro.

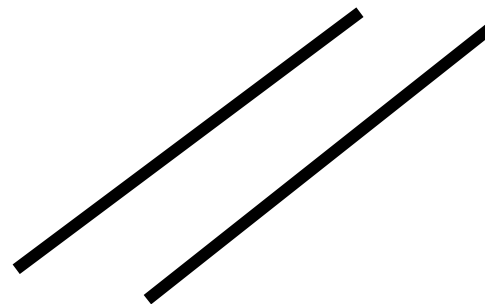

Queste linee sono
troppo sghembe.

Leggi



Pietro mentre fa
il bagnetto
sghignazza sempre.

Quest'uomo
cammina
a sghimbescio.



Questi bambini
quando giocano
sghignazzano
di continuo.

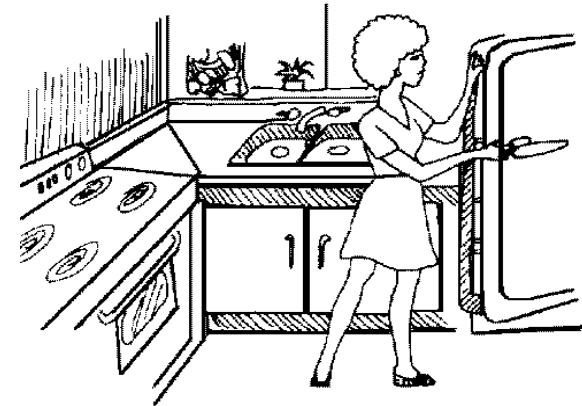

Flavia ha sghiacciato
il frigorifero.

Leggi e associa

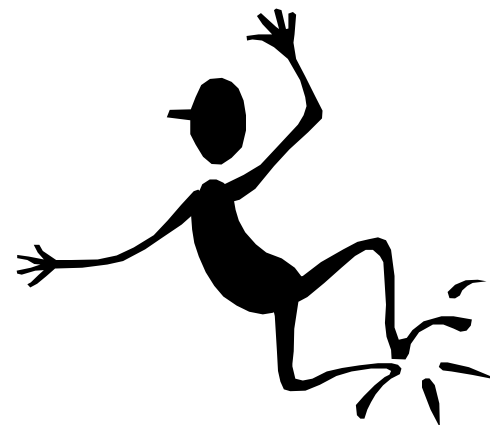
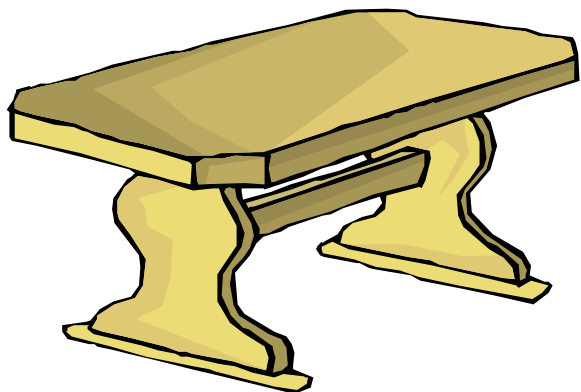

Un uomo sghimbescio

Un tavolo sghembo

Leggi

Sghi sghe Sghe sghi Sghi Sghe *Sghi sghe*

Sghi sghe *sghe sghi* Sghi sghe *Sghi sghe*

Sghe sghi Sghe sghi *sghi sghe* Sghe sghi

O sghe E sghi O sghi *O sghe* I sghe

u sghi *O sghe* u sghi o sghi a sghe

a sghe i sghe *O sghi* A sghe i sghi

Leggi

Sghe sba quo sghi SBU SGHI *squi sghe*
sghi sbe *sghe qui* sghe qui sque sghi
sghe que squa sghi *sbo sghi* quo sghe

O sghe E squa O sghi *O sba* I squi
u qui *O squa* u sque o sghe a quo
a sque i sghi *O sghe* A sbe i squi

SGHE come ...

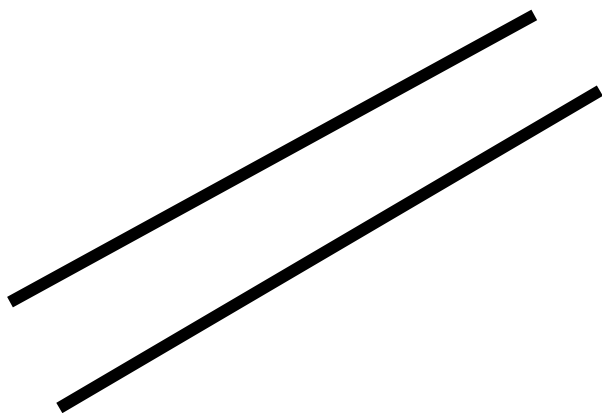

SGHI come ...



STRA stra *Strà strà*

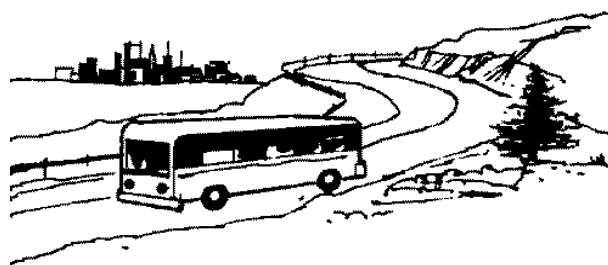

STRADA

strada

Strada

strada

STRE stre *Strè strè*

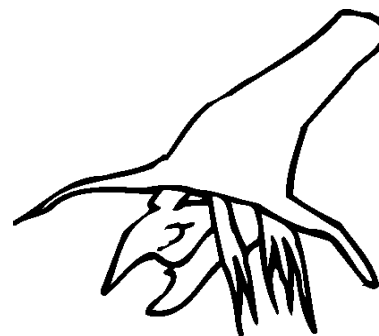

STREGA

strega

Strega

strega

STRI stri *Strì strì*



STRILLARE

strillare

Strillare

STRO stro *Stro stro*

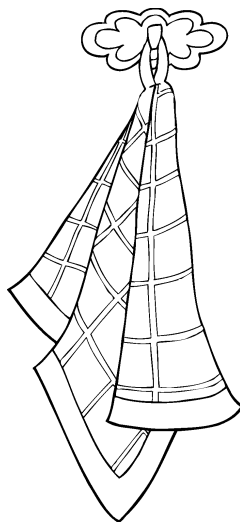

STROFINACCIO
strofinaccio

Strofinaccio
strofinaccio

STRU stru *Stru stru*



STRUZZO
struzzo

Struzzo
struzzo

Cerca le **STRA**

STRA	SBA	QUA	STRA	SFA	GLA
GUA	DRA	SMA	STRA	SQUA	STRA
STRA	FLA	STRE	GNA	CLA	FRA

Cerca le **STRE**

SME	TRE	CHE	STRE	PRE	SCE
SGHE	QUE	STRE	SFE	STRE	FLE
GUE	STRE	STRA	GNE	SBE	STRE

Cerca le **STRI**

QUI STRI SGHI SBI FLI STRI

SQUI GNI STRE STRI GHI STRI

Cerca le **STRO**

STRO SBO PRO QUO PLO STRO

STRO FRO SPO STRI CRO STRO

Cerca le **STRU**

STRU STRO PRU SFU STRU BLU

SMU STRU CRU DRU GNU STRU

Cerca le

stra

stra

dra

fra

bla

sma

stra

qua

squa

stra

sfa

stra

bra

stre

sva

gna

gua

stra

sba

Cerca le

stre

sme

stre

sbe

gre

que

sghe

stre

sbe

ghe

sque

che

stra

stre

cle

fle

stre

stri

pre

Cerca le

stri

sbi stri dri chi stri qui

sghi schi stri squi ghi stri

Cerca le

stro

stro gro cro stro sbo stra

stro smo quo gno stro stri

Cerca le

stru

smu tru stru sbu stru sfu

stru plu stru stro fru flu

Cerca le *stra*

qua dra pla stra stru sma sba gua

pra stra stri squa stra cra da sfa

stra spa stra bla qua bra stra qua

Cerca le *stre*

stra che sbe dre stre ghe sque sve

sche stre pre gne fle sghe ghe stre

stre gue stra que sme stre sque ple

Cerca le

stri

tri dri chi stri stra ghi fli

qui stre sbi gui squi stri spi

Cerca le

stro

quo blo cro gno stro bro stre

stro sbo dro stro quo glo svo

Cerca le

stru

sbu blu plu stru sbu gnu stru

dru stro gru stru flu sfu cru

Cerca le *Stra*

Squa Stra Sba Fra Stra Qua Dra Bla
Gna Cla Stri Gla Pla Sma Stra Fla
Fra Stra Gua Bra Sca Sva Stro Fra

Cerca le *Stre*

Stre Che Tre Ghe Sghe Gre Sbe
Cre Stre Gre Stra Sche Sme Sque
Stre Gne Que Stre Pre Stro Ghe

Cerca le *Stri*

Gri Smi Chi Stri Stra Fri Qui Gni
Pli Sghi Ghi Squi Stri Bli Stri Cri

Cerca le *Stro*

Stro Smo Tro Sbo Fro Stri Blo Gno
Quo Dro Gno Stre Stro Plo Gno Clo

Cerca le *Stru*

Smu Sbu Stru Plu Fru Sbu Stri
Stru Cru Plu Svu Stru Flu Spu

Leggi

Stro

stro

Stro

STRO

stro

Stru

Stru

STRU

stru

stru

STRA

stra

Stra

Stra

stra

stre

Stre

Stre

STRE

stre

Stri

stri

STRI

Stri

stri

Leggi

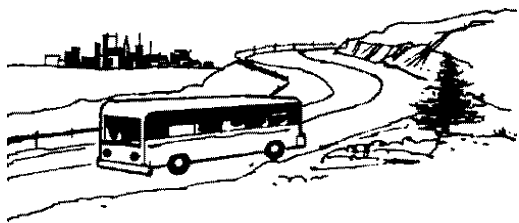

Una strada

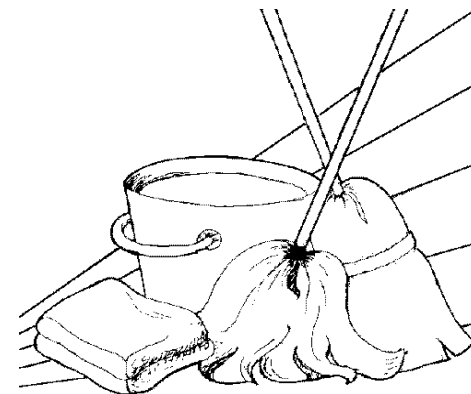

Gli stracci



Lo strascico



Lo straniero

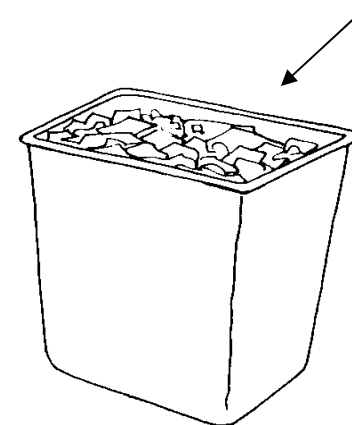

La carta
stracciata



La strega

Leggi

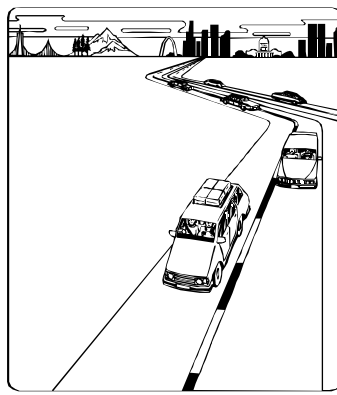

Una strettoia



Lo stregone



Il bambino strepita



La strenna 95

Leggi



Strillare



La biancheria
da strizzare

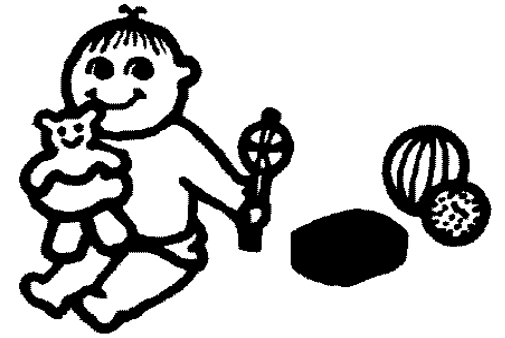

Stringere
l'orsacchiotto



Strisciare

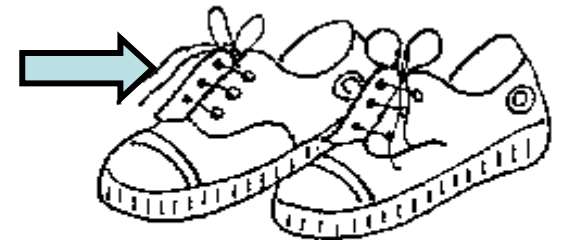

Le stringhe

Leggi

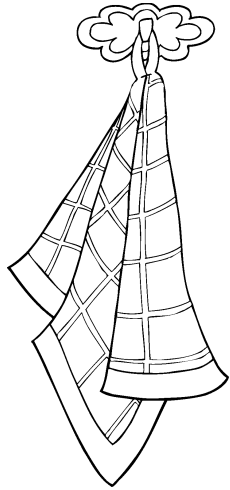

Uno strofinaccio



Strombazzare

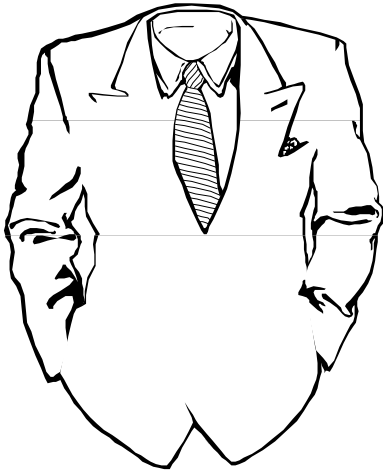

Una giacca stropicciata



La strofa musicale

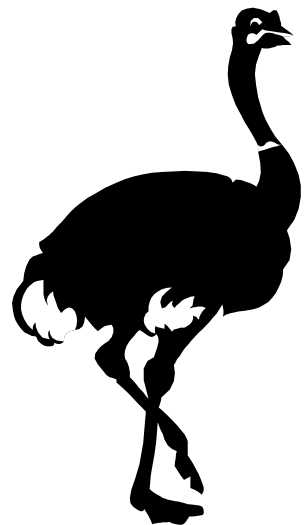

Lo struzzo

Leggi



Istruire

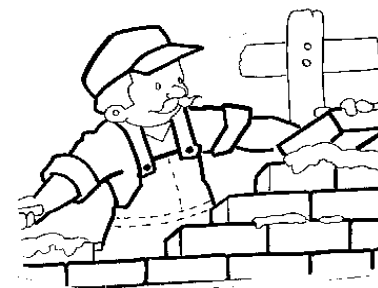

Costruire

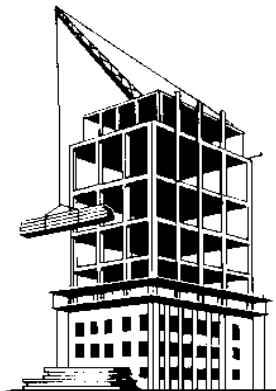

La struttura di un edificio



Uno strumento musicale

Leggi



Gustavo si è procurato
uno strappo muscolare
mentre giocava a calcio.

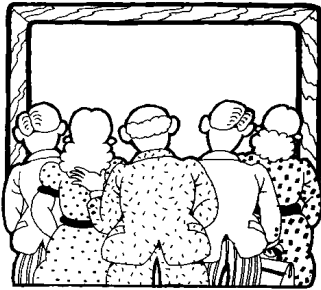

L'anno scorso siamo
stati ad una mostra
di quadri astratti.



Il vestito di Sveva
aveva uno strascico
straordinario.

Per gli italiani
gli indiani sono
una popolazione
straniera.

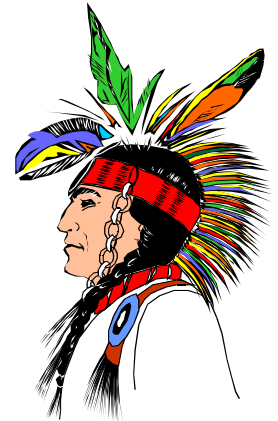



Leggi

Le grandi strenne natalizie fanno guadagnare i venditori.



In passato le streghe che praticavano le magie venivano bruciate sul rogo.

Quest'inverno Cristiano ha scalato la montagna ed è arrivato in cima stremato.

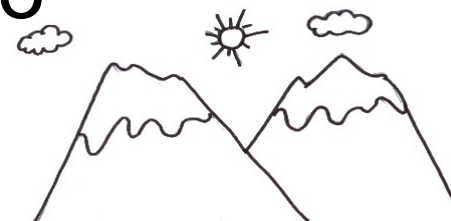

La mamma tiene stretto tra le braccia il suo frugoletto.

Leggi



Grazia ha strizzato i panni bagnati prima di stenderli.



Queste scarpe mi stringono troppo la punta del piede.

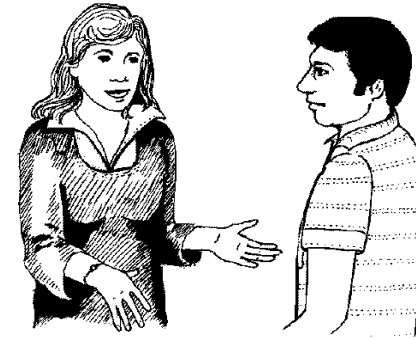

Dovevi sentire gli strilli di Francesco quando gli ho proposto di andare a cena.

La lumaca strisciando ha lasciato una scia per terra.



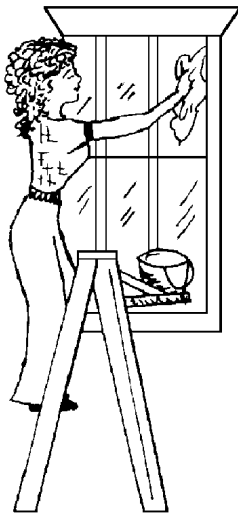

Leggi

Questo strofinaccio
per pulire i vetri
è ormai sciupato.

Il sole è un astro
che ci riscalda
e illumina da
molto lontano.

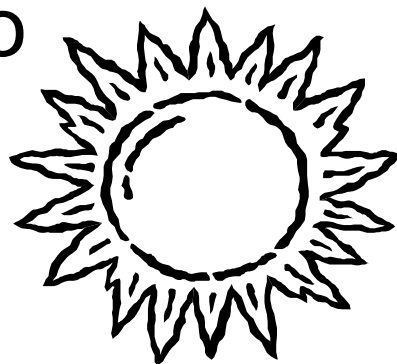

La tromba con cui hai
strombazzato mi ha
fracassato le orecchie.

Lo spartito è
composto
da strofe
musicali.



I palazzi che hanno una struttura in ferro sono praticamente indistruttibili.

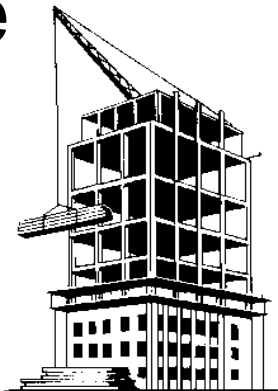

Leggi

Anche lo strumento più semplice ha bisogno di un buon musicista che lo sappia suonare.

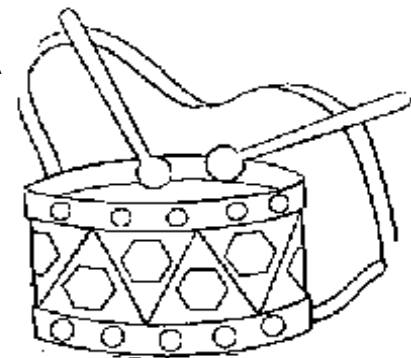

Lo struzzo è un grande uccello africano che può raggiungere una grande altezza.



Chi costruisce bene il proprio futuro si troverà tra i primi.

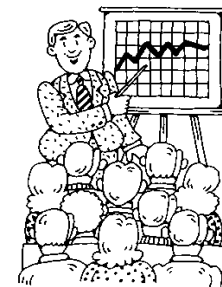

Leggi e associa

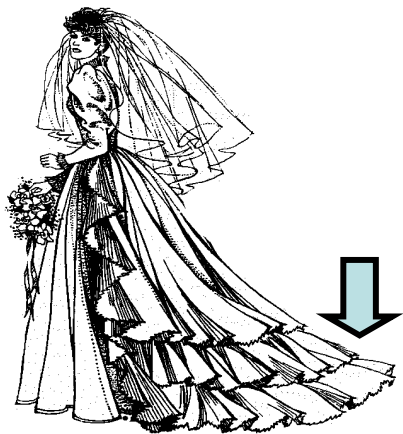

Lo stregone

Lo strascico

Striscia la ...

Uno strumento musicale

Strombazzare

Leggi

Stra stre

Stro stri

STRI STRA

Stri stru

Stri stre

stru stri

Stru stro

Stri stre

Stru stro

Stra stri

Stro stre

Stre stri

O stro

E stra

O stri

O stre

I stro

u stri

O stru

u stri

o stra

a stre

a stra

i stre

O stru

A stru

i stro

Leggi

Stra que stro sghi SQUA STRI *quo stre*
stri sghe *stra squi* stro qui stru sque
quo stro stra squa *que stro* stro sghi

O quo E squa O stri *O sghi* I sque
u qua *O squi* u stra o quo a stro
a squi i stre *O sghe* A stru i sghi

STRA come ...
stra come ...

STRE come ...
stre come ...

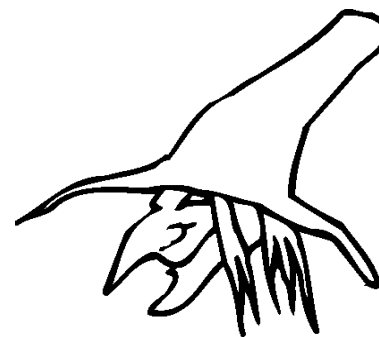
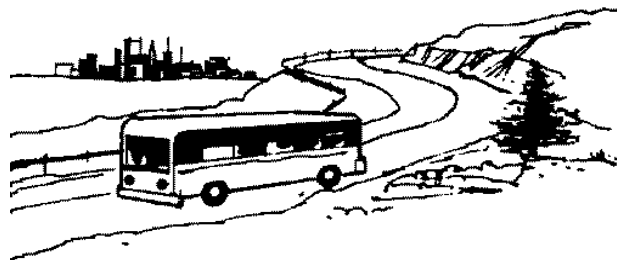

STRI come ...
stri come ...

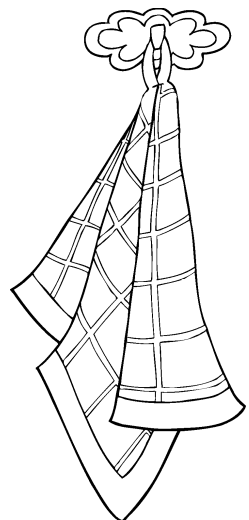

STRU come ...
stru come ...



STRO come ...
stro come ...

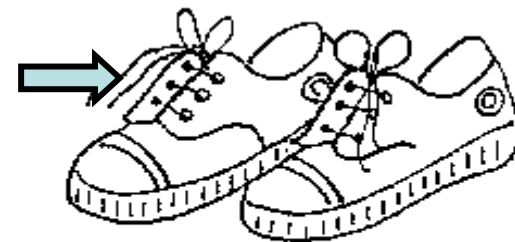

SDRA sdra *Sdra sdra*

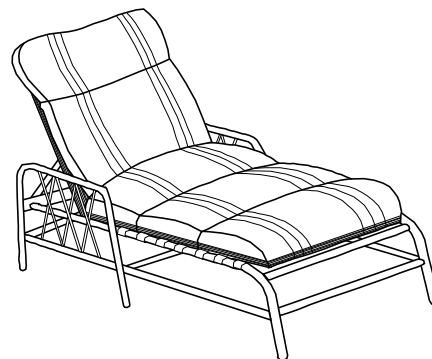

SDRAIO

sdraio

Sdraio

sdraio

SDRE sdre *Sdre sdre*

SDRE

sdre

Sdre

sdre

SDRI sdri *Sdri sdri*

SDRI

sdri

SDRO sdro *Sdro sdro*

SDRO

sdro

Sdro

sdro

SDRU sdru *Sdru sdru*

SDRUCITO

sdrucito

Sdrucito

sdrucito



Cerca le **SDRA**

STRA	SDRA	QUA	SDRA	SFA	GLA
GUA	DRA	SMA	SDRA	SQUA	SDRA
SDRA	FLA	SDRE	GNA	CLA	FRA

Cerca le **SDRE**

SME	SDRE	CHE	STRE	PRE	SCE
SGHE	QUE	SDRE	SFE	SDRE	FLE
GUE	SDRE	SDRA	GNE	SBE	SQUE ¹¹¹

Cerca le **SDRI**

QUI SDRI SGHI SDRI FLI SDRA

SQUI GNI SDRI STRI GHI FLI

Cerca le **SDRO**

SDRO SBO PRO QUO PLO STRO

GNO SDRO SPO SDRI CRO SDRO

Cerca le **SDRU**

SBU SDRU PRU SFU SDRU BLU

SMU SDRU CRU SDRO GNU STRU

Cerca le **sdra**

sdra dra fra bla sdra stra

qua squa sdre sfa sdra bra

sdra sva gna gua sdra sba

Cerca le **sdre**

sme stre sbe sdre que sghe

sdre sbe ghe sque che sdra

sdre cle sdre sche sdri pre

Cerca le **sdri**

sdri stri dri chi sdri qui

sghi sdri stri squi ghi sdre

Cerca le **sdro**

sdro gro cro stro sdro quo

dro sdri squo gno sdro tro

Cerca le **sdru**

smu tru stru sdru sdro sfu

blu plu sdru sbu sdru flu

Cerca le *sdra*

qua sdra pla stra sdra sma sba qua

pra qua sdra squa sdra cra da sfa

sva spa sdre bla qua bra sdra qua

Cerca le *sdre*

stra che sbe dre stre sdre sque sve

sche sdre pre gne sdre sghe ghe stre

sdro gue sdra que sme sdre sque ple

Cerca le *sdri*

sdri dri chi stri sdra ghi fli

qui sdri sbi gui squi sdri spi

Cerca le *sdro*

quo blo cro sdro sdre bro stro

sdro sbo dro sdro quo glo svo

Cerca le *sdru*

sbu blu sdru stru sbu gnu sdru

dru sdre gru smu flu sdru cru

Cerca le *Sdra*

Squa Stra Sdra Fra Sdre Qua Dra Bla
Gna Cla Sdra Gla Pla Sma Sdri Fla
Fra Sdra Gua Bra Sca Sva Sdra Fra

Cerca le *Sdre*

Sdre Che Tre Ghe Sghe Gre Sdre
Cre Stre Gre Sdra Sche Sme Sque
Sdre Gne Que Sdri Pre Sdre Ghe

Cerca le *Sdri*

Gri Sdri Chi Stri Sdra Fri Qui Gni
Sdri Sghi Ghi Squi Stri Bli Sdri Cri

Cerca le *Sdro*

Stro Smo Sdro Sbo Fro Sdri Blo Gno
Quo Dro Gno Sdro Sdro Plo Gno Clo

Cerca le *Sdru*

Smu Sbu Sdru Plu Fru Sbu Sfu
Sdru Cru Plu Sdu Stru Flu Sdro

Leggi

sdre

Sdre

Sdre

SDRE

sdre

Sdri

sdri

SDRI

Sdri

sdri

SDRA

sdra

Sdra

Sdra

sdra

Sdro

sdro

Sdro

SDRO

sdro

Sdru

Sdru

SDRU

sdru

sdru

Leggi



I ragazzi sdraiati

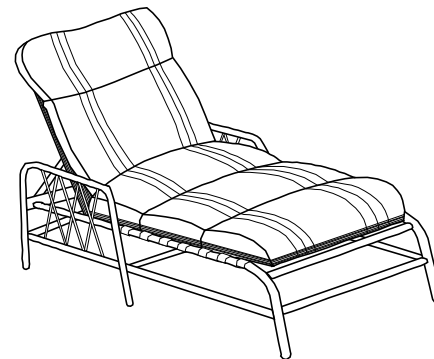

La sedia a sdraio

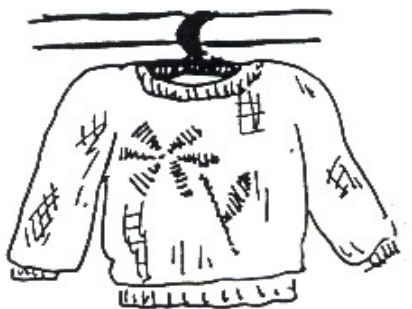

Un maglione sdrucito

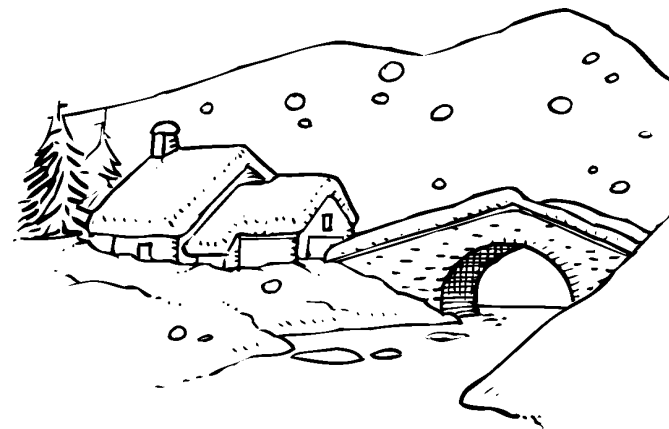

La strada sdruciolevole

Dopo essere
tornato dal
lavoro
Onofrio
si è sdraiato
sull'amaca
che c'è in giardino.

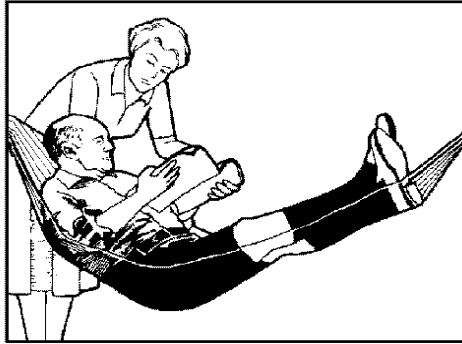

Leggi

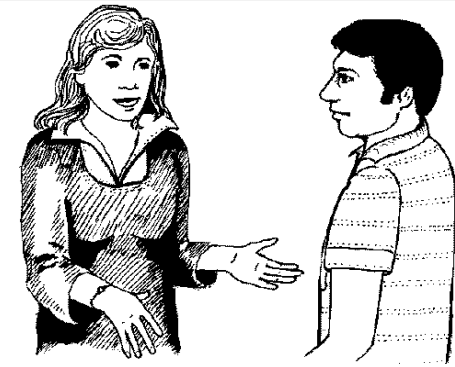

Quando ti capita
qualcosa di triste
cerca di
sdrammatizzare.

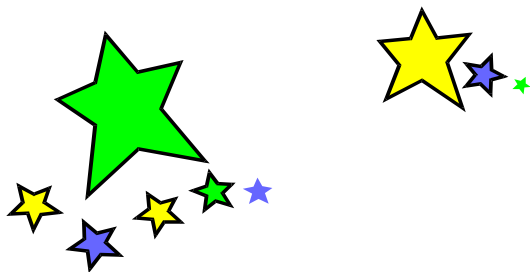

E' bello sdraiarsi sul
prato a guardare le stelle.

Dopo pranzo sdraiati
un po' sul
divano
per
riposarti.

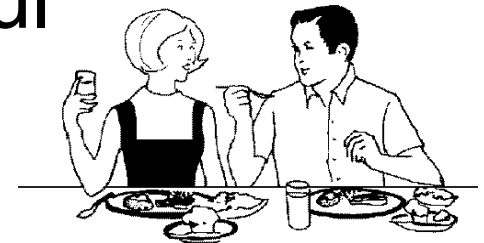



Leggi

Pablo è scivolato sulla
strada sdrucchiolevole
e si è sdrucito il pantalone.

Clarissa si è
appena
accorta di
avere la
gonna
tutta sdrucita.



Francesca ha una
calza sdrucita.

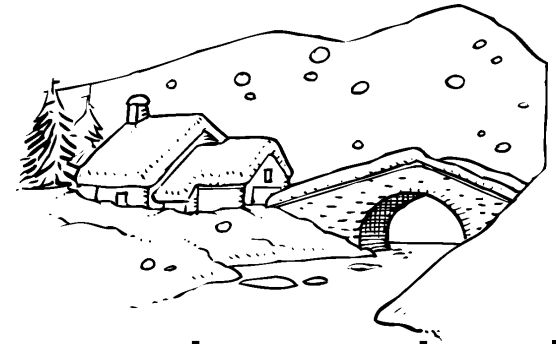

Quando nevica la
strada diventa
sdrucchiolevole
e pericolosa.

Leggi e associa



I ragazzi sdraiati

Un maglione sdrucito

Leggi

Sdra sdre Sdro sdri **SDRI SDRA** *Sdri sdru*

Sdri sdre *sdru sdri* Sdru sdro *Sdri sdre*

Sdru sdro Sdra sdri *Sdro sdre* **Sdre sdri**

O sdro E sdra O sdri *O sdre* I sdro

u sdri *O sdru* u sdri o sdra a sdre

a sdra i sdre *O sdru* A sdru i sdro

Leggi

Stra sdre stro sdri SQUA SDRI *squo sdre*

stri sdre *sdra squi* sdro sghi sdru sque

squo sdro sdra squa *sdre stro* sdro sghi

O sdro E squa O stri *O sghi* I sque

u sdra *O squi* u stra o sdre a stro

a squi i stre *O sghe* A stru i sghi

SDRA come ...
sdra come ...



SDRU come ...

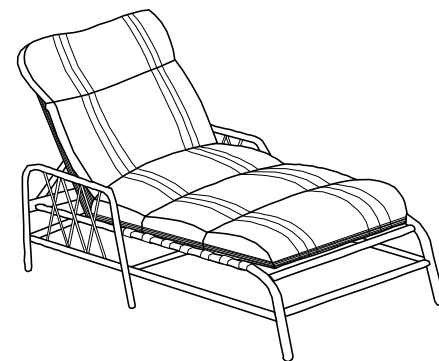

SPRA *spra* *Spra spr*

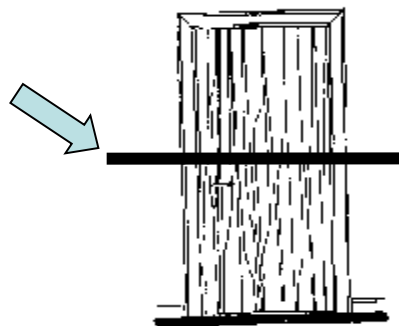

SPRE *spre* *Spre spre*

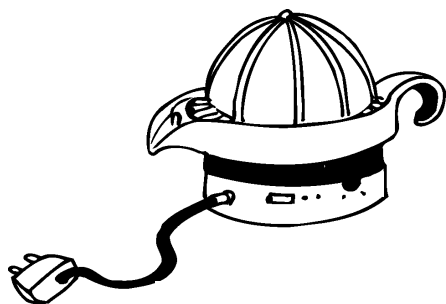

SPRI *spri* *Spri spri*



SPRANGA

spranga

Spranga

spranga

SPREMIAGRUMI

spremiagrumi

Spremiagrumi

spremiagrumi

SPRIZZARE

sprizzare

Sprizzare

SPRO spro *Spro spro*

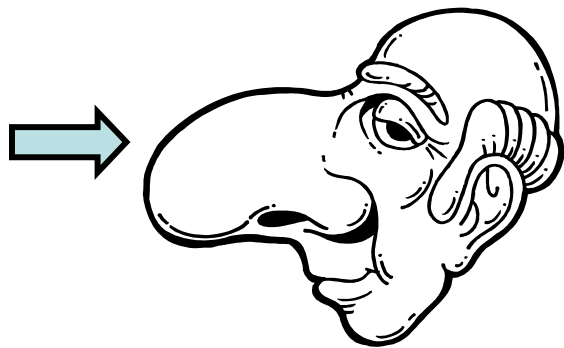

SPROPORZIONATO
sproporzionato

Sproporzionato
sproporzionato

SPRU spru *Spru spru*



SPRUZZATORE
spruzzatore

Spruzzatore
spruzzatore

Cerca le **SPRA**

SPRA SBA QUA SPRA SFA GLA

GUA SPRA SMA SPRA SQUA STRA

SPRA FLA SPRE GNA CLA FRA

Cerca le **SPRE**

SME SPRE CHE SPRE PRE SCE

SGHE QUE SPRE SFE SPRE FLE

GUE STRE SPRA GNE SBE SPRE

Cerca le **SPRI**

QUI SPRI SGHI SBI FLI SPRI

SQUI GNI SPRE STRI GHI SPRI

Cerca le **SPRO**

STRO SBO SPRO QUO PLO SPRO

GNO FRO SPRO STRO CRO SPRO

Cerca le **SPRU**

SBU SPRO SPRU SFU SPRU BLU

SMU STRU CRU DRU GNU SPRU

Cerca le

spra

stra

spra

fra

bla

sma

spra

qua

squa

spra

sfa

spra

bra

spre

sva

gna

gua

spra

sba

Cerca le

spre

sme

spre

sbe

spre

que

sghe

spre

sbe

ghe

sque

che

spra

stre

cle

fle

spre

spri

pre

Cerca le

spri

sbi	spri	dri	stri	spri	qui
sghi	schi	spri	squi	ghi	spre

Cerca le

spro

spro	gro	cro	stro	sbo	spra
dro	smo	quo	gno	spro	spro

Cerca le

spru

smu	spru	stru	sbu	spru	sfu
blu	plu	spru	spro	fru	flu

Cerca le *spra*

qua dra pla spra sprui sma sba qua

pra gna spri squa spra cra cla sfa

sva spa spra bla gua bra spra qua

Cerca le *spre*

spra che sbe dre spre ghe sque sve

sche spre pre gne fle sghe ghe spre

ble gue spraque sme stre spre ple

Cerca le *spri*

stri dri chi spri spragrahi fli

qui spre sbi gui squi spri spi

Cerca le *spro*

quo blo spro gno stro bro spre

spro sbo dro spro quo glo svo

Cerca le *spru*

sbu blu plu spru sbu gnu spru

dru spro gru spru stru sfu cru

Cerca le *Spra*

Squa Spra Sba Spra Stra Qua Dra Bla

Gna Cla Spri Gla Pla Sma Spra Fla

Fra Spra Gua Bra Sca Sva Spro Fra

Cerca le *Spre*

Spre Che Tre Stre Sghe Gre Sbe

Cre Spre Gre Spra Sche Sme Sque

Spre Gne Que Spre Pre Spro Ghe

Cerca le *Spri*

Gri Smi Chi Spri Spri Fri Qui Gni

Pli Sghi Ghi Squi Spri Bli Spri Cri

Cerca le *Spro*

Spro Smo Tro Sbo Fro Spri Blo Gno

Quo Dro Gno Spre Spro Plo Gno Clo

Cerca le *Spru*

Smu Sbu Spru Plu Fru Sbu Spri

Spru Cru Plu Svu Spru Flu Spu

Leggi

spre

Spre

Spre

SPRE

spre

Spri

spri

SPRI

Spri

spri

Spro

spro

Spro

SPRO

spro

SPRA

spra

Spra

Spra

spra

Spru

Spru

SPRU

spru

spru

Leggi

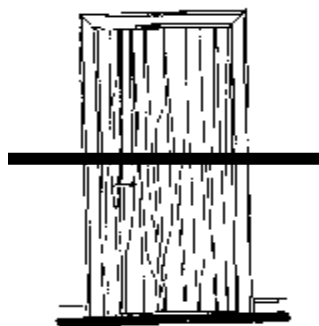

La porta sprangata



Sprazzi di luce



Sprazzi d'acqua



Un uomo spregiudicato

Leggi

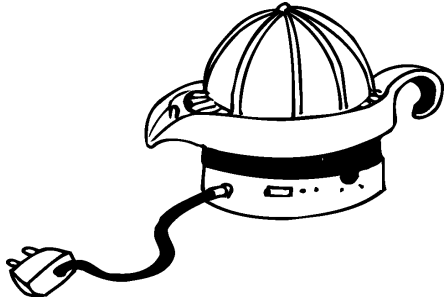

Lo spremiagrumi



Un ladro spregiudicato



Sprimacciare il cuscino

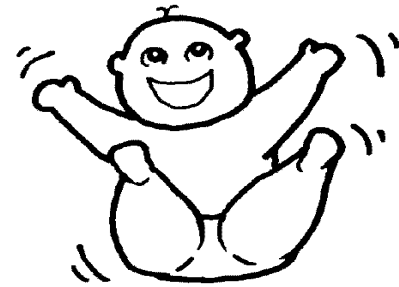

Sprizzare di gioia

Leggi

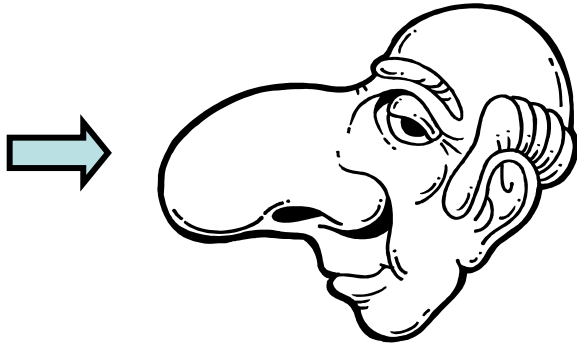

Il naso sproporzionato

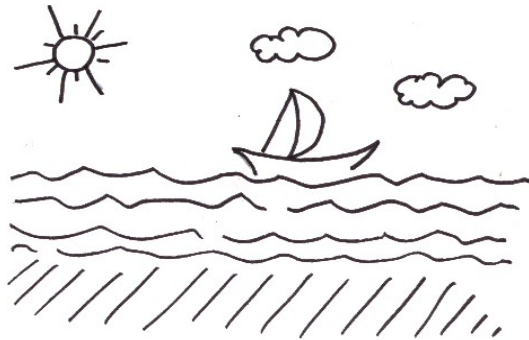

La barca sprofonda



Una donna sprovveduta

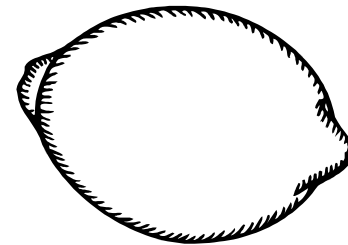

Il limone aspro

Leggi



Lo spruzzatore



Gli spruzzi di neve

Durante l'estate
gli sprazzi di
pioggia
rinfrescano
l'aria.



Le porte dei castelli
Venivano sprangate
all'imbrunire per evitare che
i nemici potessero entrare.

Leggi



Spranga bene la porta
per non fare entrare
i ladri.

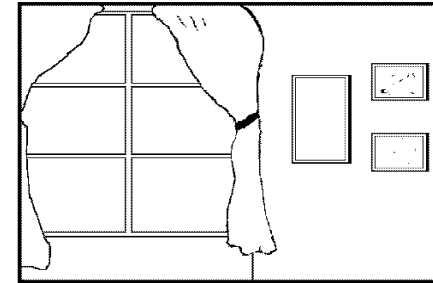

Uno sprazzo di
luce entrava
dalla finestra.

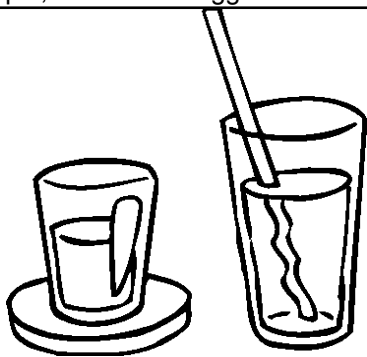

Leggi

Mia madre ha preparato un'ottima spremuta di arancia.

Graziana non sprecare denaro per comprare regali perché ci ho già pensato io.



Il nuovo direttore della banca è un uomo spregiudicato.

Purtroppo Priscilla ha disprezzato il mio vestito nuovo.



Leggi

Durante la notte le rocce sprigionano calore.



Quando nonna Concetta sorride il suo volto sprizza di gioia.

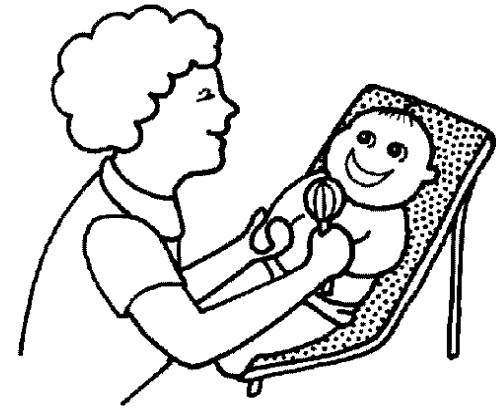

Giancarlo sprizza di gioia mentre la mamma gioca con lui.

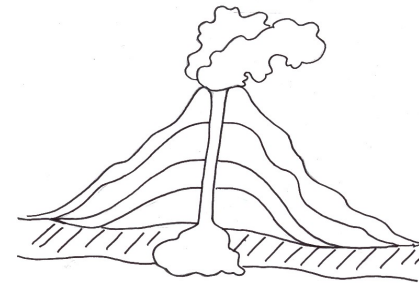

Il vulcano sprigiona fumo e fiamme.

Leggi

Quest'uomo
ha un naso
sproporzionato
rispetto
al resto del viso.

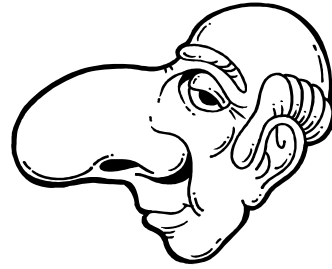

Quell'uomo
era disperato
e sua moglie
temeva che
potesse fare
uno sproposito.

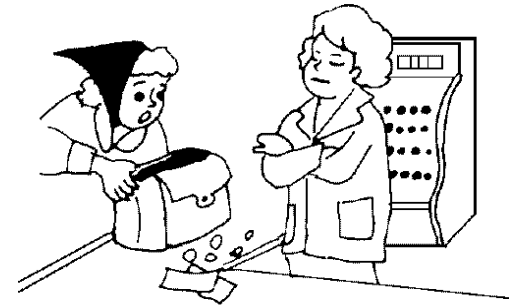

Al momento di pagare
il conto Beatrice si è
resa conto di essere
sprovvista di denaro.

L'interesse e la voglia
di sapere
lo sprona
a studiare.

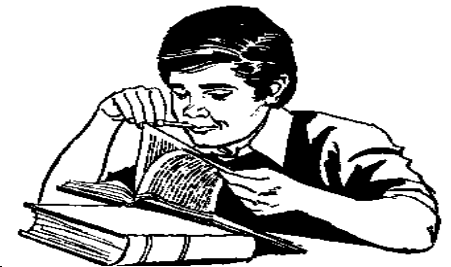

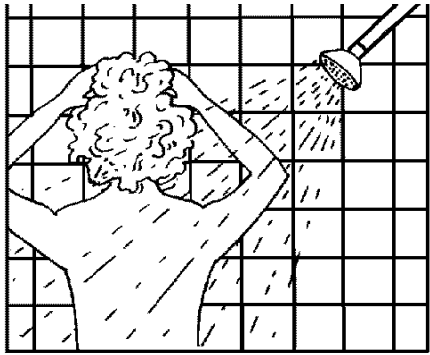

Claudia mentre è
sotto la doccia
ama spruzzarsi
l'acqua addosso.

Mi hai spruzzato
un po' di
inchiostro
sulla faccia.



Leggi

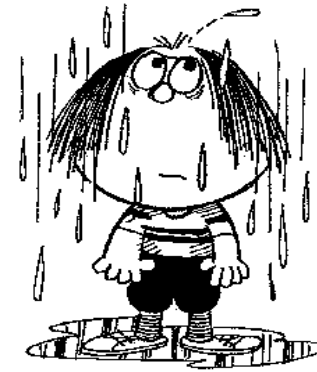

Il temporale improvviso
spruzzò di pioggia
Cristoforo.

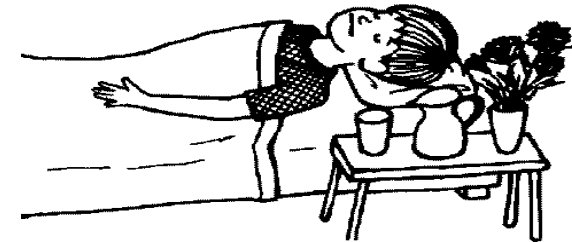

Il dottore le spruzzò
dell'acqua fresca
per farla rinvenire.

Leggi e associa

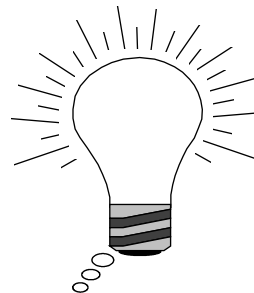
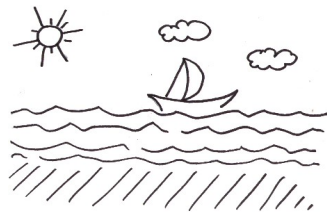

Sprigionare luce

Un uomo spregiudicato

La barca sprofonda

Gli spruzzi di neve

Leggi

Spra spre

Spro spri

SPRI SPRA

Spri spru

Spri spre

spru spri

Spru spro

Spri spre

Spru spro

Spra spri

Spro spre

Spre spri

O spro

E spru

O spri

O spre

I spro

u spri

O spru

u spri

o spru

a spre

a spru

i spre

O spru

A spru

i spro

Leggi

Spra sdre stro spri **SGHE SPRI** *spro stre*

stri spre *spra sdri* stro spri spru sghi

spro stro sprasdra *spre stro* sdro spri

O spro E sprasdra O stri *O sghi* I sdre

u sprasdra *O spri* u sdra o spru a stro

a spre i stre *O sghe* A sdru i sghi

SPRA come ...

spra come ...

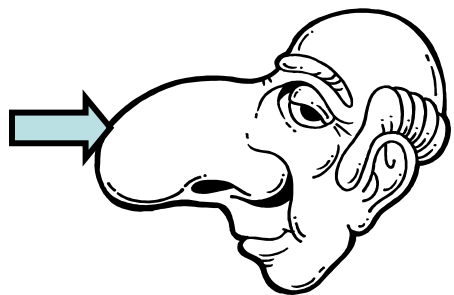

SPRE come ...

SPRO come ...

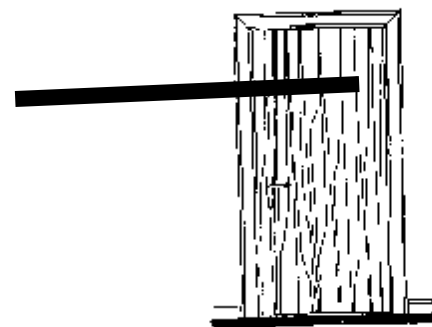
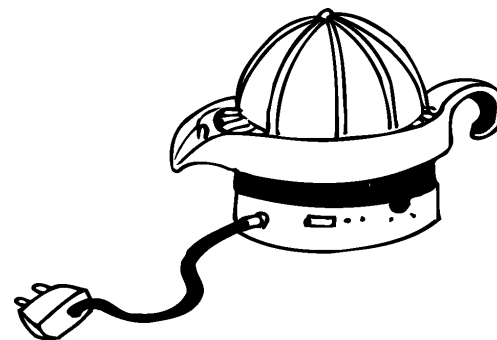

SPRI come ...

spri come ...



SPRU come ...

spru come ...

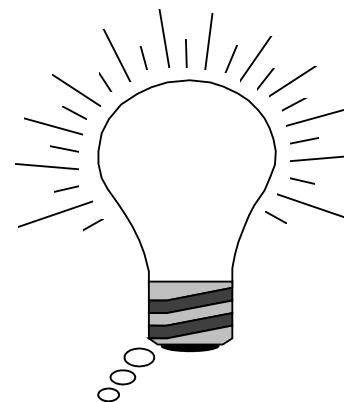

SGRA sgra *Sgra sgra*

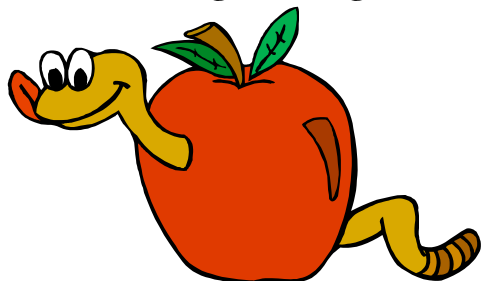

SGRE sgre *Sgre sgre*



SGRI sgrì *Sgrì sgrì*



SGRADEVOLE

sgradevole

Sgradevole

sgradevole

SGRETOLARE

sgretolare

Sgretolare

sgretolare

SGRIDARE

sgridare

Sgridare

SGRO sgro *Sgro sgro*

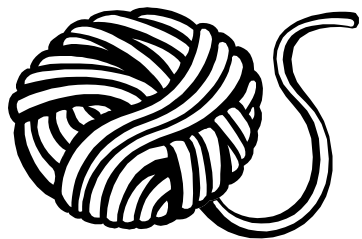

SGROVIGLIARE

sgrovigliare

Sgrovigliare

sgrovigliare

SGRU sgru *Sgru sgru*

SGRU

sgru

Sgru

sgru

Cerca le **SGRA**

SGRA	SBA	QUA	SGRA	SFA	GLA
GUA	DRA	SMA	STRA	SQUA	SGRA
SGRA	FLA	SGRE	GNA	SGRA	FRA

Cerca le **SGRE**

SGRE	TRE	CHE	SGRE	PRE	SCE
SGHE	QUE	SGRE	SFE	SGRE	FLE
GUE	SGRE	STRE	GNE	SBE	SGRA

Cerca le **SGRI**

QUI STRI SGHI SGRI FLI SGRI

SQUI SGRI SGRE SDRI GHI FLI

Cerca le **SGRO**

SGRO SBO PRO QUO PLO SGRO

SGRO FRO SPO SGRI CRO STRO

Cerca le **SGRU**

SBU SGRO PRU SFU STRU SGRU

SMU SGRU CRU DRU SGRU STRU

Cerca le

sgra

sgra	dra	fra	bla	sgra	stra
qua	squa	sgra	sfa	sdra	bra
sgre	sva	gna	sgra	stra	sgra

Cerca le

sgre

sgre	stre	sbe	gre	que	sghe
sgri	sdre	ghe	sgre	che	sgra
stre	cle	fle	sgre	sgri	pre

Cerca le

sgri

sbi stri sdri sgri sgru qui

sghi schi sgri squi ghi sgre

Cerca le

sgro

stro sgro cro tro sgro sgra

dro smo quo gno sgro stri

Cerca le

sgru

smu tru sgru sbu sgru sfu

sgru plu stru sgro fru flu

Cerca le *sgra*

qua sdra pla sgra sgru sma sba qua

pra gna sgrì squa sgra cra cla sgra

sva spa sgra bla gua bra stra qua

Cerca le *sgre*

sgra che sbe sdre sgre ghe sque sve

sche sgre pre gne fle sghe sgre stre

ble gue sgrì que sme sgre sque ple

Cerca le *sgri*

tri sgrì chi sgrì sgra ghi fli

qui sgre sbi qui squi stri spi

Cerca le *sgro*

quo blo sgro gno stro bro sgre

sgro sbo dro stro quo sgro svo

Cerca le *sgru*

sgru blu plu sgru sbu gnu stru

dru sgro grù sgru flu sfu cru

Cerca le *Sgra*

Squa Sgra Sba Fra Sgra Qua Dra Sgra
Gna Cla Sgri Gla Pla Sma Stra Fla
Fra Sgra Gua Bra Sca Sva Sgro Fra

Cerca le *Sgre*

Stre Che Sgre Ghe Sghe Gre Sbe
Cre Sgre Gre Sgra Sche Sme Sque
Sgre Gne Que Sgre Pre Sgro Ghe

Cerca le *Sgri*

Gri Smi Chi Sgri Sgra Fri Qui Sdri
Pli Sghi Ghi Sgri Stri Bli Sgri Cri

Cerca le *Sgro*

Sgro Smo Tro Sbo Fro Sgri Blo Gno
Quo Dro Gno Sgre Sgro Plo Gno Clo

Cerca le *Sgru*

Smu Sgru Stru Plu Fru Sgro Sdru
Sgru Cru Plu Svu Sgru Flu Spu

Leggi

Sgro

sgro

Sgro

SGRO

sgro

Sgru

Sgru

SGRU

sgru

sgru

SGRA

sgra

Sgra

Sgra

sgra

sgre

Sgre

Sgre

SGRE

sgre

Sgri

sgri

SGRI

Sgri

sgri

Leggi

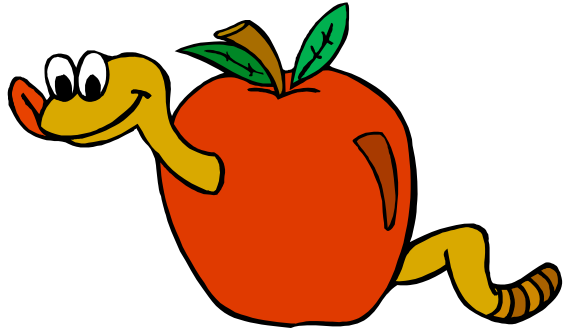

Sgradevole



Sgranchirsi



Sgraffignare



Sgranocchiare

Leggi



Sgridare



Sgretolare



Sgrossare

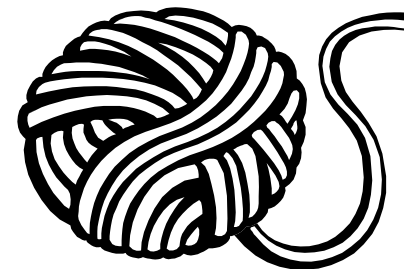

Sgrovigliare

Leggi

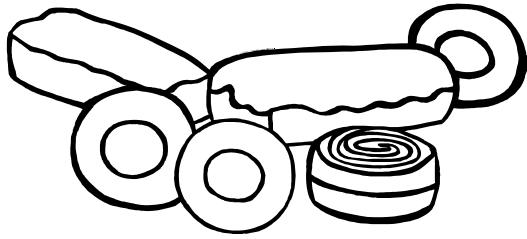

Durante le feste
si sgranocchiano
molti dolci.



Francesca per
sgranchirsi ama fare
molta ginnastica.



Il ladro è stato visto
mentre sgraffignava
dei soldi in un
supermercato.

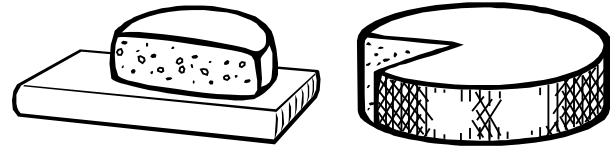

Alcuni formaggi
hanno un odore molto
sgradevole.



Il ghiaccio si è
sgretolato mentre
Osvaldo pattinava.

Leggi



I geli sgretolano
le rocce delle montagne.



L'intonaco si sgretola
a causa dell'umidità.

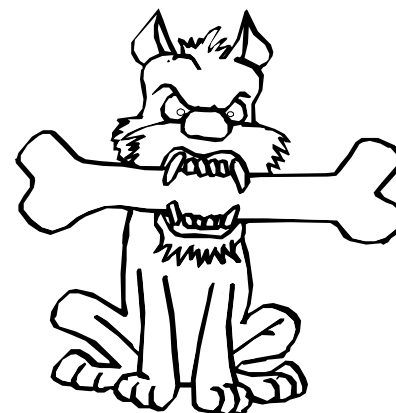

I cani sgretolano gli
ossi prima di inghiottirli.

Leggi



La maestra Brenda
ha sgridato gli alunni
che disturbavano
la lezione.



Per non essere sgridati
dai professori bisogna
comportarsi bene.



Non bisogna sgridare
spesso i bambini.

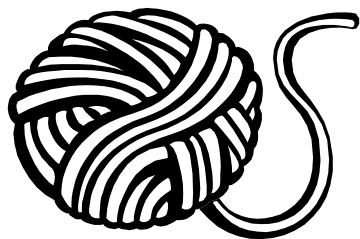

I gomitoli di lana vengono sgrovigliati dalla nonna per lavorare a maglia.

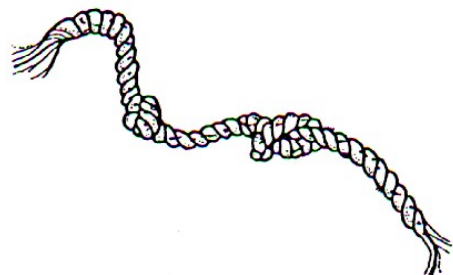

La corda si sta sgrovigliando lentamente.

Leggi



I giardinieri sgrossano le piante per togliere il superfluo.

Questa faccenda non si sgroviglierà senza il tuo prezioso aiuto.



Leggi e associa



Sgrossare

Sgridare

Sgretolare

Sgranocchiare

Leggi

Sgra sgre

Sgro sgrì

SGRI SGRA

Sgrì sgru

Sgrì sgre

sgru sgrì

Sgru sgrò

Sgrì sgre

Sgru sgrò

Sgra sgrì

Sgrò sgre

Sgre sgrì

O sgrò

E sgra

O sgrì

O sgre

I sgrò

u sgrì

O sgru

u sgrì

o sgra

a sgre

a sgra

i sgre

O sgru

A sgru

i sgrò

Leggi

Sgra sdre

sgro spri

SGRA STRI

sgro stre

sdri sgre

stra sgrì

spro sgrì

sdru sgre

sgro spre

sdra sgra

sgre sprà

sdro sgrì

O spro

E sgra

O stri

O sgrì

I stre

u sdra

O spri

u stra

o sgro

a spru

a sgrì

i stre

O spre

A sdru

i sgre

SFRA sfra *Sfra sfra*

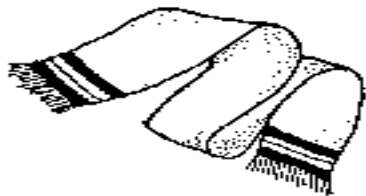

SFRE sfre *Sfre sfre*



SFRI sfri *Sfri sfri*



SFRANGIATA
sfrangiata

Sfrangiata
sfrangiata

SFREGIATO
sfregiato

Sfregiato
sfregiato

SFRIGOLARE
sfrigolare

Sfrigolare

SFRO sfro *Sfro sfro*



SFRONTATO

sfrontato

Sfrontato

sfrontato

SFRU sfru *Sfru sfru*

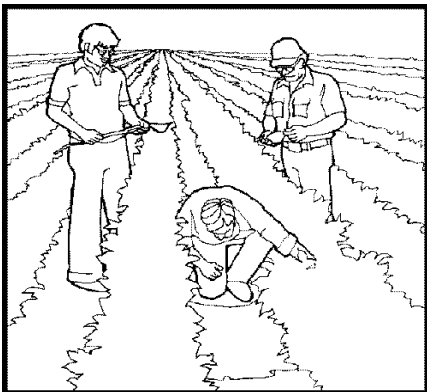

SFRUTTAMENTO

sfruttamento

Sfuttamento

sfruttamento

Cerca le **SFRA**

SFRA	SBA	QUA	SFRA	SFA	GLA
GUA	SDRA	SPRA	STRA	SGRA	SFRA
SFRA	FLA	SFRE	GNA	SPRA	SFRA

Cerca le **SFRE**

SFRE	SGRE	CHE	STRE	PRE	SFRE
SGHE	SFRE	SDRE	SFRE	SBE	FLE
SGRE	STRE	SFRA	GNE	SFRE	QUE

Cerca le **SFRI**

SFRI STRI SGHI SBI SPRI SDRI

SQUI SFRI SFRE SGRI GHI SFRI

Cerca le **SFRO**

STRO SBO SFRO QUO SDRO STRO

SFRI SFRO SGRO SFRO CRO SFO

Cerca le **SFRU**

SBU SFRO PRU SFRU STRU BLU

SFRU SDRU CRU SGRU GNU SFRU

Cerca le

sfra

stra

sdra

sfra

bla

sma

sfre

qua

sfra

sdra

sfa

sfra

sgra

sfri

spra

gna

gua

sfra

sba

Cerca le

sfre

sme

sfre

sbe

sgre

que

sghe

sfre

sbe

spre

sfra

che

sfre

stre

cle

sfre

stre

sfro

pre

Cerca le

sfri

sfri stri dri chi sdri qui

spri sfri sfre sgri ghi sfri

Cerca le

sfro

sgro gro sfro tro sbo sfra

sfro smo quo spro sfro sdro

Cerca le

sfru

sdru tru sfru sbu spru sfru

blu sfri stru sfru sgru flu 177

Cerca le *sfra*

qua sdra pla stra sfra sma sba sfra
pra gna sfi squa sfra sgra cla sfa
sfra sdra spra bla qua bra sfra squa

Cerca le *sfre*

stre che sbe sdre sfre ghe sque sfre
sche sfi pre gne sgre sghe ghe sdre
spre sfre sfra que sme sfre sque ple

Cerca le *sfri*

tri *sfri* *chi* *stri* *sfra* *ghi* *fli*

spri *sfre* *sbi* *sdri* *squi* *sfri* *spri*

Cerca le *sfro*

quo *blo* *sfro* *sgro* *stro* *bro* *sfre*

sfro *spro* *sdro* *sfro* *quo* *glo* *sgro*

Cerca le *sfri*

sgri *blu* *plu* *sfri* *sbu* *gnu* *stru*

sdru *sfro* *gru* *sfri* *flu* *sfri* *sdru*

Cerca le *Sfra*

Squa Sfra Sba Fra Sdra Qua Dra Sfra

Gna Cla Sfri Gla Sgra Spra Sfra Fla

Tra Sfra Gua Bra Stra Sva Sfro Fra

Cerca le *Sfre*

Sfre Che Tre Ghe Sfre Sdre Sgre

Cre Sfre Gre Sfra Sche Sme Sque

Stre Gne Sfri Stre Pre Sfro Ghe

Cerca le *Sfri*

Gri Sfri Chi Stri Sfra Fri Qui Gni

Sgri Sdri Ghi Sfri Spri Sfri Stri Cri

Cerca le *Sfro*

Stro Sfro Tro Sgro Fro Sfri Spro Gno

Quo Sdro Gno Sfre Stro Plo Sfro Clo

Cerca le *Sfru*

Sfru Sbu Stru Plu Sdru Sgru Sfra

Spru Cru Plu Sfru Sfu Flu Spu

Leggi

SFRA

sfra

Sfra

Sfra

sfra

sfre

Sfre

Sfre

SFRE

sfre

Sfri

sfri

SFRI

Sfri

sfri

Sfro

sfro

Sfro

SFRO

sfro

Sfru

Sfru

SFRU

sfru

sfru

Leggi

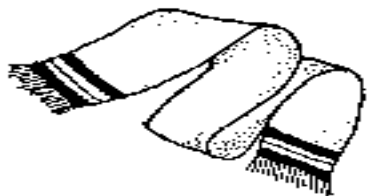

Una sciarpa sfrangiata

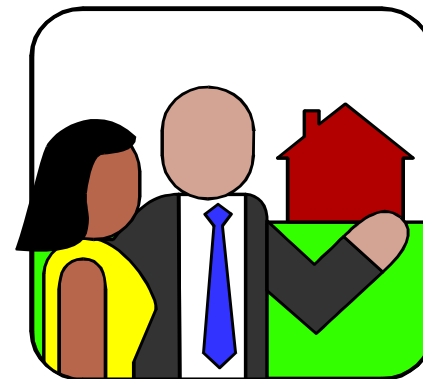

Persone sfrattate



Sfrigolare



Un uomo sfregiato

Leggi



Un albero sfrondato

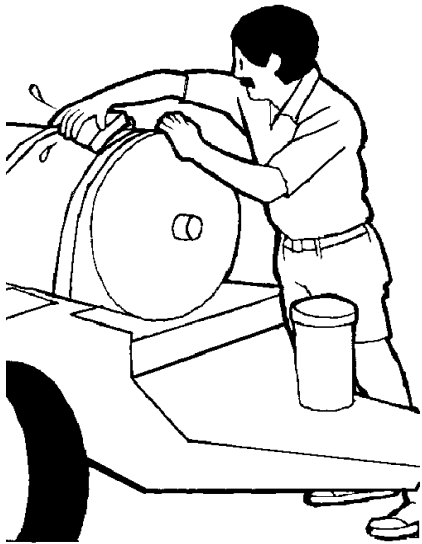

Sfregare

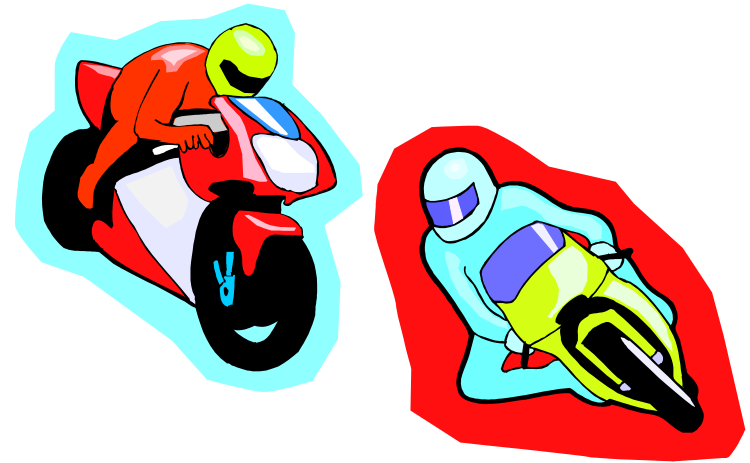

Sfrecciare



Persone sfrontate

Leggi

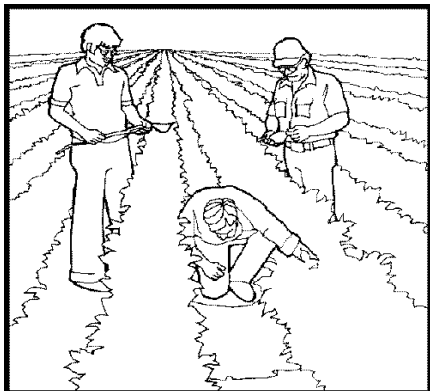

Persone sfruttate

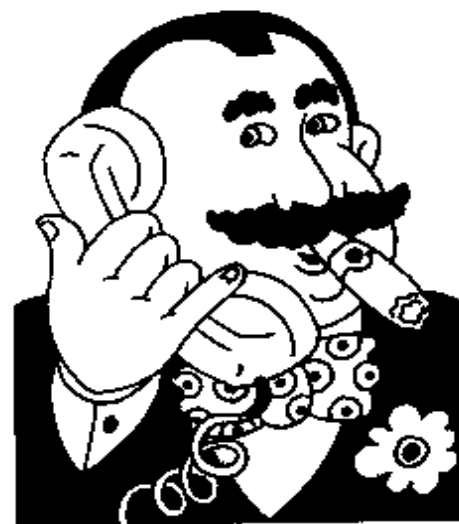

Sfruttatore



Gli inquilini morosi
sono stati sfrattati
dalla loro casa.

Prima di uscire
Flavia controlla
il suo armadio
e decide di indossare
una sciarpa sfrangiata.



Leggi



Gli sfrattati cercano una
nuova sistemazione.

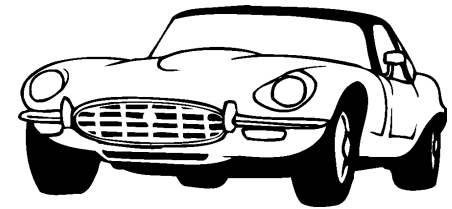

La macchina
di Michele si
è sfracellata
nel torrente.

Leggi

Claudio e Grazia
sono ballerini
professionisti
e quando si
esibiscono
ballano in modo sfrenato.



L'operaio specializzato
ha il compito di
sfregare il ferro
per renderlo
più liscio.



Franco a causa di
un incidente ha il
volto sfregiato.

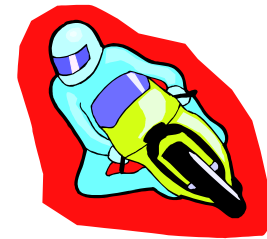

Durante la gara
i motociclisti
sfrecciano sulla pista.

Leggi

Quando la mamma
prepara le
patatine fritte
l'olio bollente
sfrigola nella padella.

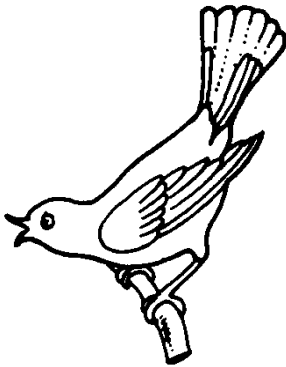
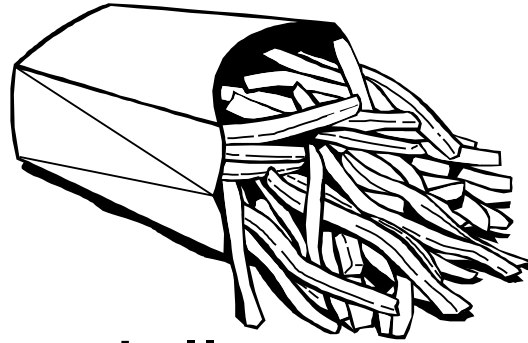

Il fringuello sfringuellava
allegramente.

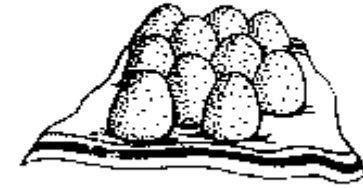

Per preparare gli
arancini l'olio
deve sfrigolare.

Lo sfrido che hanno
i negozianti
di frutta
è davvero
notevole.

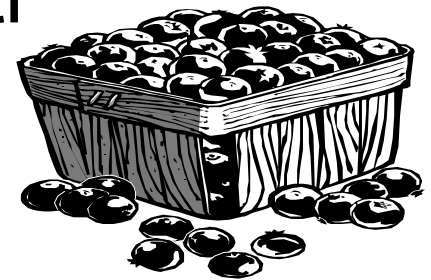



Questo albero
è stato sfrondato
dai rami superflui.



Quei due che ballano
sono proprio sfrontati.

Leggi

Non bisogna
essere
né troppo
timidi ma
neanche
troppo sfrontati.



Secondo me Lucrezia
è proprio sfrontata!



Leggi

Non è né corretto
né giusto sfruttare
la generosità altrui.

Patrizia
ha sfruttato
bene
lo spazio
della sua stanza.

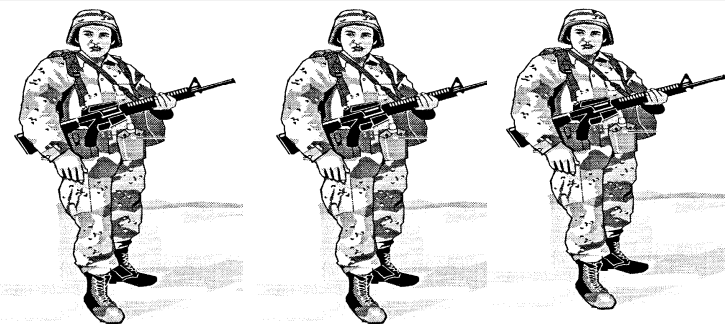

Durante la guerra
l'esercito nemico
ha sfruttato la sua
superiorità numerica.



Lo sfruttatore approfitta
delle debolezze altrui.

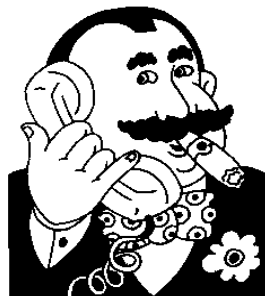
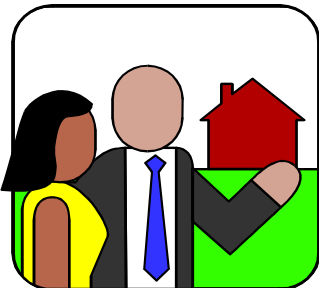

Leggi e associa

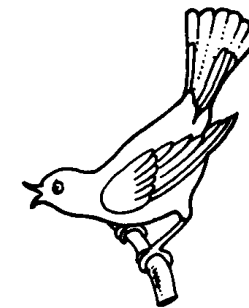
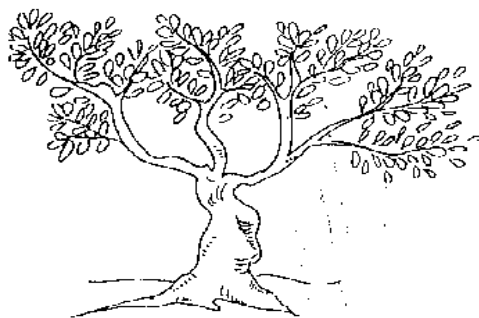

Sfringuellare

Un albero sfrondato

Persone sfrattate

Sfrecciare

Sfruttatore

Leggi

Sfra sfre Sfro sfri SFRI SFRA *Sfri sfu*

Sfri sfre *sfu sfri* Sfru sfro *Sfri sfre*

Sfu sfrò Sfra sfri *Sfro sfre* Sfre sfri

O sfro E sfra O sfri *O sfre* I sfro

u sfri *O sfu* u sfri o sfra a sfre

a sfra i sfre *O sfu* A sfru i sfro

Leggi

<i>Sfra sdre</i>	sfro spri	SPRA SFRI	<i>sfro sgre</i>
sfri sdre	<i>sfra spri</i>	sfro sgri	sfro sdre
<i>sdro sfro</i>	sfra sgra	<i>spre sfro</i>	sfro sgri

O sfro	E sfra	O sdri	<i>O sgri</i>	I sdre
<i>u sprra</i>	<i>O sfru</i>	u sdra	o sfro	a spro
<i>a sfre</i>	i spre	<i>O sgre</i>	A sgru	i sfri

SFRA come ...

SFRE come ...
sfre come ...

