

# SVILUPPO CULTURALE E DEL LINGUAGGIO

*Emidio Tribulato*



Volume 9

**Emidio Tribulato**

# SVILUPPO CULTURALE E DEL LINGUAGGIO

Centro studi *LOGOS* – ONLUS - Messina



2010- Tutti i diritti riservati.

Sito web: [www.cslogos.it](http://www.cslogos.it) – E - mail: [postmaster@cslogos.it](mailto:postmaster@cslogos.it)

## I SINONIMI CON IMMAGINI

In queste schede il bambino dovrà associare ogni parola con il rispettivo sinonimo. Per facilitare il riconoscimento del significato, ogni parola è stata corredata da un'immagine.

Quest'attività gli potrà permettere di esercitarsi nella lettura, di acquisire un vocabolario più ricco di termini e di migliorare la comprensione di quelli già appresi.

### UTILIZZAZIONE

#### *SCELTA MULTIPLA INCROCIATA*

Per stimolare l'apprendimento s'inviterà il bambino a leggere, le parole sotto le immagini che si trovano nella parte sinistra della scheda collegandole con i sinonimi che si trovano nella parte destra.

In quest'attività il bambino sarà facilitato dalle immagini e dal sistema di risposta a scelta multipla incrociata, che gli permetterà di collegare, per esclusione, anche i termini che non conosce, poiché potrà iniziare da quelli a lui noti.

#### SCELTA APERTA

In un secondo tempo, coprendo la parte destra della scheda, il bambino dovrà dire un sinonimo della parola letta anche se diverso da quello presente nella scheda.

### ETÀ DI RIFERIMENTO

Sviluppo linguistico ed intellettuale di almeno sei anni.

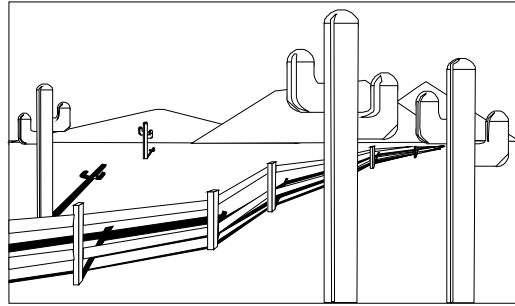

AFFOLLARE

AFOSO

GREMIRE

CALDO



AGENDA

TACCUINO

I SINONIMI

Far associare ogni termine con il proprio sinonimo.

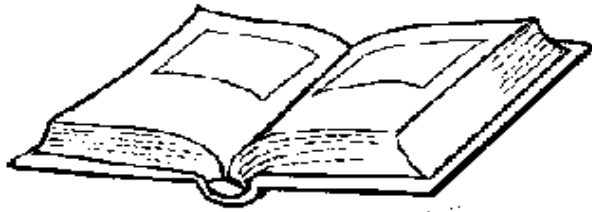

VOCABOLARIO



VUOTA



VORACE

VACANTE

DIZIONARIO

GOLOSO

I SINONIMI

Far associare ogni termine con il proprio sinonimo.



AGENTE

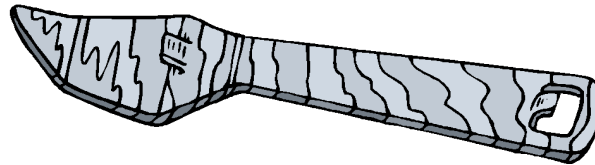

AGGEGGIO

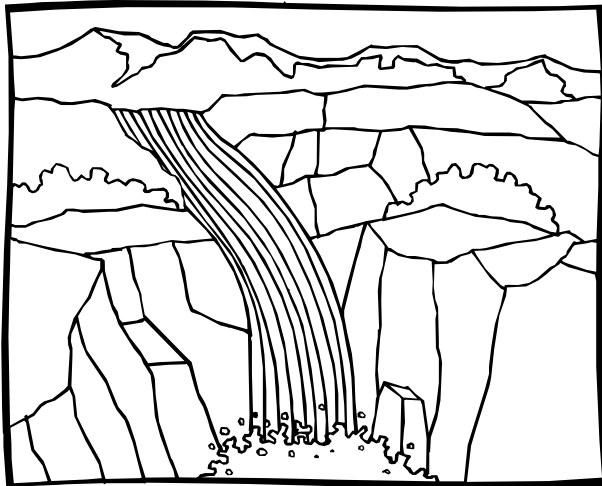

ALLAGARE

INCARICATO

OGGETTO

INONDARE

I SINONIMI

Far associare ogni termine con il proprio sinonimo.



ESCA

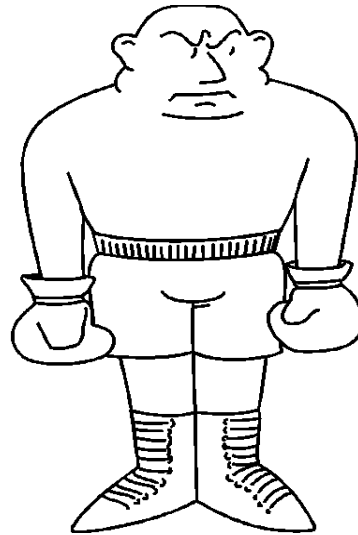

COLOSSO



FUGGIRE

EVADERE

TRAPPOLA

ERCOLE

I SINONIMI

Far associare ogni termine con il proprio sinonimo.



VANDALO

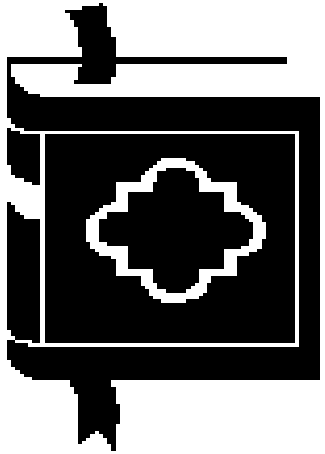

VANGELO

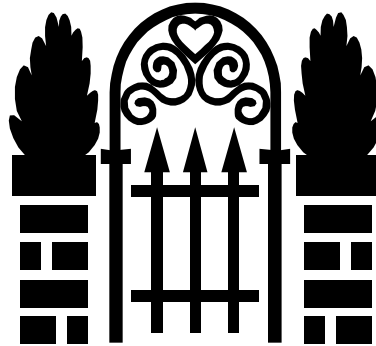

VARCO

APERTURA

SELVAGGIO

SCRITTURA

I SINONIMI

Far associare ogni termine con il proprio sinonimo.



NAVE

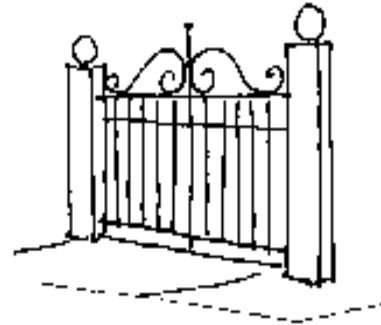

INGRESSO

DOCENTE

ENTRATA

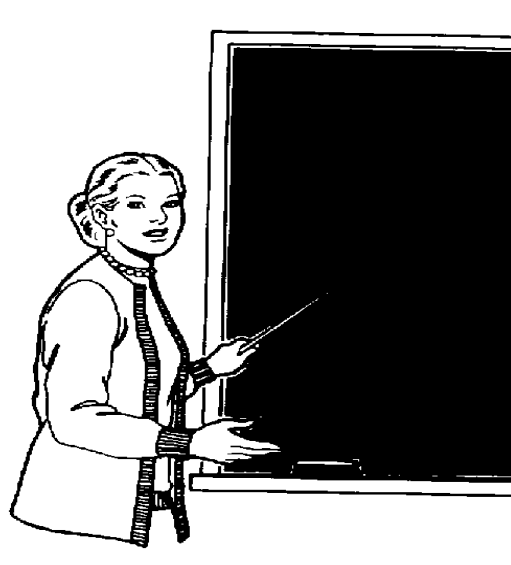

INSEGNANTE

IMBARCAZIONE

### I SINONIMI

Far associare ogni termine con il proprio sinonimo.

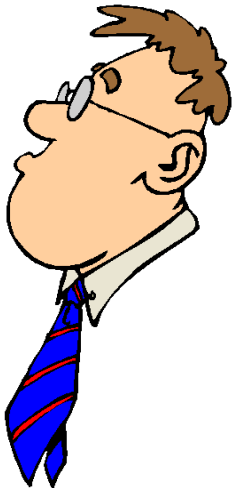

GUARDARE

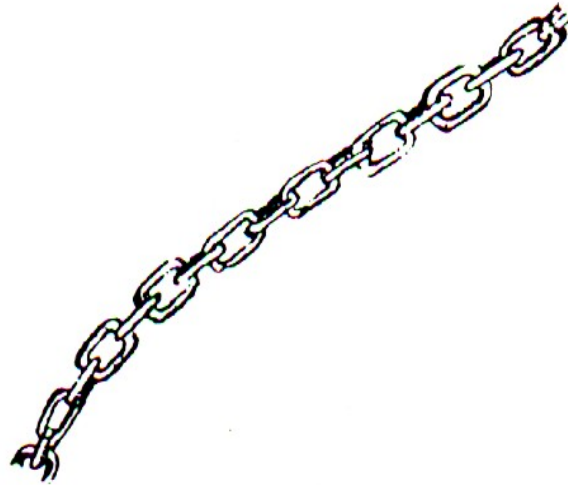

CATENA

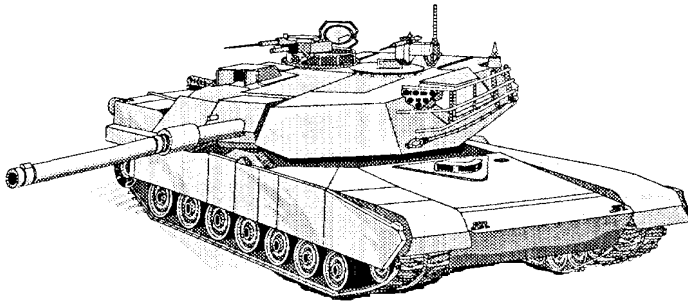

GUERRA

LOTTA

GUINZAGLIO

OSSERVARE

### I SINONIMI

Far associare ogni termine con il proprio sinonimo.

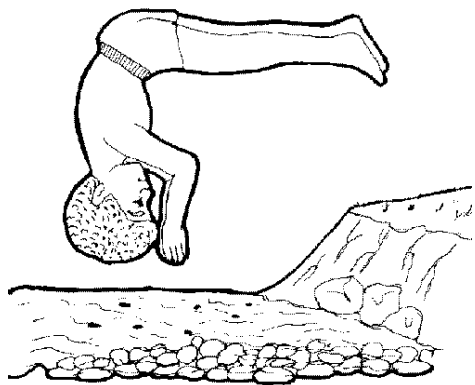

TUFFO



TRASPORTARE



UBBIDIENTE

TRASFERIRE

DOCILE

IMMERSIONE

### I SINONIMI

Far associare ogni termine con il proprio sinonimo.

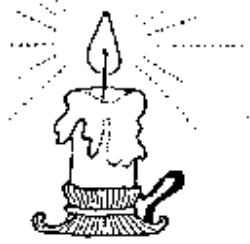

CANDELA



TRAVESTIMENTO



TRONO

TORCIA

TRUCCO

PODIO

I SINONIMI

Far associare ogni termine con il proprio sinonimo.



TRAMONTO

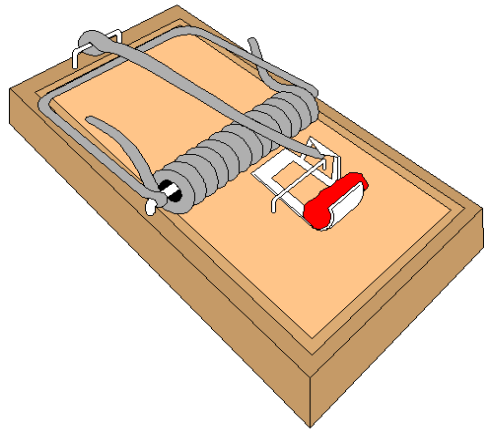

TRAPPOLA



FUSTO

TRONCO

TRANELLO

SERA

I SINONIMI

Far associare ogni termine con il proprio sinonimo.



TESTA

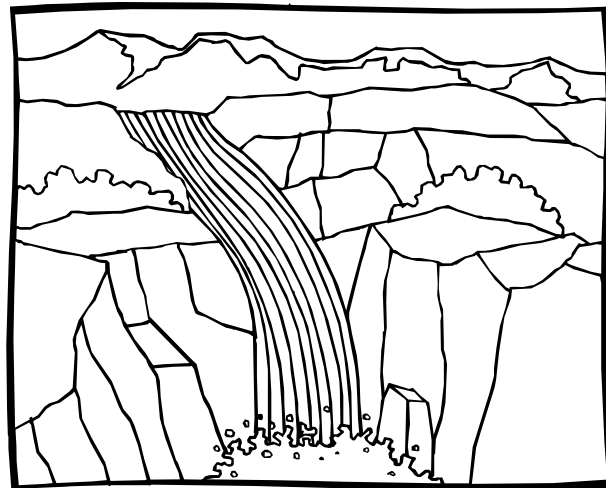

TORRENTE



TORNEO

RUSCELLO

CAPO

COMPETIZIONE

### I SINONIMI

Far associare ogni termine con il proprio sinonimo.



CATTURARE



CHIAMATA

FORBICI

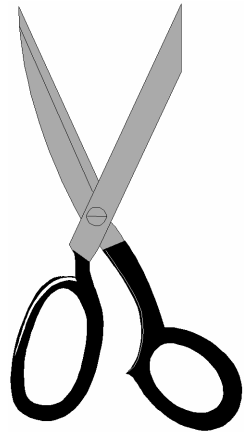

CESOIE

ACCIUFFARE

CONVOCAZIONE

### I SINONIMI

Far associare ogni termine con il proprio sinonimo.



TRISTEZZA

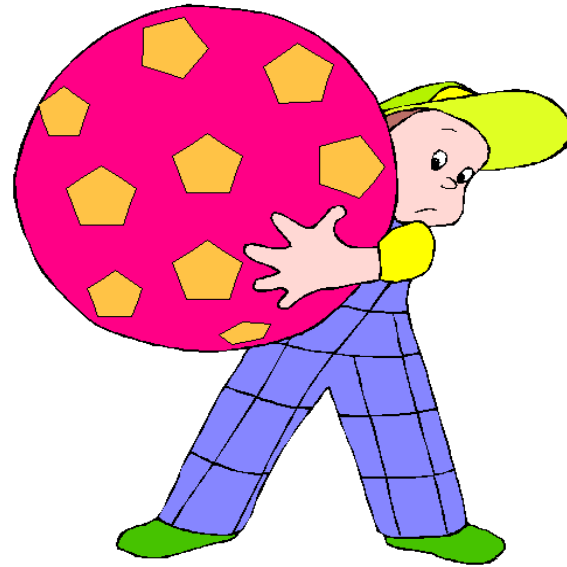

BALOCO

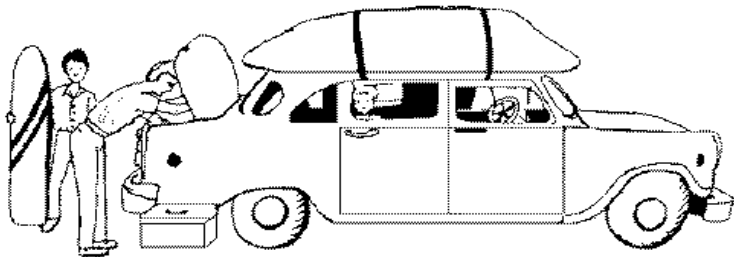

TURISTA

DISPIACERE

GIOCATTOLO

VIAGGIATORE

I SINONIMI

Far associare ogni termine con il proprio sinonimo.



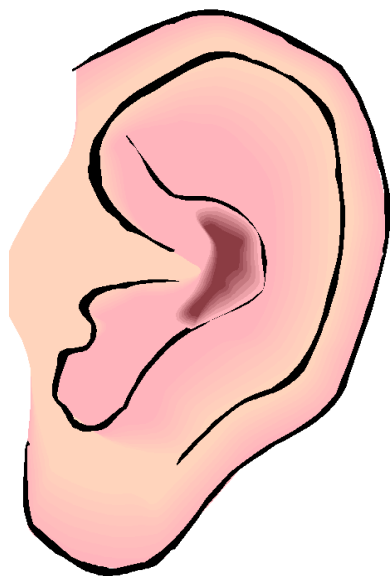

UDIRE



UOMO



UMIDO

BAGNATO

PERSONA

SENTIRE

I SINONIMI

Far associare ogni termine con il proprio sinonimo.



POETA

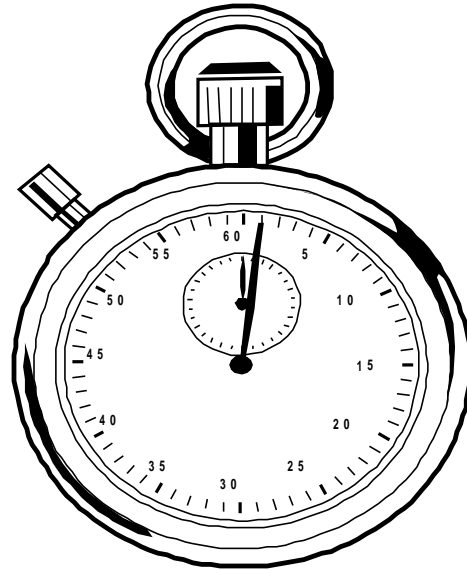

PUNTUALE

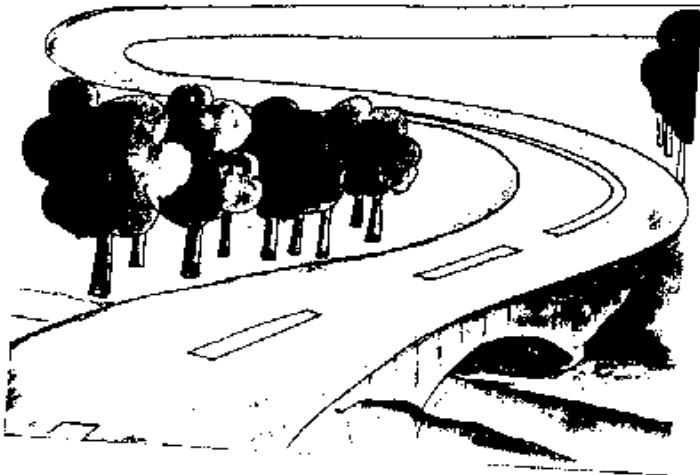

PISTA

PRECISO

TRACCIATO

ARTISTA

I SINONIMI

Far associare ogni termine con il proprio sinonimo.

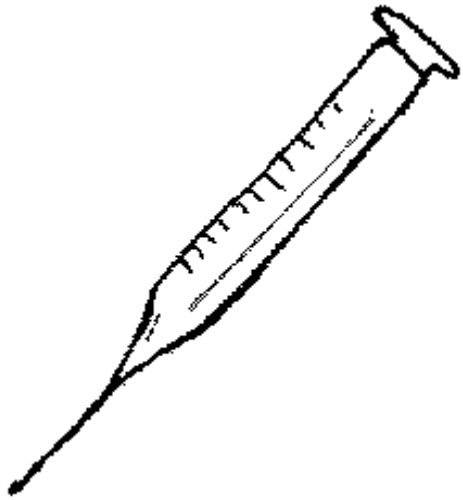

PUNTURA

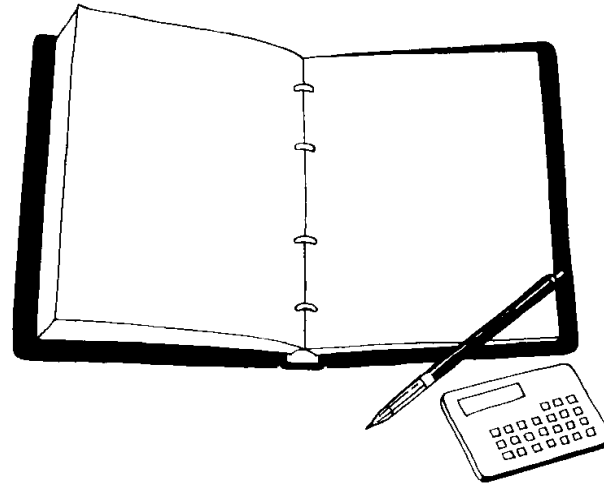

QUADERNO

INIEZIONE

AGENDA



QUADRO

DIPINTO

### I SINONIMI

Far associare ogni termine con il proprio sinonimo.



PENNA



PESO

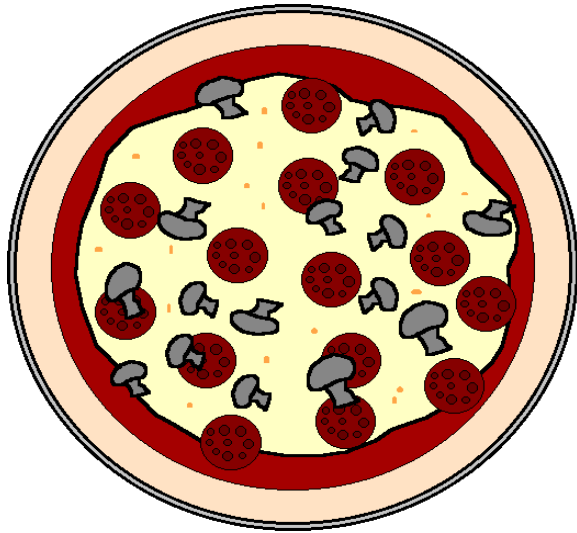

PIZZA

STILO

FOCACCIA

MISURA

I SINONIMI

Far associare ogni termine con il proprio sinonimo.



BRILLANTE

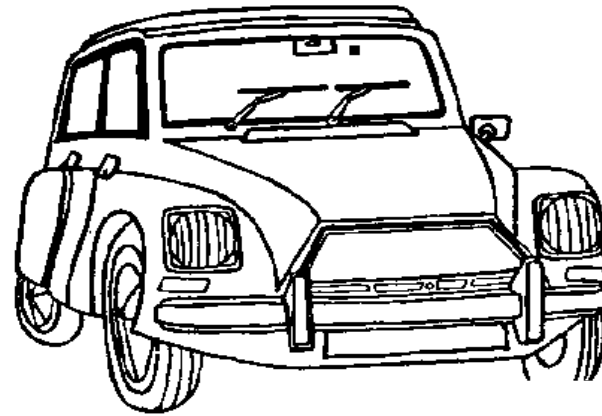

MACCHINA



LUOGO

POSTO

LUCIDO

AUTO

### I SINONIMI

Far associare ogni termine con il proprio sinonimo.



LETTURA



LEVARE



LEGARE

ANNODARE

ELIMINARE

TESTO

### I SINONIMI

Far associare ogni termine con il proprio sinonimo.

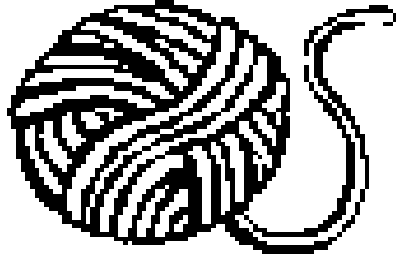

FIBRA



ANSIA

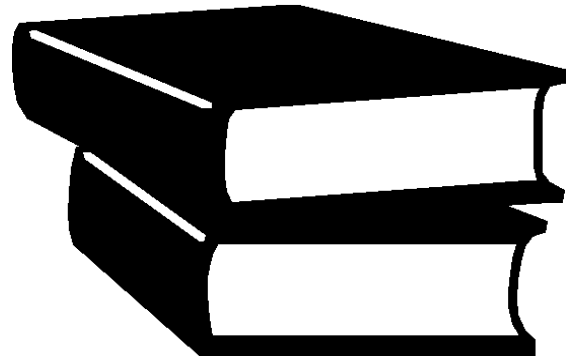

VOCABOLARIO

PREOCCUPAZIONE

GLOSSARIO

FILO

I SINONIMI

Far associare ogni termine con il proprio sinonimo.

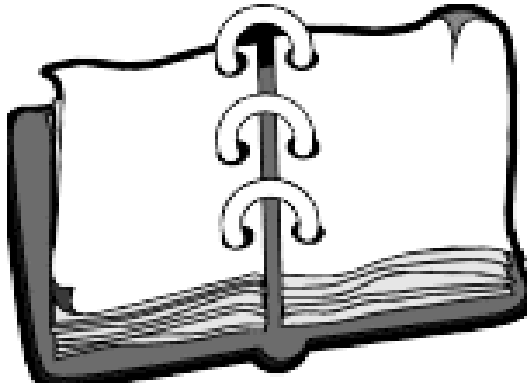

ELENCO



ENTUSIASMO

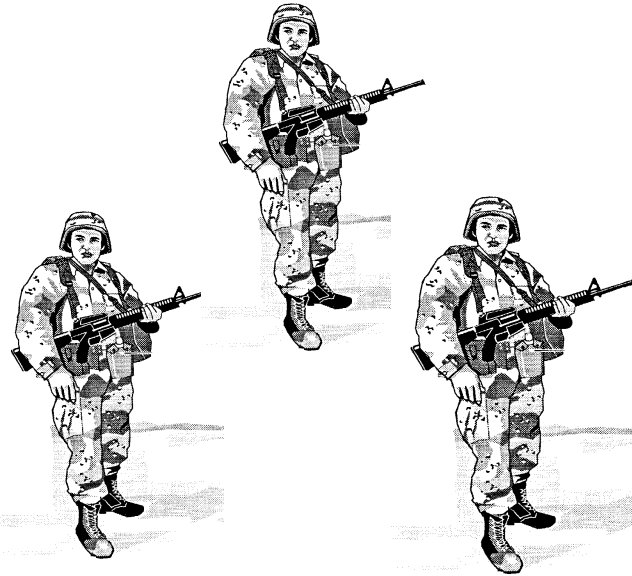

TRUPPA

ESERCITO

LISTA

ALLEGRIA

I SINONIMI

Far associare ogni termine con il proprio sinonimo.





MACIGNO



MAGIA

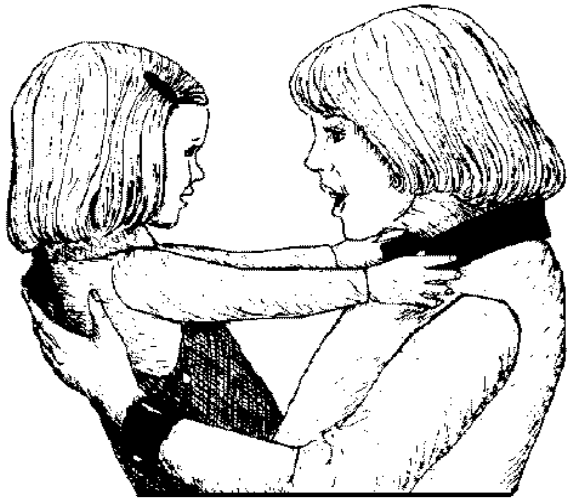

MADRE

SASSO

GENITRICE

INCANTESIMO

I SINONIMI

Far associare ogni termine con il proprio sinonimo.



MAESTÀ



MAGLIA



GRACILE

CANOTTA

RE

MAGRO

### I SINONIMI

Far associare ogni termine con il proprio sinonimo.

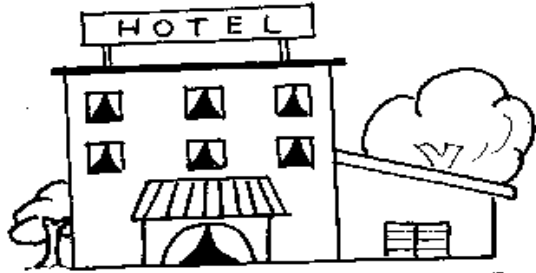

ALBERGO

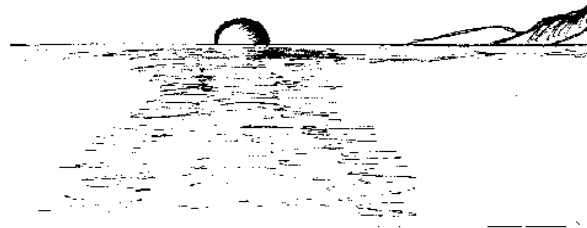

ALBA



ALIMENTAZIONE

AURORA

CIBO

PENSIONE

### I SINONIMI

Far associare ogni termine con il proprio sinonimo.

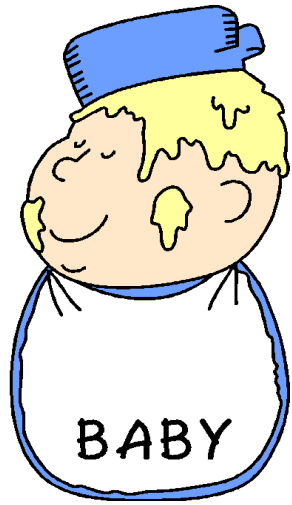

SAZIO

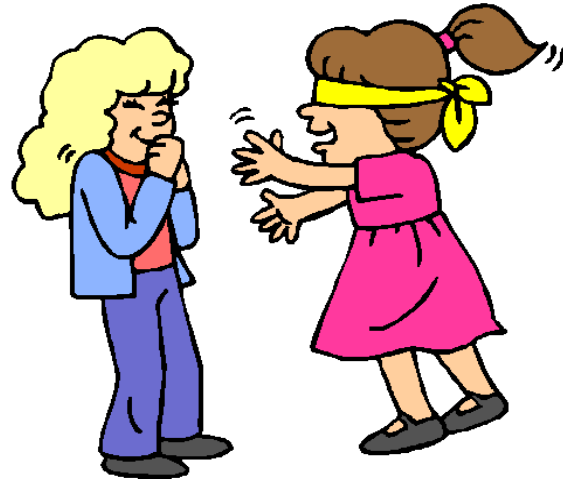

SCHERZO



RISCALDARE

SCALDARE

PIENO

BURLA

I SINONIMI

Far associare ogni termine con il proprio sinonimo.



FONTE

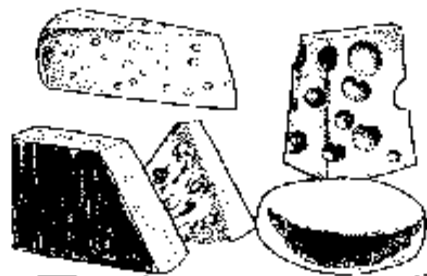

FORMAGGIO

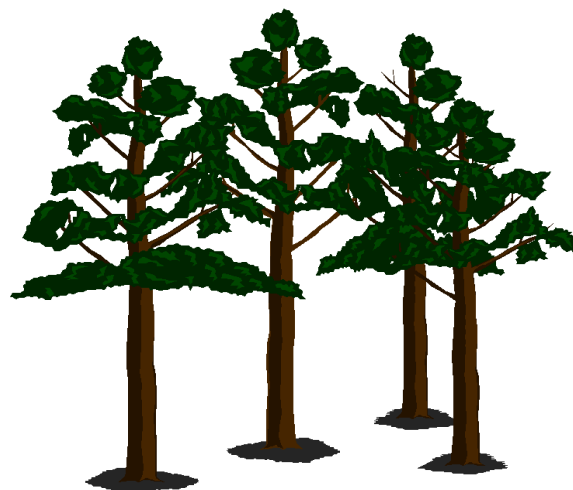

FORESTA

GIUNGLA

CACIO

SORGENTE

### I SINONIMI

Far associare ogni termine con il proprio sinonimo.

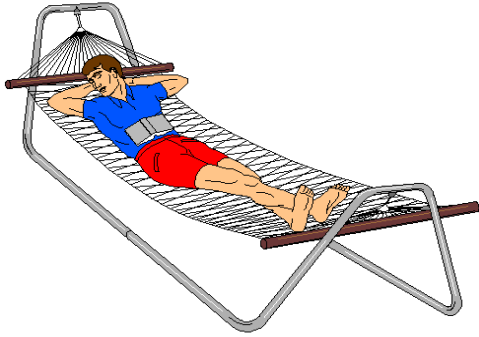

RILASSANTE



ROTTA

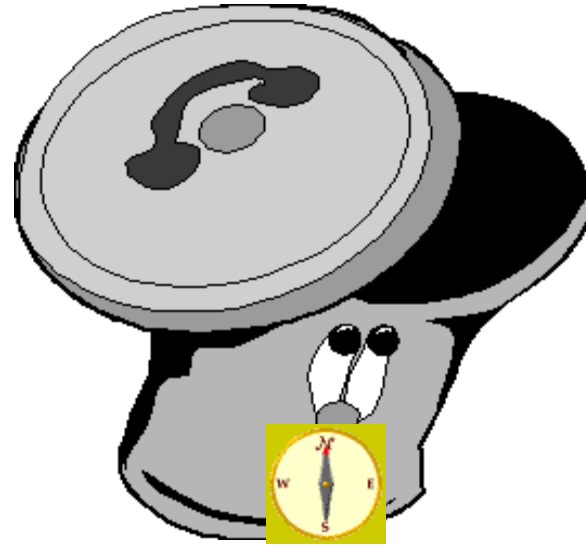

SPAZZATURA

RIFIUTI

DIREZIONE

CALMANTE

I SINONIMI

Far associare ogni termine con il proprio sinonimo.

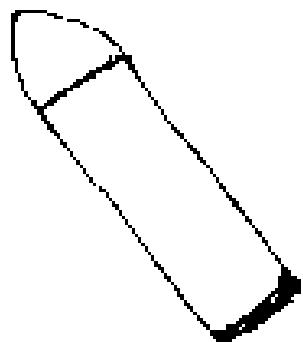

PROIETTILE

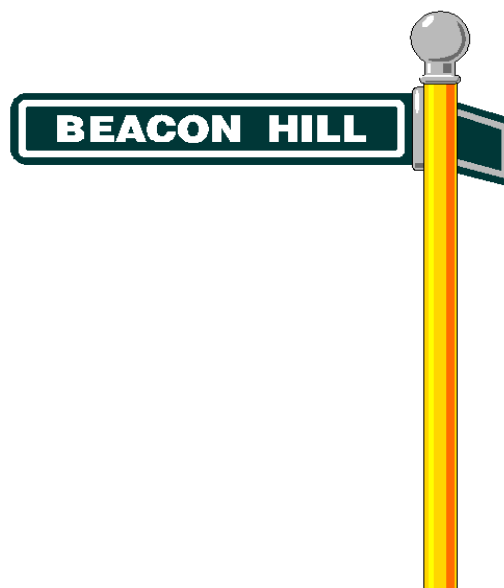

PALO

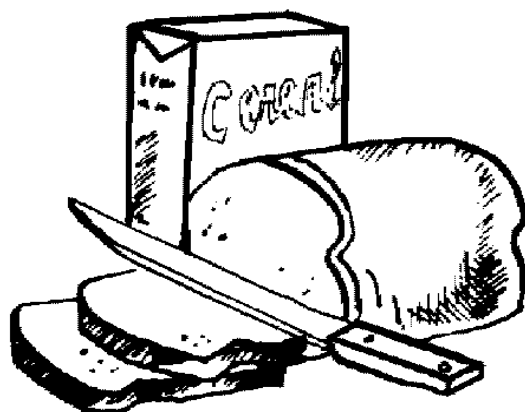

PANE

PALLOTTOLA

SOSTEGNO

ALIMENTO

### I SINONIMI

Far associare ogni termine con il proprio sinonimo.

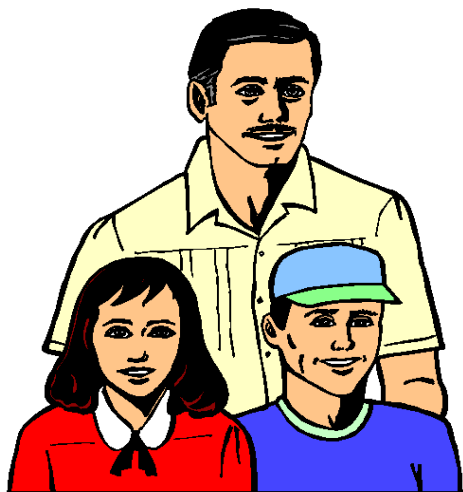

PADRE



PAFFUTO



PADRONE

GRASSOTTELLO

GENITORE

PROPRIETARIO

### I SINONIMI

Far associare ogni termine con il proprio sinonimo.



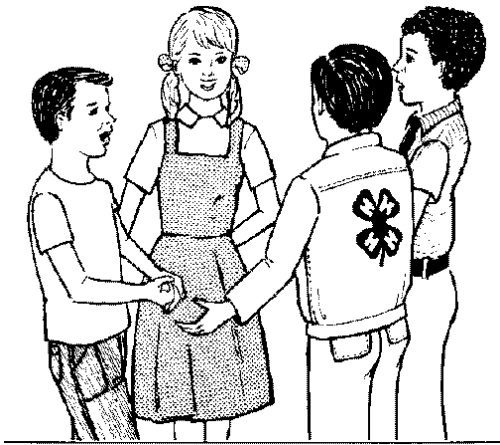

DIALOGARE

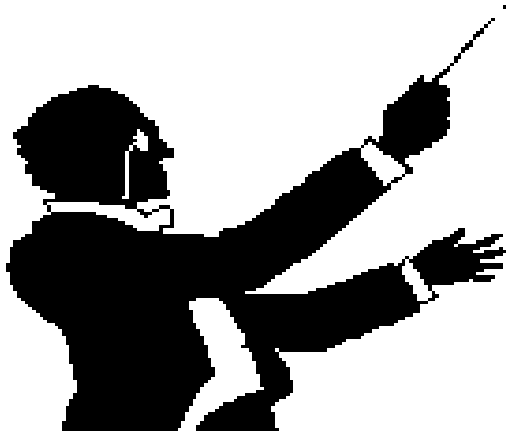

DIRETTORE



DIFESA

TUTELA

COMUNICARE

MAESTRO

I SINONIMI

Far associare ogni termine con il proprio sinonimo.

TESSUTO



PANNO

RICCHEZZA



TORRE



TESORO

CAMPANILE

I SINONIMI

Far associare ogni termine con il proprio sinonimo.

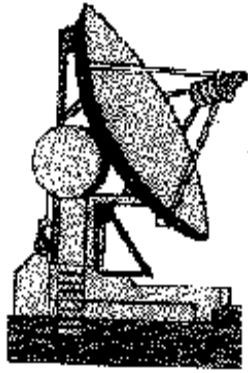

PARABOLA

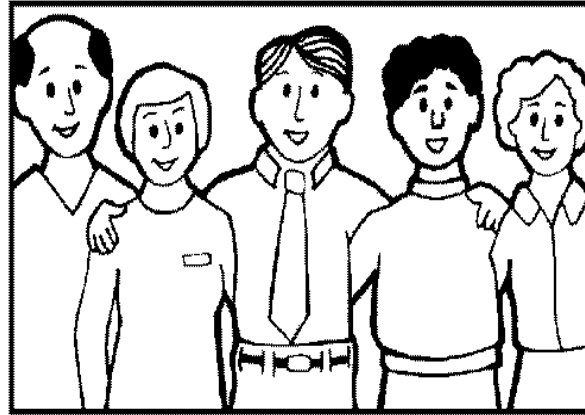

FRATELLANZA

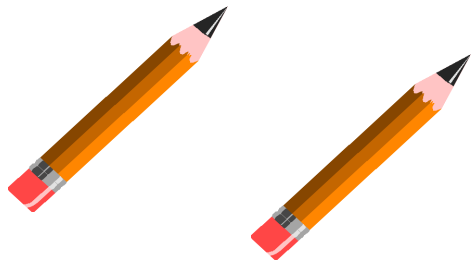

UGUALI

ANTENNA

PACE

IDENTICHE

### I SINONIMI

Far associare ogni termine con il proprio sinonimo.



EDUCATORE

COSTRUZIONE

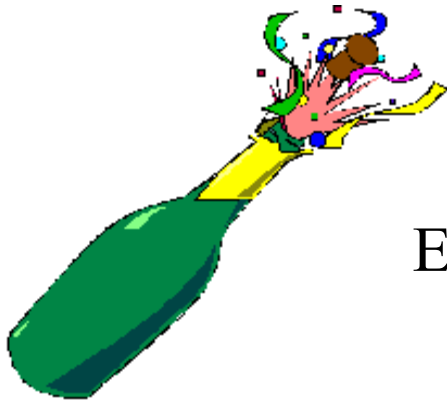

EFFERVESCENTE

EDIFICIO

GUIDA

FRIZZANTE

I SINONIMI

Far associare ogni termine con il proprio sinonimo.



FUGGIRE



GABBIA



GAZZETTA

GIORNALE

SCAPPARE

PRIGIONE

I SINONIMI

Far associare ogni termine con il proprio sinonimo.

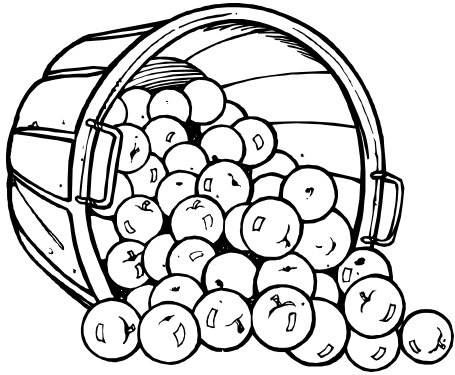

QUANTITÀ



QUESTIONE



QUARTIERE

CIFRA

DOMANDA

ZONA

I SINONIMI

Far associare ogni termine con il proprio sinonimo.

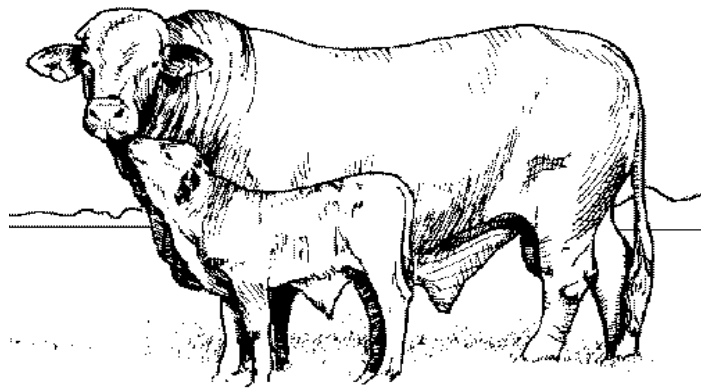

MUCCA



VERDURA



VECCHIO

ANTICO

VACCA

INSALATA

I SINONIMI

Far associare ogni termine con il proprio sinonimo.



PAUROSOSO



TAZZA

CIOTOLA

APPARECCHIO

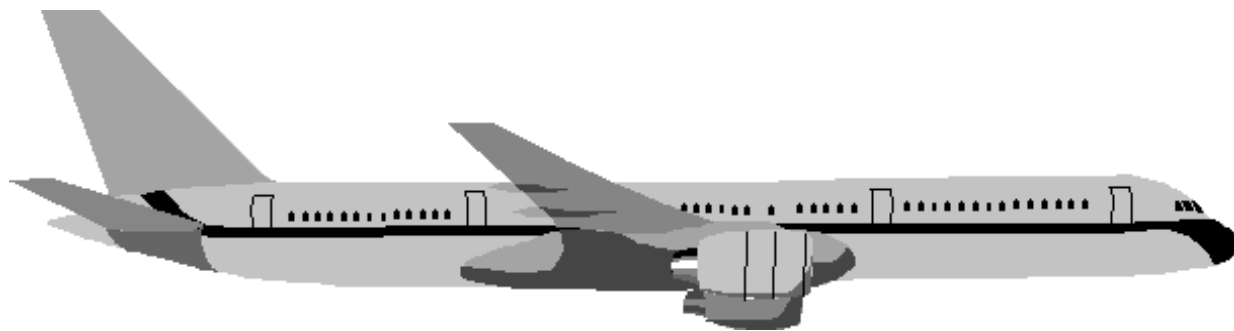

AEREO

TERRIBILE

### I SINONIMI

Far associare ogni termine con il proprio sinonimo.





TAPPO

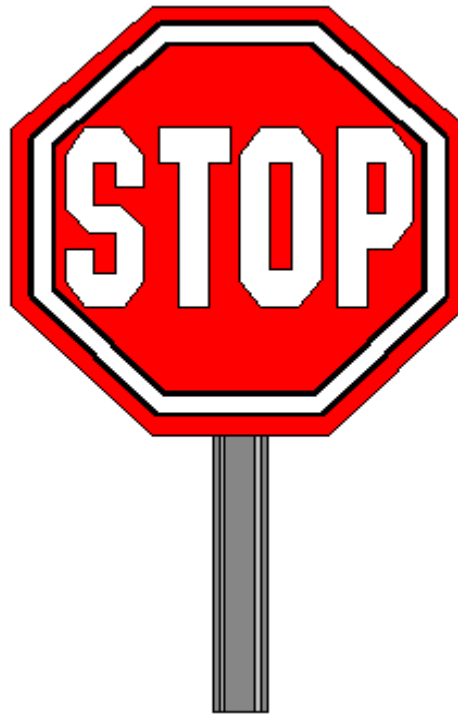

CARTELLO

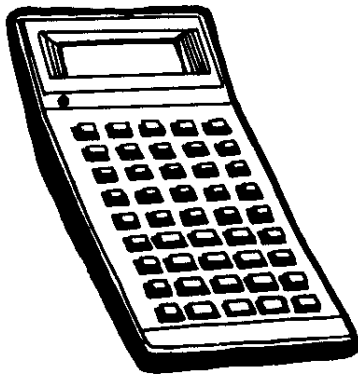

TASTI

COPERCHIO

SEGNALE

PULSANTI

I SINONIMI

Far associare ogni termine con il proprio sinonimo.



ALPINISTA



AMBASCIATORE



ANCELLA

ROCCIATORE

SERVA

MESSAGGERO

I SINONIMI

Far associare ogni termine con il proprio sinonimo.



ALLEGRO

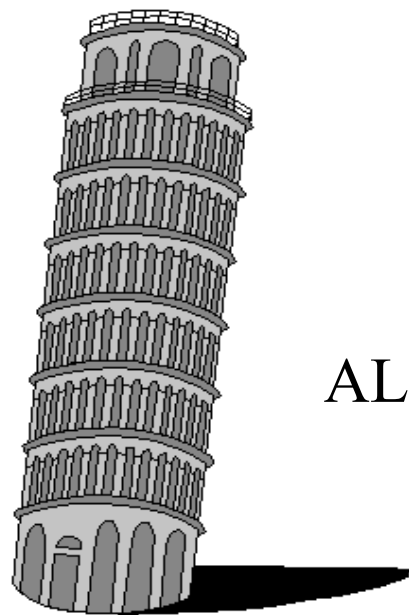

ALTO



ALLENAMENTO

CONTENTO

ELEVATO

ADDESTRAMENTO

### I SINONIMI

Far associare ogni termine con il proprio sinonimo.



ARDERE

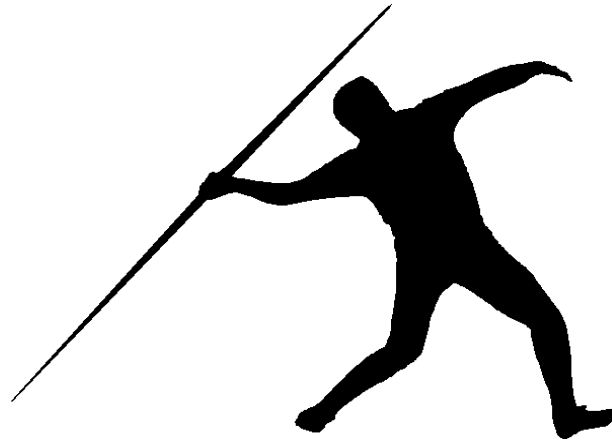

LANCIARE

BRUCIARE

BUTTARE

BOVE

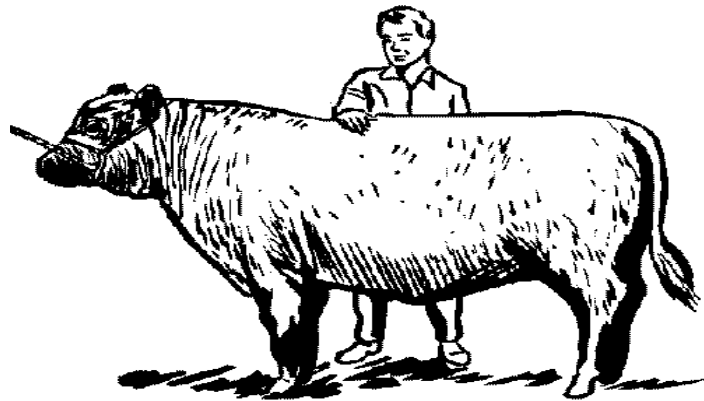

BUE

### I SINONIMI

Far associare ogni termine con il proprio sinonimo.

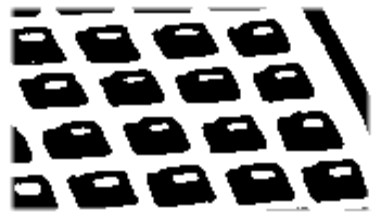

BOTTONE



BOTTO

ESPLOSIONE

SCINTILLARE



BRILLARE

PULSANTE

### I SINONIMI

Far associare ogni termine con il proprio sinonimo.

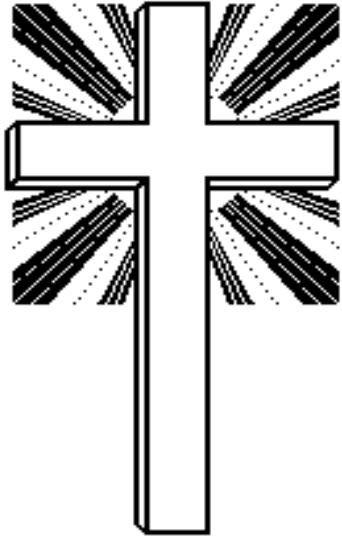

RELIGIONE



RESIDENZA



PREMIO

FEDE

RICOMPENSA

CASA

I SINONIMI

Far associare ogni termine con il proprio sinonimo.



PARLARE



BARBIERE

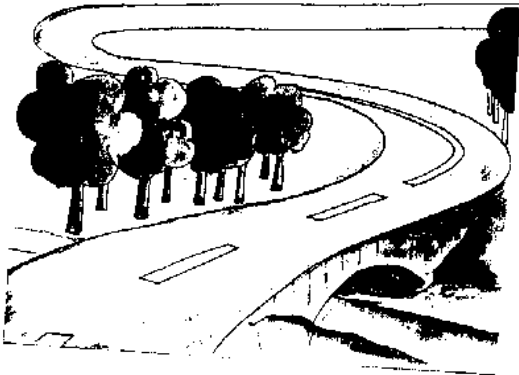

PERCORSO

PARRUCCHIERE

STRADA

COMUNICARE

### I SINONIMI

Far associare ogni termine con il proprio sinonimo.

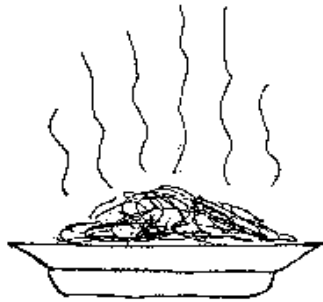

CIBO



PARCO



PARETE

VILLA

PAPPA

MURO

### I SINONIMI

Far associare ogni termine con il proprio sinonimo.



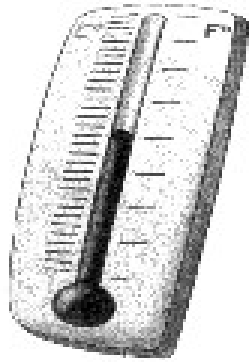

MISURARE



MODELLARE

AZIONE



CREARE

MOTO

STIMARE

### I SINONIMI

Far associare ogni termine con il proprio sinonimo.

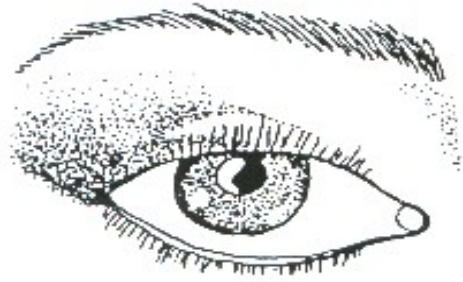

OCCHIO



ODORARE



PACCO

VISTA

CONFEZIONE

FIUTARE

I SINONIMI

Far associare ogni termine con il proprio sinonimo.



FARO



FATA



FERMARE

MAGA

LUCE

BLOCCARE

### I SINONIMI

Far associare ogni termine con il proprio sinonimo.

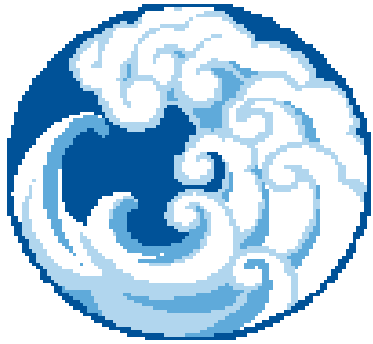

ONDA



ORIENTARE



ORCHESTRA

CAVALLONE

COMPLESSO

INDIRIZZARE

### I SINONIMI

Far associare ogni termine con il proprio sinonimo.

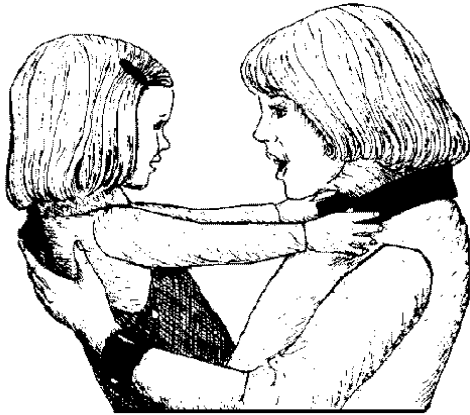

OBBEDIENTE

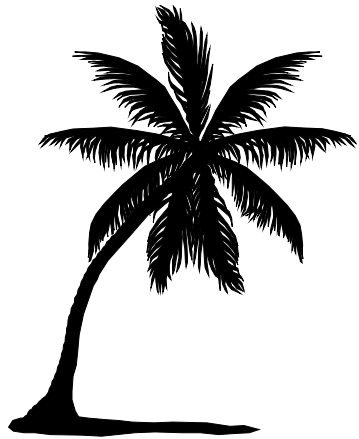

OMBRA

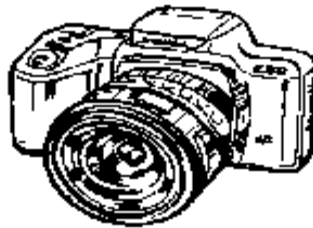

OBIETTIVO

OSCURITÀ

DISCIPLINATO

LENTE

### I SINONIMI

Far associare ogni termine con il proprio sinonimo.



SANTO

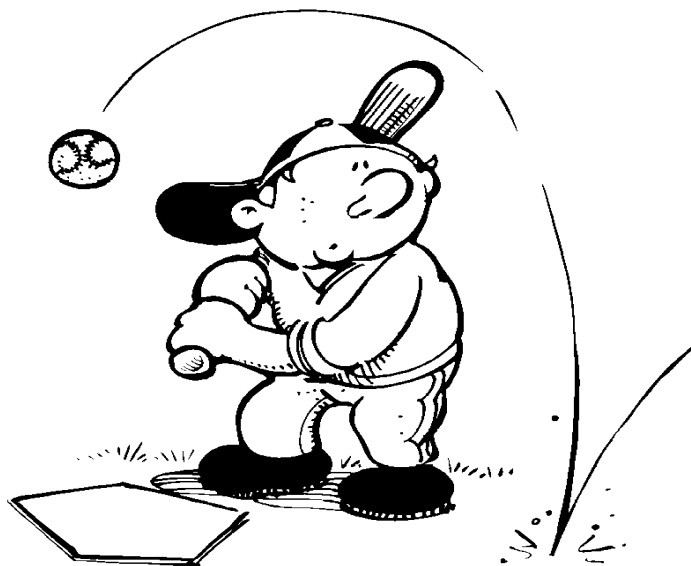

SBADATO

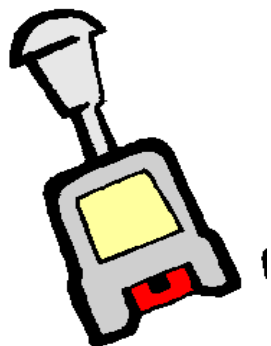

TIMBRO

MARCHIO

BENEDETTO

DISATTENTO

### I SINONIMI

Far associare ogni termine con il proprio sinonimo.

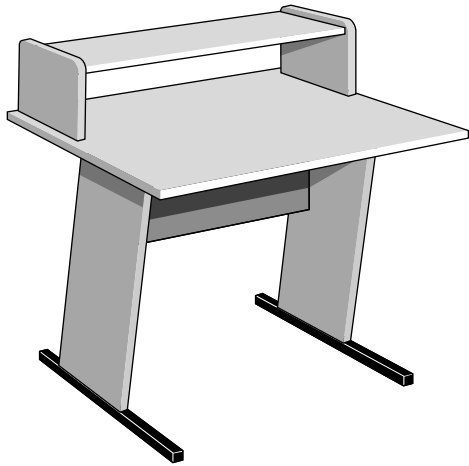

SCRIVANIA



SORRISO



VINO

FELICITÀ

SPUMANTE

BANCO

I SINONIMI

Far associare ogni termine con il proprio sinonimo.



NAZIONE



NERO

STATO

TANA

SCURO



NIDO

### I SINONIMI

Far associare ogni termine con il proprio sinonimo.



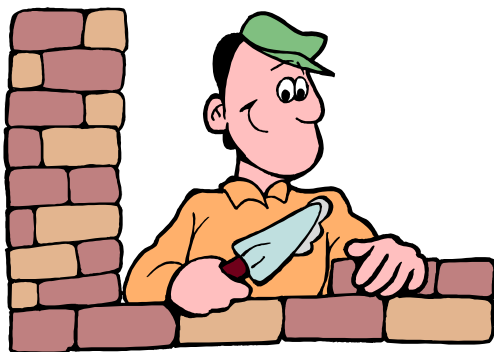

MURATORE

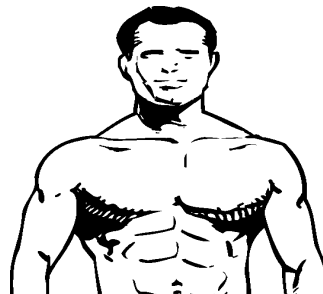

MUSCOLOSO



NANO

OPERAIO

BASSO

FORTE

I SINONIMI

Far associare ogni termine con il proprio sinonimo.



MAPPA



MARE



MASCHERA

CARTA

COSTUME

OCEANO

I SINONIMI

Far associare ogni termine con il proprio sinonimo.

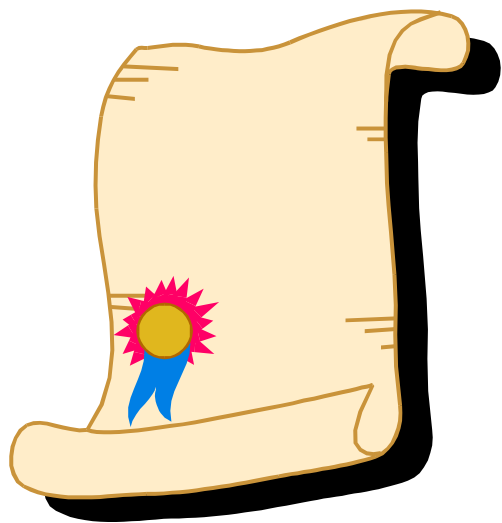

MEDAGLIA

MERENDA



MERAVIGLIA



SPUNTINO

SORPRESA

PREMIO

### I SINONIMI

Far associare ogni termine con il proprio sinonimo.

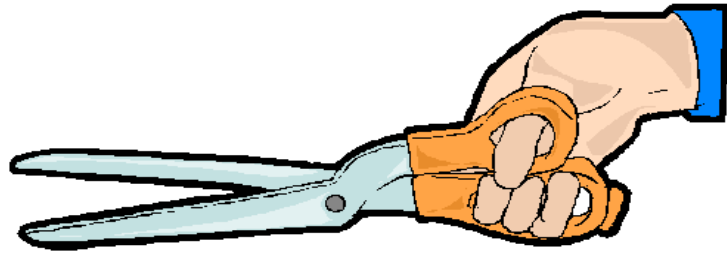

STRUMENTO

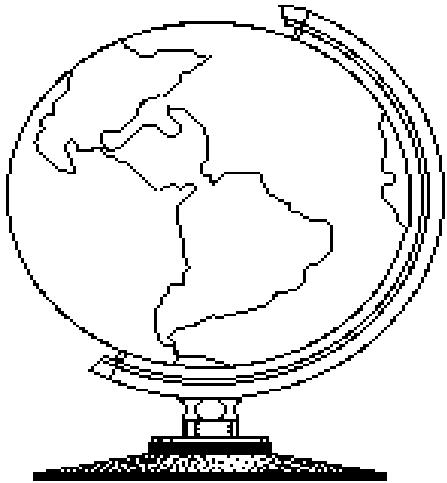

MONDO

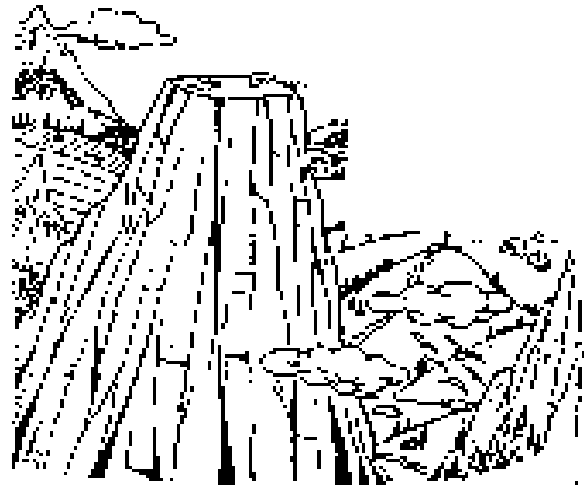

MONTAGNA

TERRA

MONTE

MEZZO

### I SINONIMI

Far associare ogni termine con il proprio sinonimo.

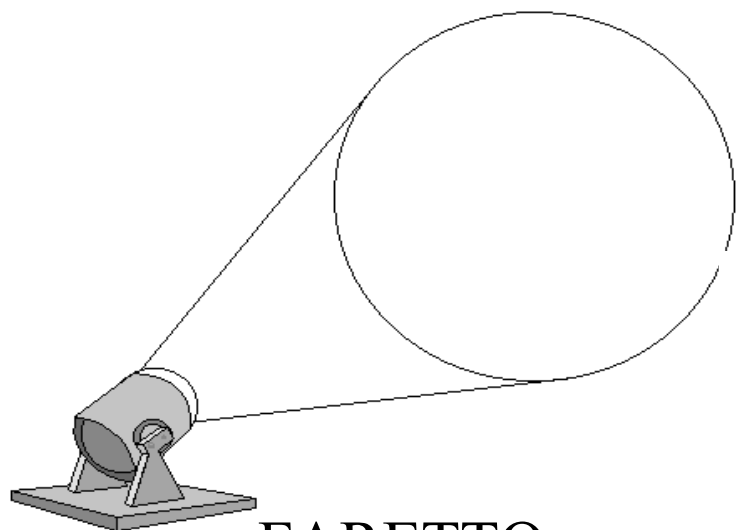

FARETTO

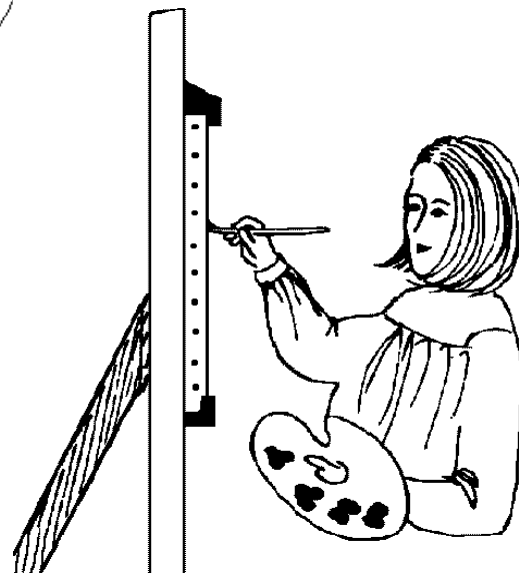

DIPINGERE



LAVARE

DECORARE

LAMPADA

PULIRE

### I SINONIMI

Far associare ogni termine con il proprio sinonimo.

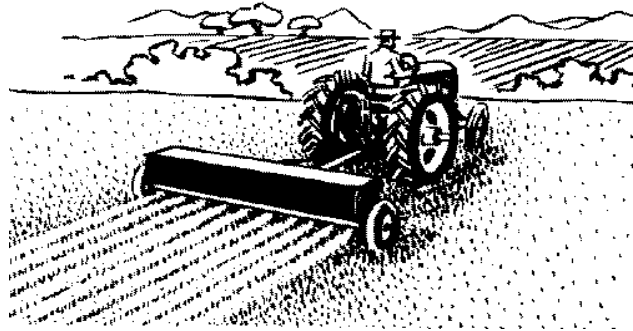

VEICOLO



BRUCO

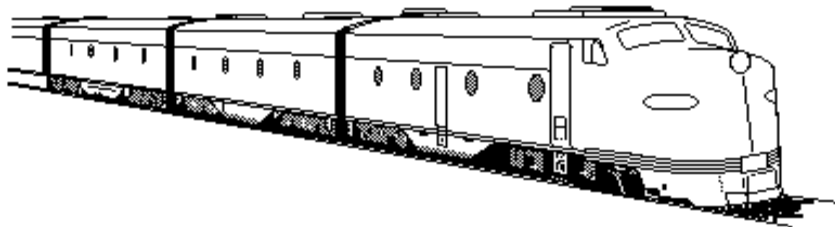

VELOCE

RAPIDO

MEZZO

VERME

I SINONIMI

Far associare ogni termine con il proprio sinonimo.



CONTADINO



CONTENITORE



PRANZO

CAMPAGNOLO

CONVIVIO

BARATTOLO

I SINONIMI

Far associare ogni termine con il proprio sinonimo.

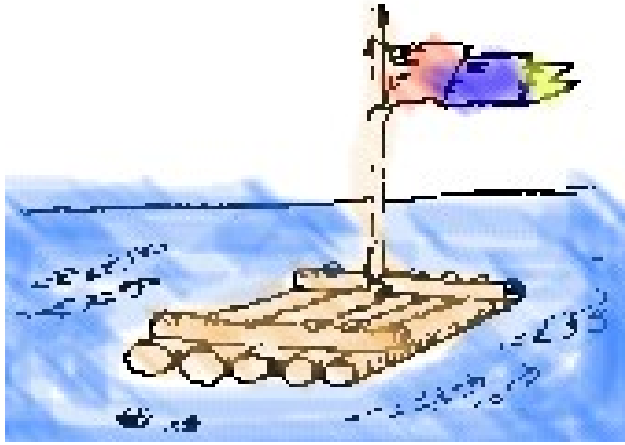

ZATTERA

CHIATTA

DOLCIFICANTE

MINESTRA



ZUCCHERO



ZUPPA

I SINONIMI

Far associare ogni termine con il proprio sinonimo.





BAGAGLIO

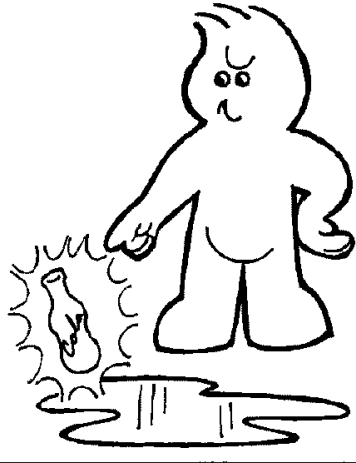

BAGNARE

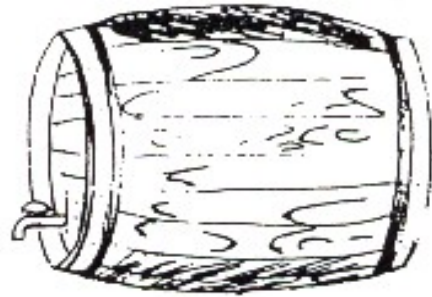

BARILE

VALIGIA

ANNAFFIARE

BOTTE

I SINONIMI

Far associare ogni termine con il proprio sinonimo.



BORSA

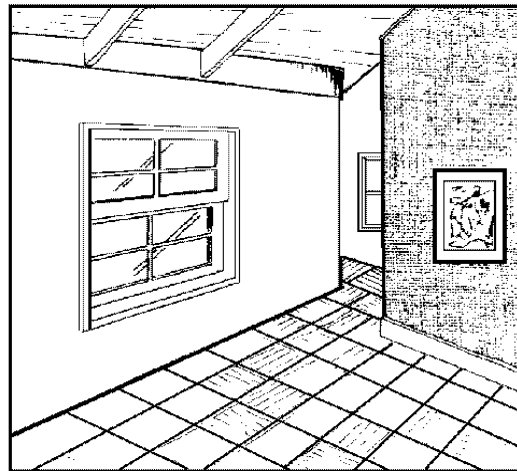

SALA

STANZA

SACCA

ANFORA



VASO

### I SINONIMI

Far associare ogni termine con il proprio sinonimo.

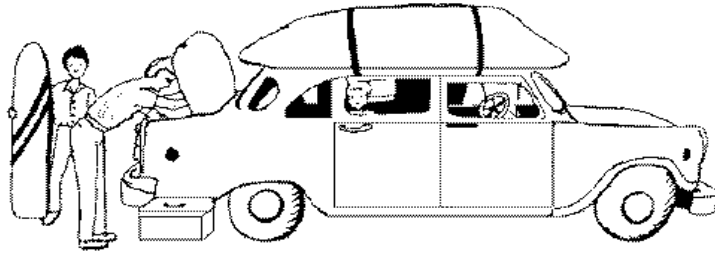

VIAGGIO

DECOLLARE

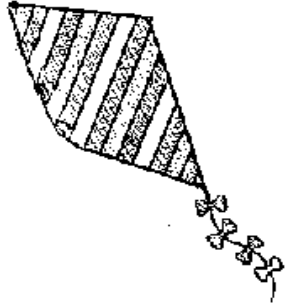

VOLARE

GITA



VENTO

SOFFIO

I SINONIMI

Far associare ogni termine con il proprio sinonimo.



COPERTA



LUCIDATURA

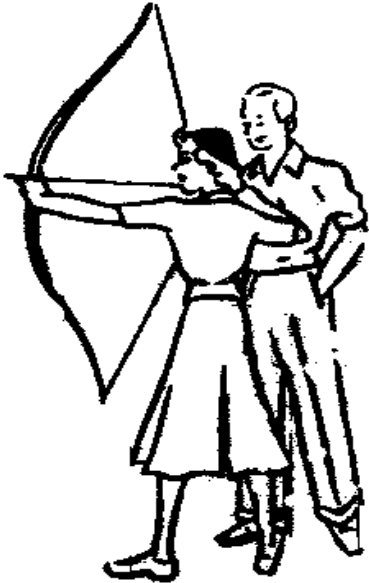

ABILE

LUSTRATURA

TRAPUNTA

CAPACE

I SINONIMI

Far associare ogni termine con il proprio sinonimo.



BUFERA



PAGLIACCIO



BURBERO

BUFFONE

SCORBUTICO

TEMPESTA

I SINONIMI

Far associare ogni termine con il proprio sinonimo.

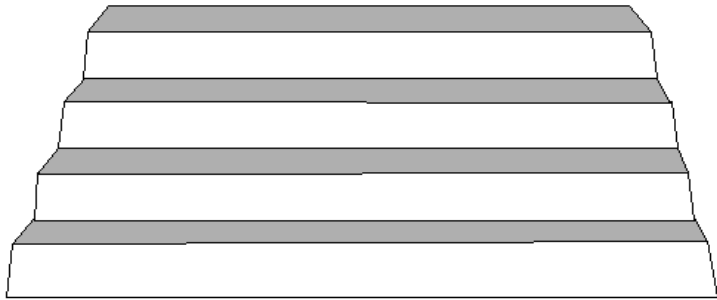

RAMPA



SALUTE



SALTARE

SALITA

BALZARE

BENESSERE

I SINONIMI

Far associare ogni termine con il proprio sinonimo.



COMODO



COMPRARE

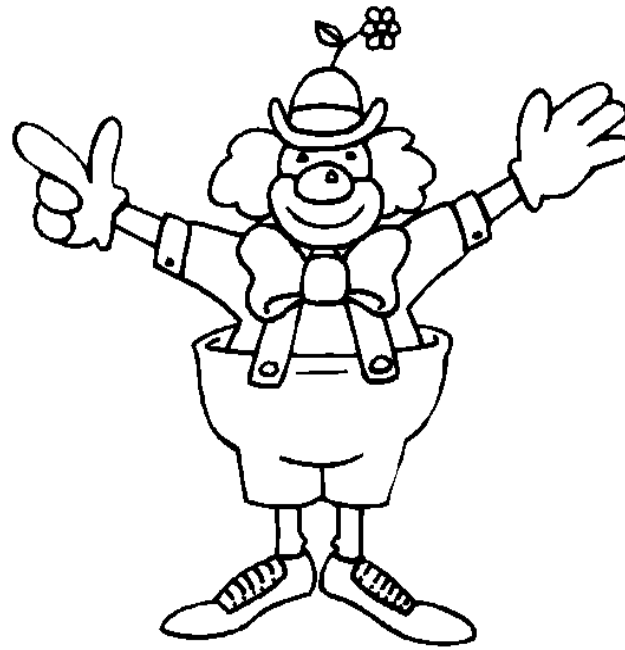

COMICO

RIPOSANTE

ACQUISTARE

BUFFO

I SINONIMI

Far associare ogni termine con il proprio sinonimo.



URLO

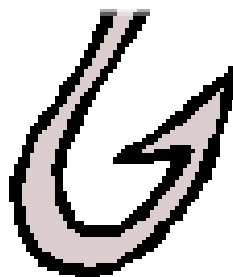

UNCINO



UTENSILE

GRIDO

ATTREZZO

GANCIO

### I SINONIMI

Far associare ogni termine con il proprio sinonimo.





VENDITORE



VIGORE

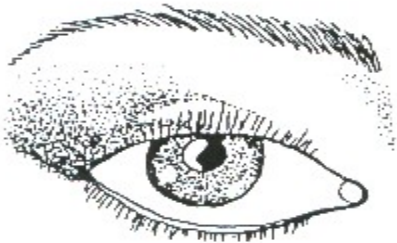

VISTA

PERCEZIONE

NEGOZIANTE

CORAGGIO

I SINONIMI

Far associare ogni termine con il proprio sinonimo.



SCOLARO



SOLE

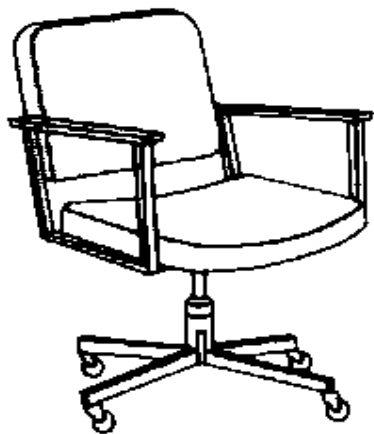

SEDIA

ALUNNO

POLTRONA

LUCE

### I SINONIMI

Far associare ogni termine con il proprio sinonimo.



STADIO



GRUPPO



SACCA

CAMPO

TASCA

COMPLESSO

### I SINONIMI

Far associare ogni termine con il proprio sinonimo.



GINNASTICA

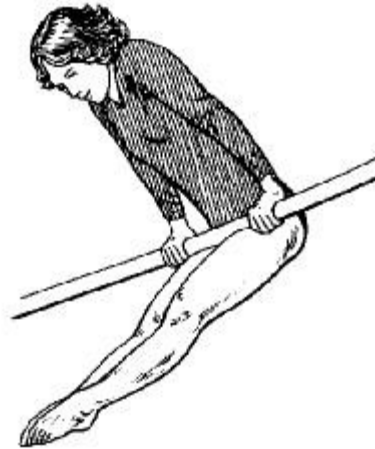

RAGAZZO

GIOVANE

SPORT

GOLFO



BAIA

### I SINONIMI

Far associare ogni termine con il proprio sinonimo.

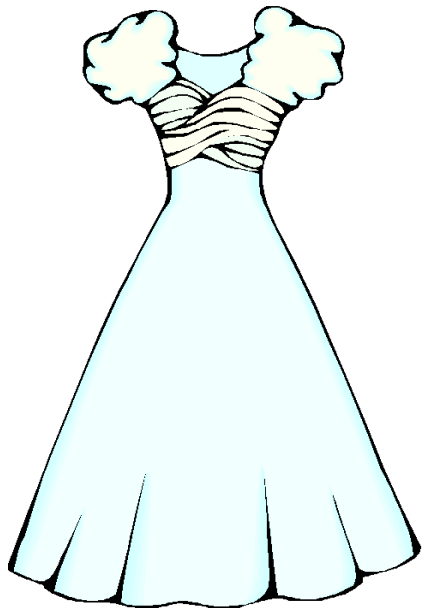

VESTITO



VISO

AUTOMOBILE

FACCIA

ABITO

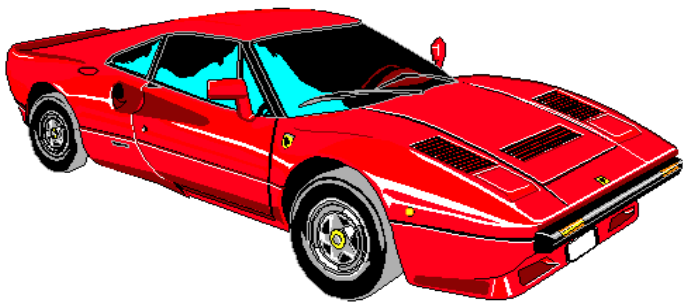

VETTURA

I SINONIMI

Far associare ogni termine con il proprio sinonimo.

TESTO



COMPETIZIONE



EBOLLIZIONE

EDIZIONE

BOLLITURA

RIVALITÀ

I SINONIMI

Far associare ogni termine con il proprio sinonimo.

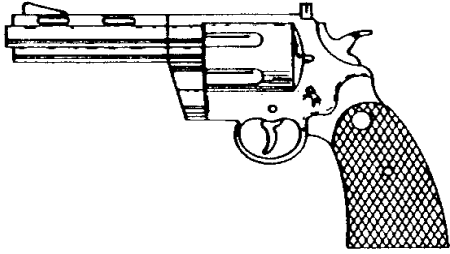

RIVOLTELLA



FULMINE



SACRO

DIVINO

SAETTA

PISTOLA

I SINONIMI

Far associare ogni termine con il proprio sinonimo.



BARRIERA

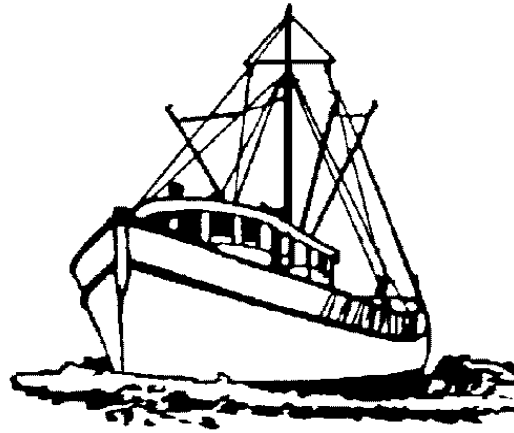

NAVE

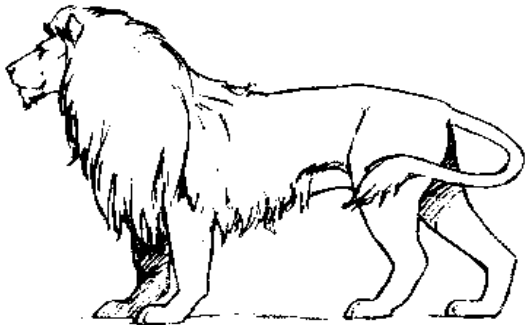

BELVA

BASTIMENTO

BESTIA

SBARRAMENTO

I SINONIMI

Far associare ogni termine con il proprio sinonimo.



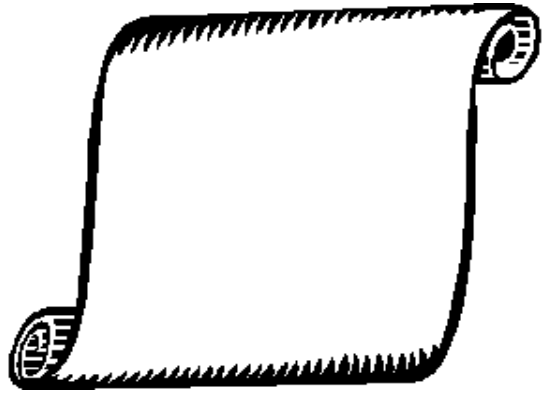

FOGLIO



PAIO

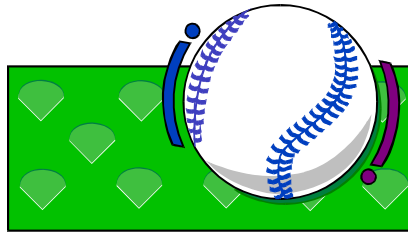

PALLA

COPPIA

PAGINA

SFERA

I SINONIMI

Far associare ogni termine con il proprio sinonimo.

BACCHETTE



BACILE

ATLETICO

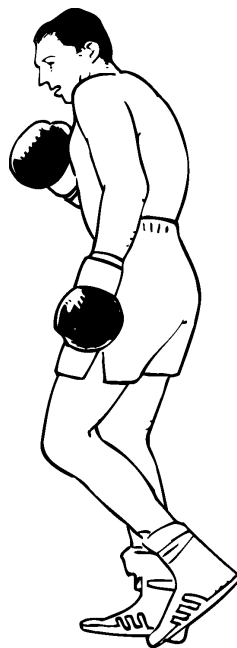

ASTINE

SPORTIVO

VASCHETTA

I SINONIMI

Far associare ogni termine con il proprio sinonimo.



NOTTE



MATRIMONIO



NUVOLA

NOZZE

BUIO

NUBE

I SINONIMI

Far associare ogni termine con il proprio sinonimo.

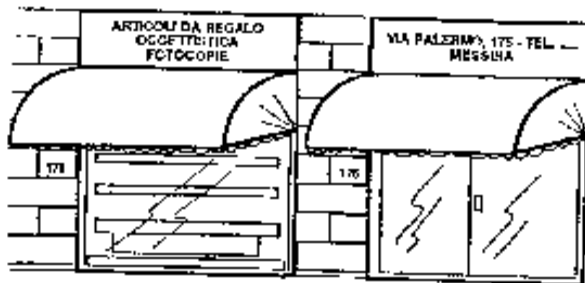

NEGOZIO

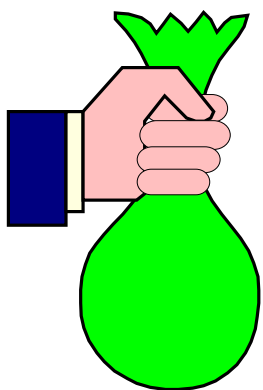

BOTTINO

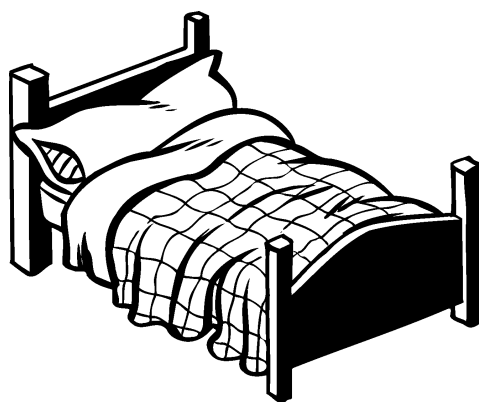

LETTINO

BRANDA

MALLOPPO

BOTTEGA

I SINONIMI

Far associare ogni termine con il proprio sinonimo.

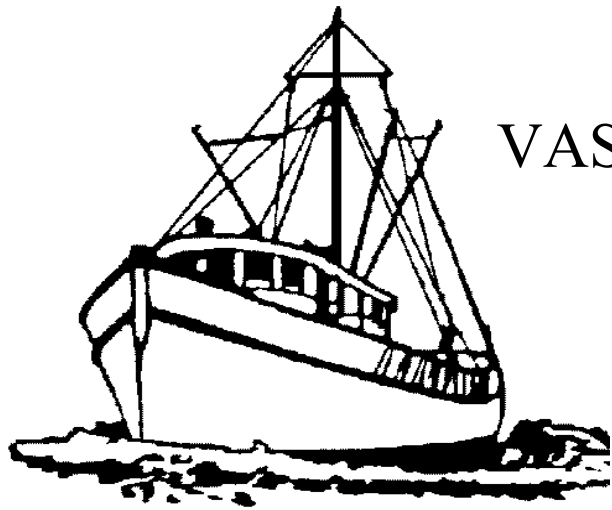

VASCELLO



COPERTA



VENDITA

VELO

COMMERCIO

BARCA

I SINONIMI

Far associare ogni termine con il proprio sinonimo.



DISEGNO

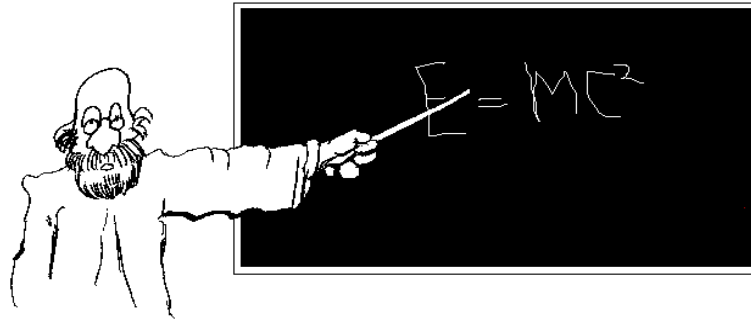

DOCENTE

INSEGNANTE

DISPENSA

CREDENZA



SCHIZZO

I SINONIMI

Far associare ogni termine con il proprio sinonimo.



CANTARE



CASTIGO

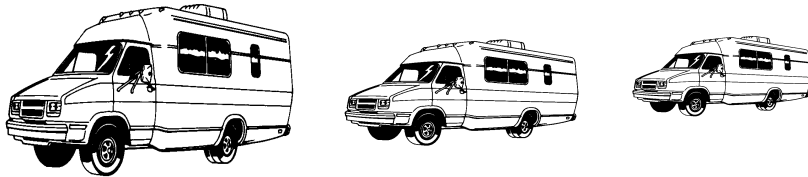

CAROVANA

COMITIVA

PUNIZIONE

INTONARE

I SINONIMI

Far associare ogni termine con il proprio sinonimo.



FIRMA



SACERDOTE

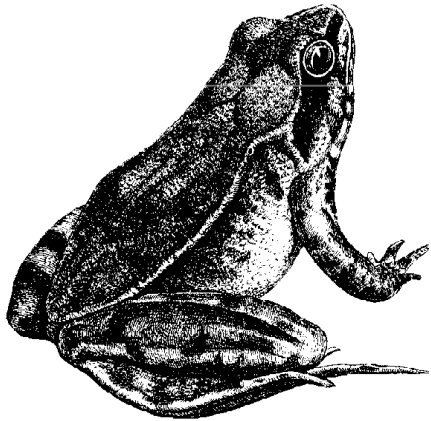

ROSPO

RANOCCHIO

SOTTOSCRIZIONE

PRETE

I SINONIMI

Far associare ogni termine con il proprio sinonimo.





APPETITO

CELEBRE



PARENTI

FAME

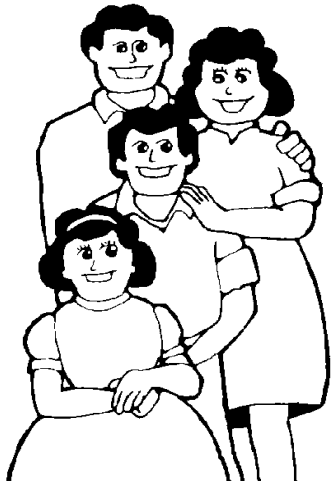

FAMIGLIA

FAMOSO

I SINONIMI

Far associare ogni termine con il proprio sinonimo.

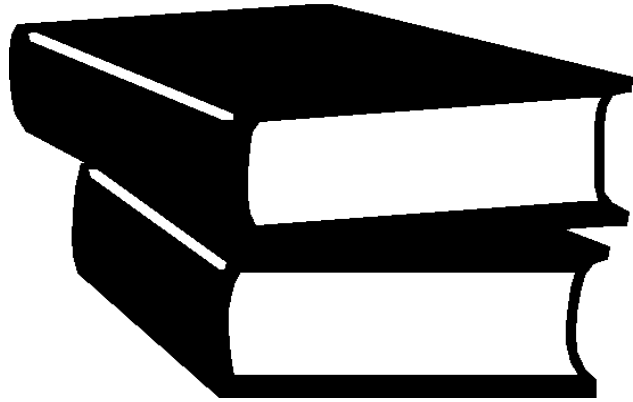

COPIA

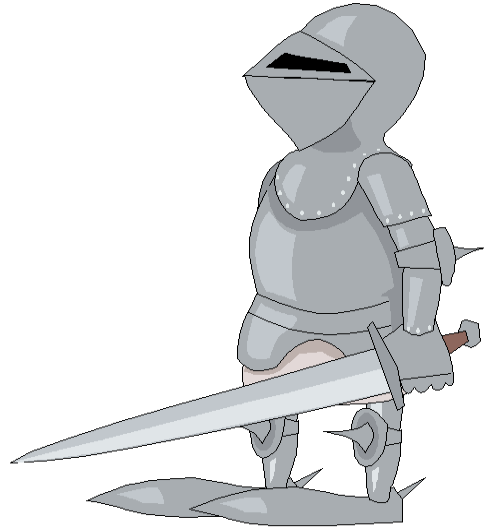

CORAZZA

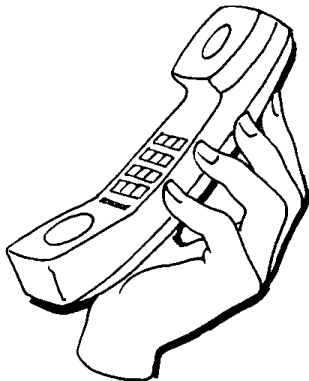

CORNETTA

DUPPLICATO

MICROFONO

PROTEZIONE

### I SINONIMI

Far associare ogni termine con il proprio sinonimo.



FATICA



VACANZA



FESTA

FERIE

SFACCHINATA

CELEBRAZIONE

I SINONIMI

Far associare ogni termine con il proprio sinonimo.

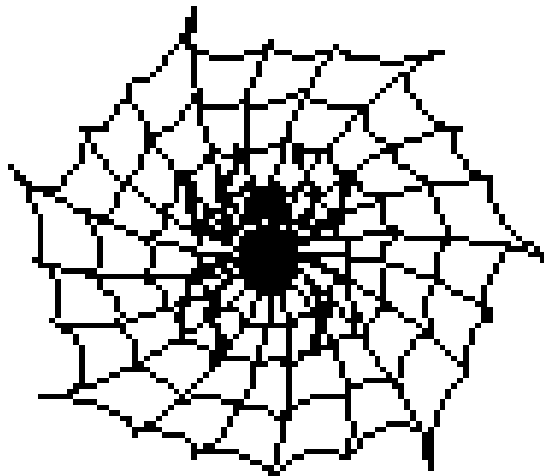

RAGNATELA



REGALO

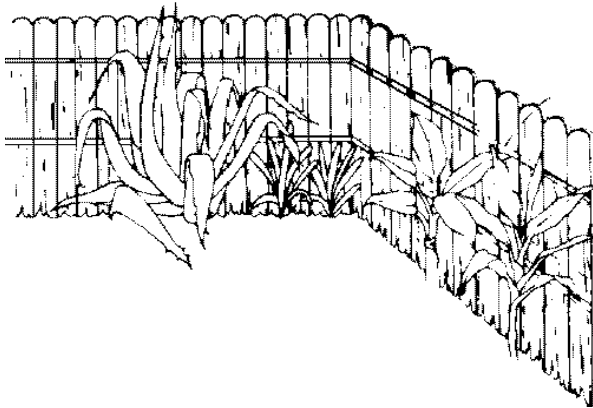

RECINTO

DONO

RETE

STECCATO

I SINONIMI

Far associare ogni termine con il proprio sinonimo.

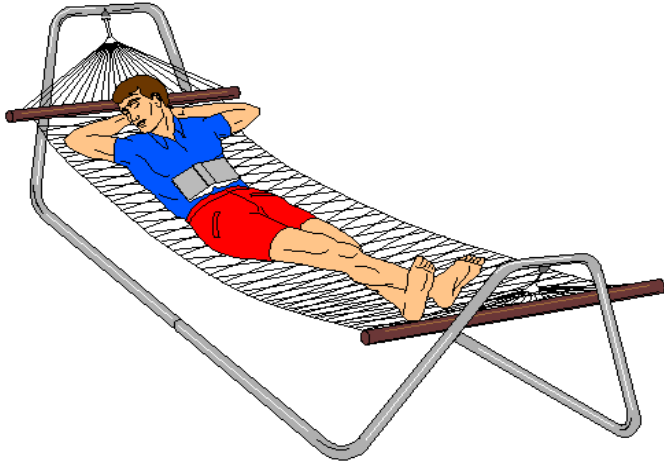

RIPOSO

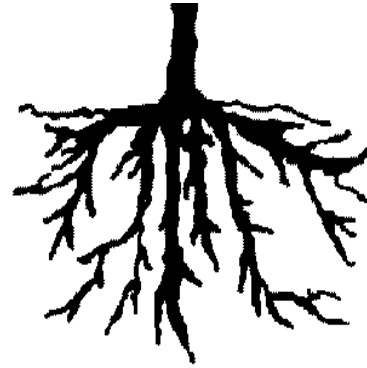

RADICE

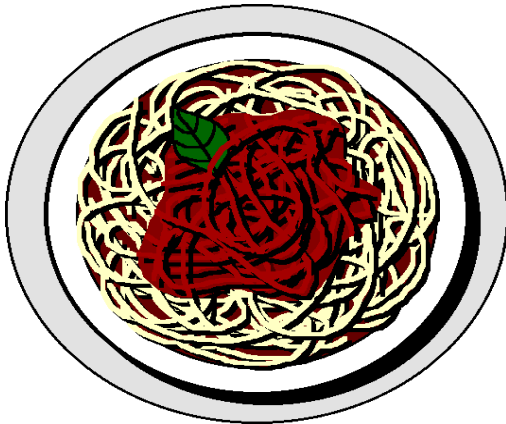

SALSA

BULBO

QUIETE

RAGU'

I SINONIMI

Far associare ogni termine con il proprio sinonimo.

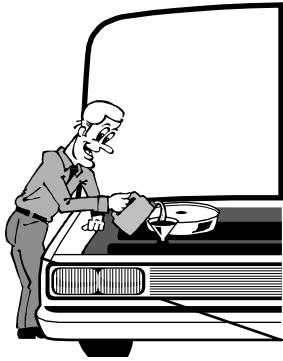

MACCHINISTA

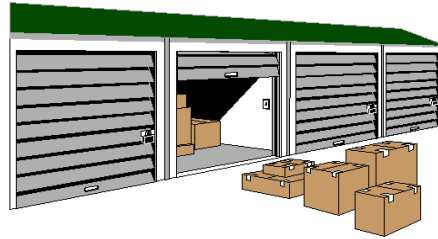

MAGAZZINO



MALANDATO

DEPOSITO

AUTISTA

MALCONCIO

I SINONIMI

Far associare ogni termine con il proprio sinonimo.



IDEA



INCERTO



ILLUSTRE

PENSIERO

DUBBIOSO

FAMOSO

I SINONIMI

Far associare ogni termine con il proprio sinonimo.

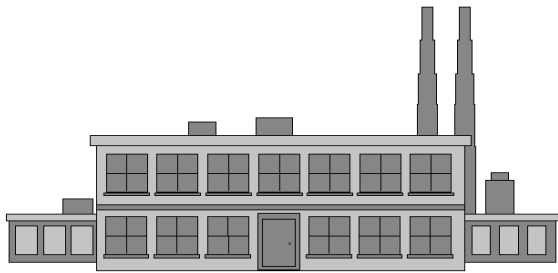

FABBRICA



FARE



FANCIULLEZZA

INFANZIA

REALIZZARE

STABILIMENTO

### I SINONIMI

Far associare ogni termine con il proprio sinonimo.



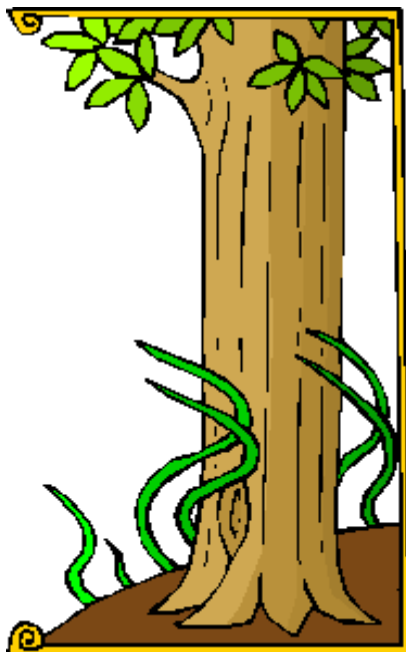

TRONCO



LOCALE



LUCE

TIPICO

CHIARORE

LEGNO

I SINONIMI

Far associare ogni termine con il proprio sinonimo.



PRENDERE



PILLOLE

COMPRESSA

ESPERTO

AFFERRARE



CONSULENTE

I SINONIMI

Far associare ogni termine con il proprio sinonimo.



RITO



RIVA



RISSA

CERIMONIA

SPIAGGIA

LITIGIO

I SINONIMI

Far associare ogni termine con il proprio sinonimo.



TRAINARE

TIRARE

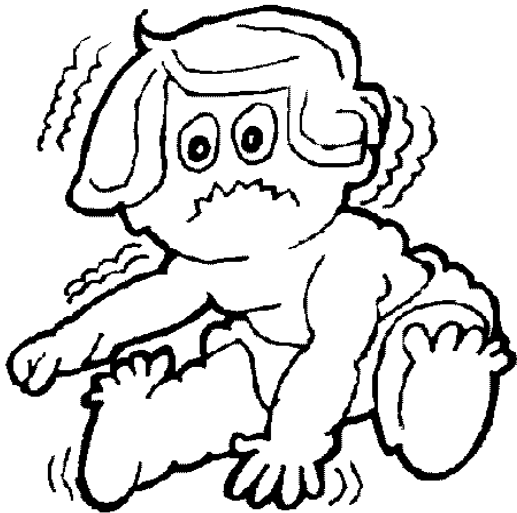

TREMARE



TRIBU'

VIBRARE

GENTE

I SINONIMI

Far associare ogni termine con il proprio sinonimo.



TRUFFA



SALUTO



PENSIERO

OMAGGIO

RAGIONAMENTO

RAGGIRO

### I SINONIMI

Far associare ogni termine con il proprio sinonimo.

## **LE CATEGORIE**

Gli oggetti, le persone e gli animali possono essere raggruppati in categorie logiche, tenendo conto delle loro caratteristiche o condizioni fisiche, dell'uso o della funzione che essi esercitano.

Le categorie sono alla base della cultura umana e quindi importante una loro corretta conoscenza.

### **UTILIZZAZIONE**

#### 1<sup>a</sup> Fase

Per utilizzare tali schede basta leggere o far leggere la categoria richiesta chiedendo di associarla alle immagini che la rappresentano.

#### 2<sup>a</sup> Fase

In un secondo momento è possibile effettuare l'esercizio partendo dalle immagini e chiedendo al bambino a quale categoria appartengono gli oggetti rappresentati.

### **ETA' DI RIFERIMENTO**

Cinque anni nello sviluppo logico.

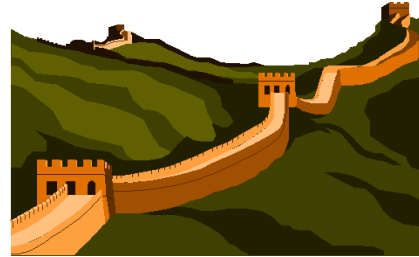

I MONUMENTI  
CINESI



I MONUMENTI  
AMERICANI

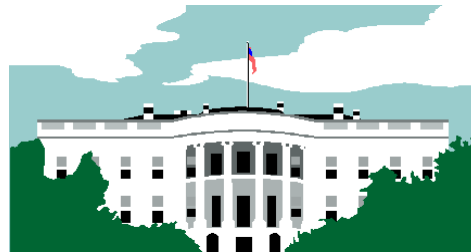

I MONUMENTI  
INGLESI

## LE CATEGORIE

Far associare, ogni gruppo di immagini, alla categoria corrispondente.

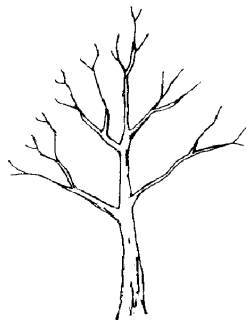
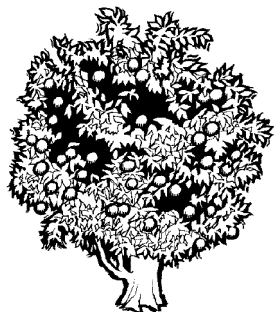

LE ERBE  
AROMATICHE

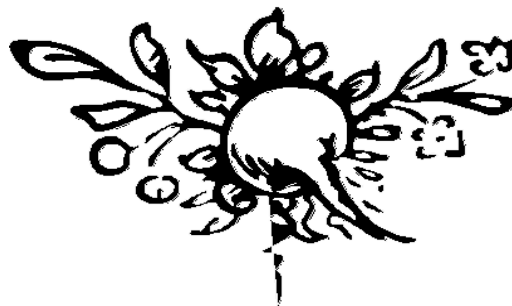
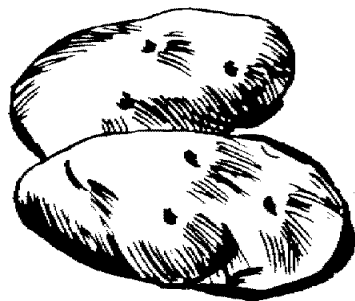

GLI ALBERI

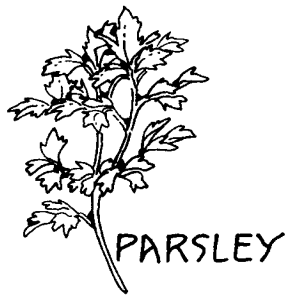

PARSLEY

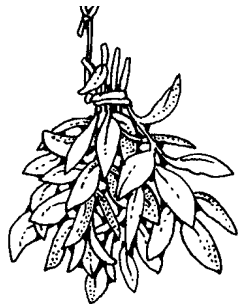

MINT

I BULBI ED  
I RIZOMI

### LE CATEGORIE

Far associare, ogni gruppo di immagini, alla categoria corrispondente.





I RODITORI

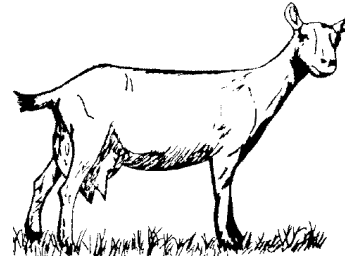
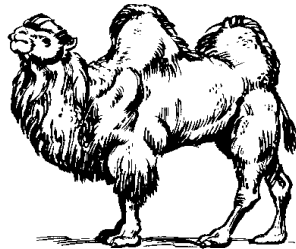
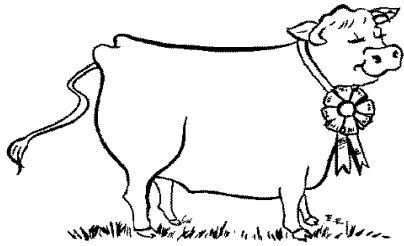

I CARNIVORI

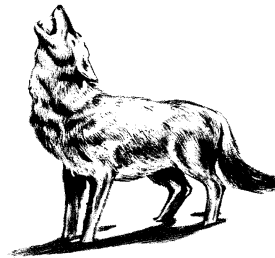
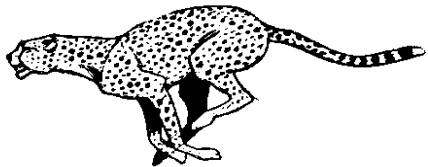

GLI ERBIVORI

## LE CATEGORIE

Far associare, ogni gruppo di immagini, alla categoria corrispondente.

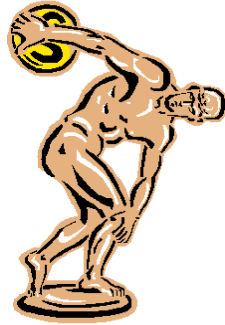
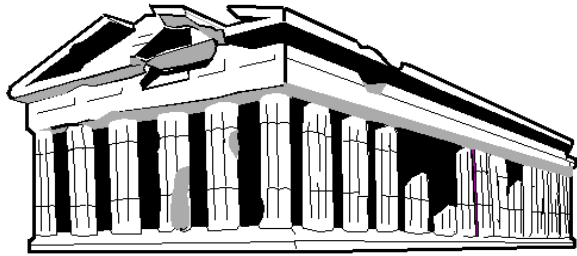

I MONUMENTI  
EGIZI

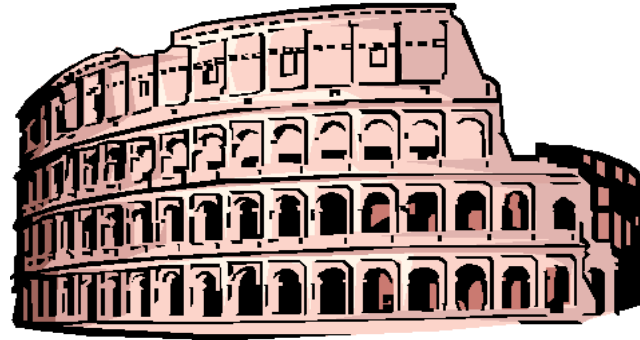
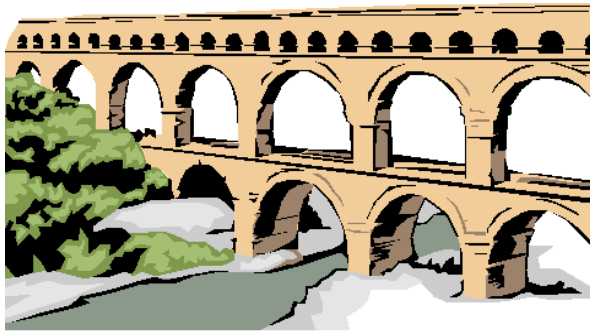

I MONUMENTI  
GRECI

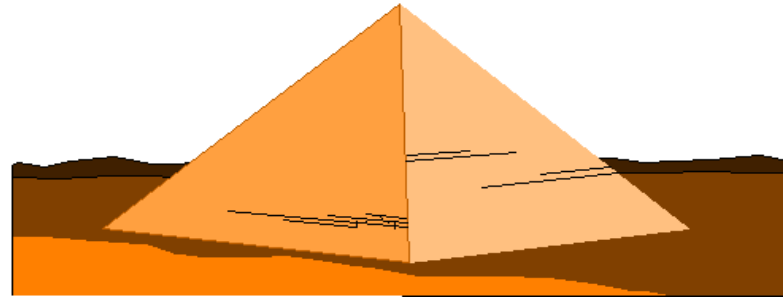

I MONUMENTI  
ROMANI

## LE CATEGORIE

Far associare, ogni gruppo di immagini, alla categoria corrispondente.

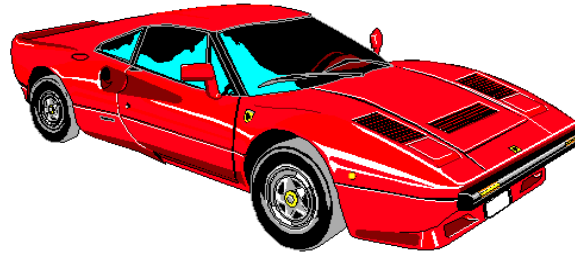
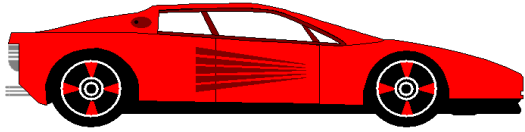

LE AUTO DA  
CORSA

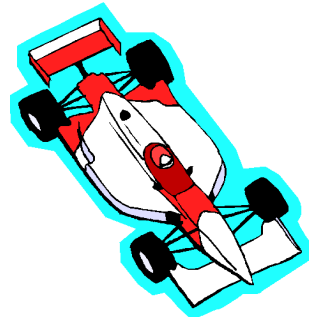

LE BERLINE

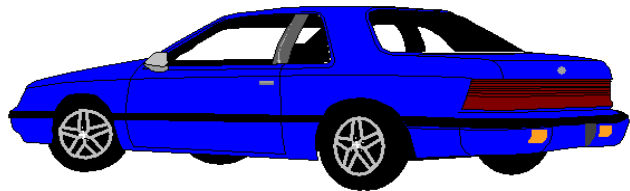

LE AUTO  
SPORTIVE

## LE CATEGORIE

Far associare, ogni gruppo di immagini, alla categoria corrispondente.

**A E O**

LE CONSONANTI

**C T S**

LE VOCALI

**BA LA DO**

LE SILLABE

LE CATEGORIE

Far associare, ogni gruppo di immagini, alla categoria corrispondente.

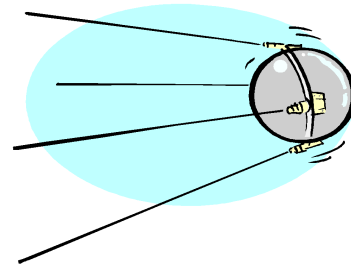
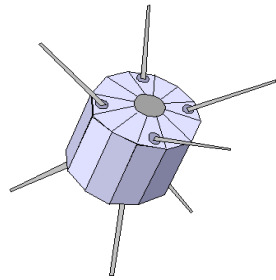
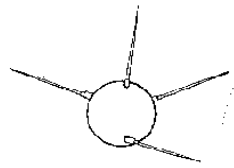

LE ASTRONAVI

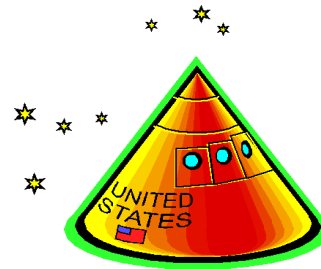
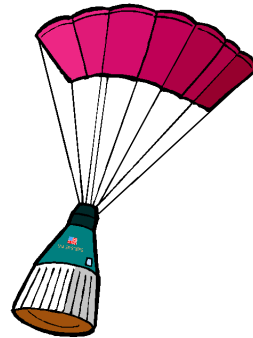
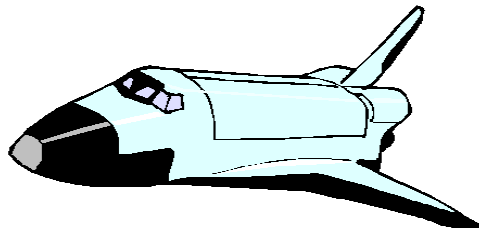

I SATELLITI

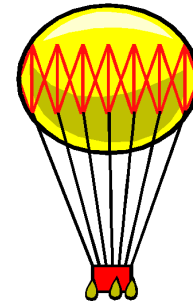
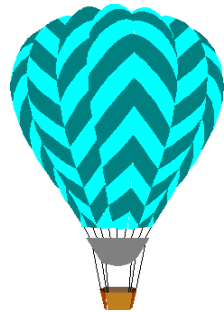

LE MONGOLFIERE

## LE CATEGORIE

Far associare, ogni gruppo di immagini, alla categoria corrispondente.

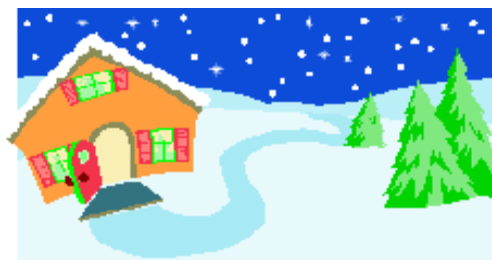

PAESAGGI  
ESTIVI

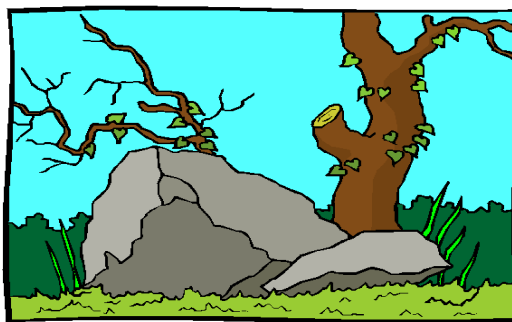

PAESAGGI  
AUTUNNALI

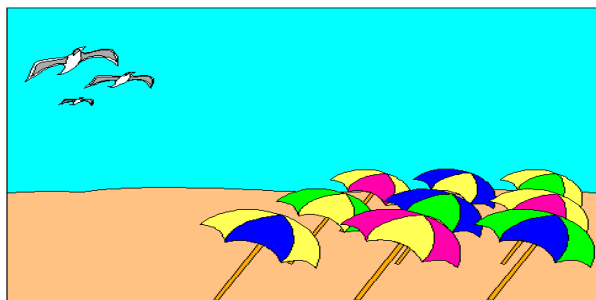

PAESAGGI  
INVERNALI

### LE CATEGORIE

Far associare, ogni gruppo di immagini, alla categoria corrispondente.

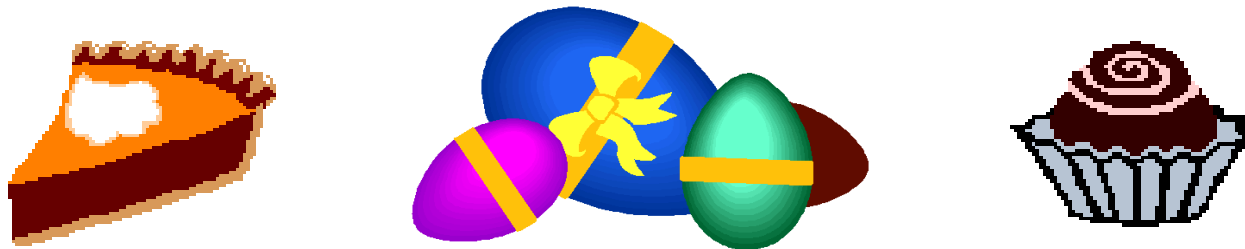

I DOLCI ALLA  
FRUTTA



I DOLCI AL  
CIOCCOLATO

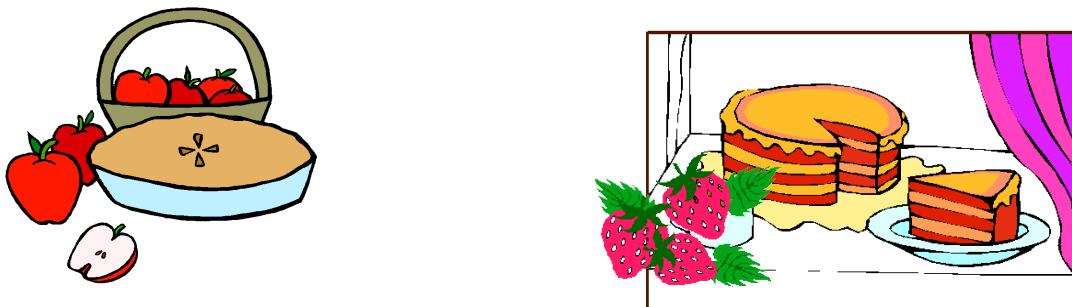

I DOLCI ALLA  
PANNA

## LE CATEGORIE

Far associare, ogni gruppo di immagini, alla categoria corrispondente.

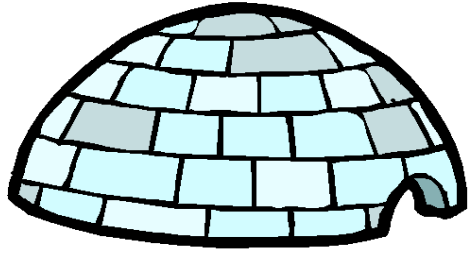

I CASTELLI

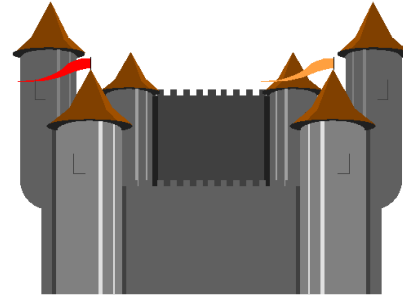

LE VILLE

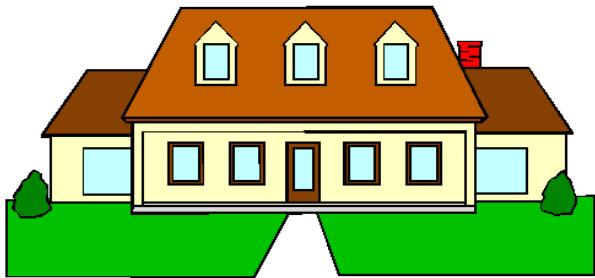

GLI IGLU'

## LE CATEGORIE

Far associare, ogni gruppo di immagini, alla categoria corrispondente.



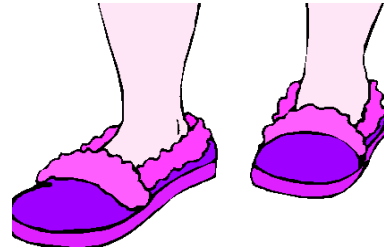

LE CALZATURE  
PER LA CITTA'



LE CALZATURE  
PER LA CASA

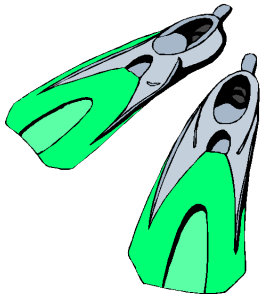

LE CALZATURE  
PER IL TEMPO  
LIBERO

### LE CATEGORIE

Far associare, ogni gruppo di immagini, alla categoria corrispondente.

## **RAGGRUPPAMENTI LOGICI**

Collegare figure geometriche, animali, vegetali, effettuando raggruppamenti, è una delle funzioni più importanti sia per lo sviluppo logico che per l'arricchimento culturale.

Per semplificare al massimo questo tipo di attività, in ogni scheda sono presenti solo sei elementi da collegare, denominandoli, in modo tale da formare due gruppi di tre oggetti.

Tali categorie dovranno essere effettuate seguendo le indicazioni presenti in ogni scheda.

## **UTILIZZAZIONE**

Il bambino oltre che indicare gli elementi richiesti denominerà i singoli oggetti, indicando le loro caratteristiche peculiari.

## **ETÀ MENTALE DI RIFERIMENTO**

Sette anni di età cronologica o mentale.

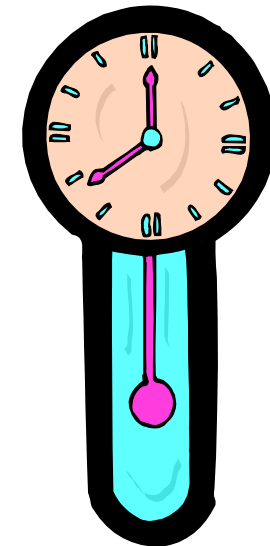
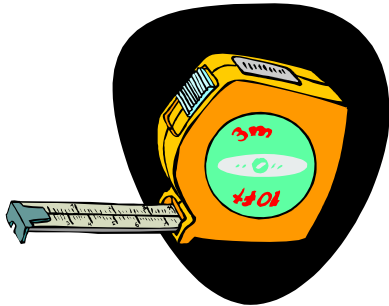
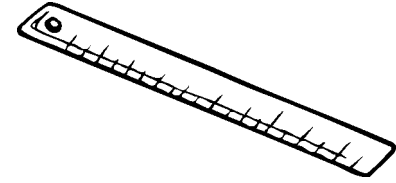
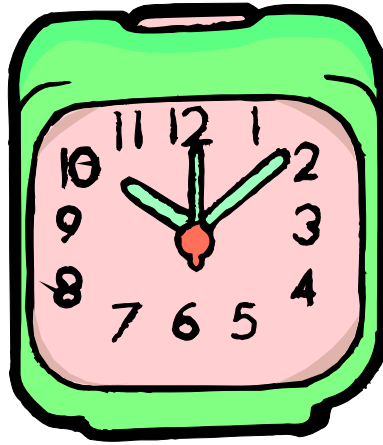

### RAGGRUPPAMENTI LOGICI

Far raggruppare tutti gli strumenti per **misurare il tempo** e quelli per **misurare le distanze**.

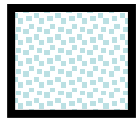
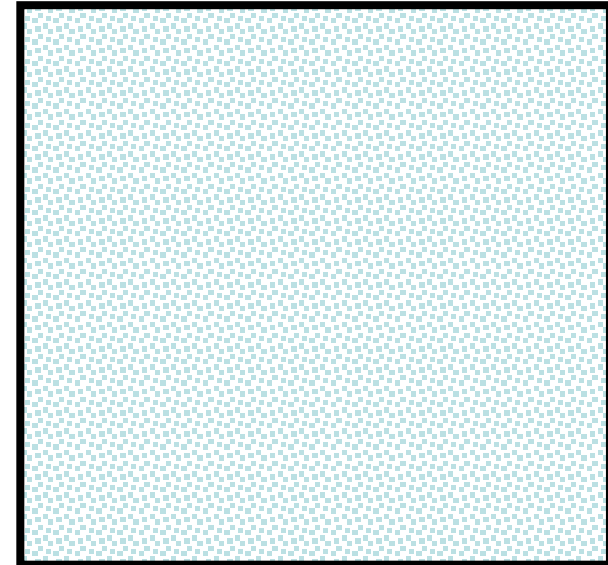
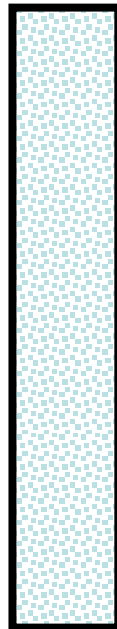
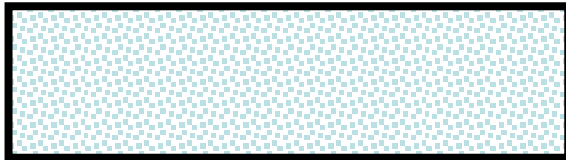
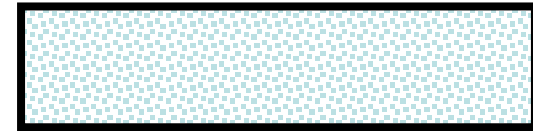
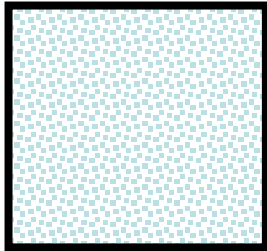

## RAGGRUPPAMENTI LOGICI

Far indicare tutti i **quadrati** e poi tutti i **rettangoli**.



## RAGGRUPPAMENTI LOGICI

Far raggruppare tutti i particolari delle **piante**.

Far raggruppare tutti i particolari degli **animali**.

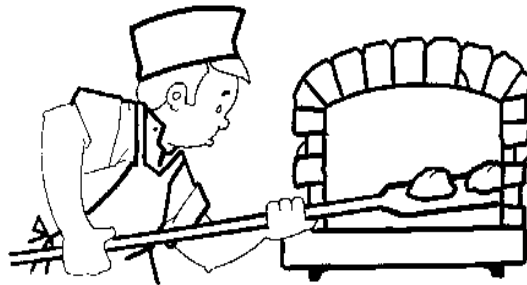
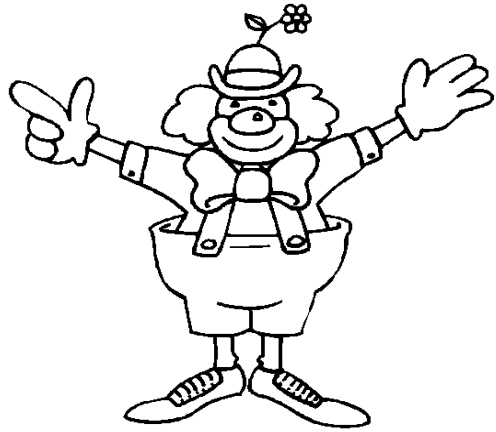

## RAGGRUPPAMENTI LOGICI

Far raggruppare tutte le **persone che lavorano.**

Far raggruppare tutte le **persone che non lavorano.**

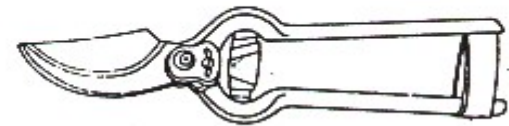
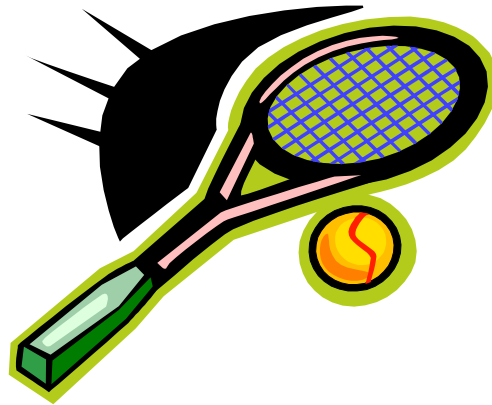
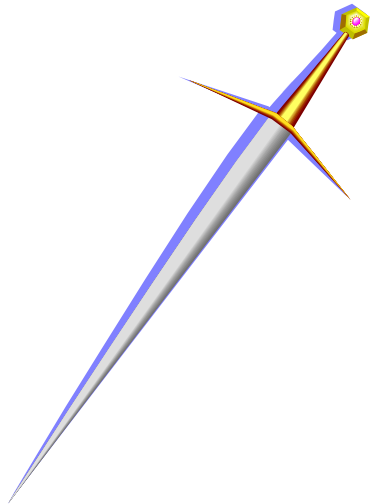
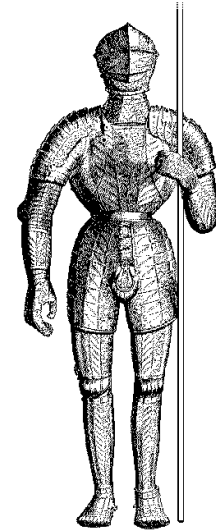
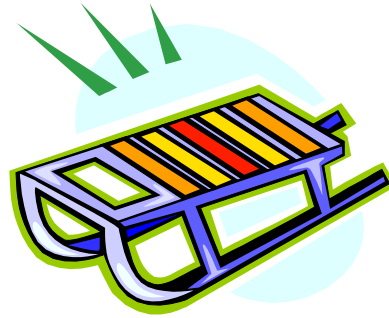
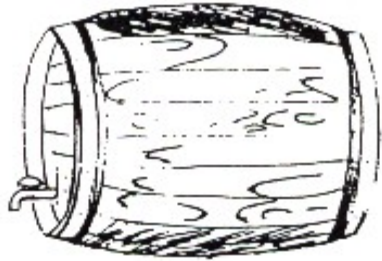

### RAGGRUPPAMENTI LOGICI

Far raggruppare tutti gli oggetti **fatti di ferro.**

Far raggruppare tutti gli oggetti **fatti di legno.**

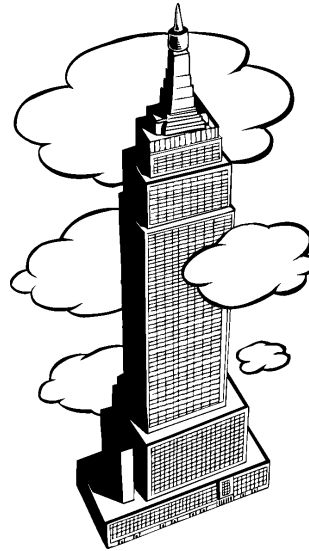
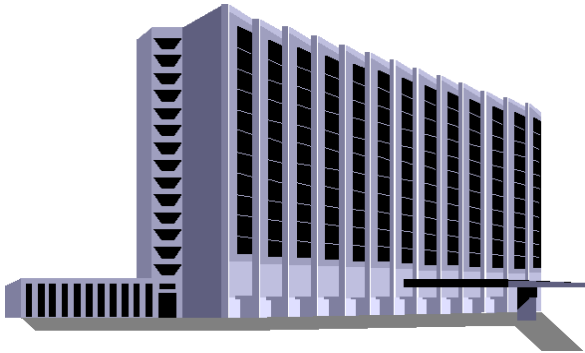
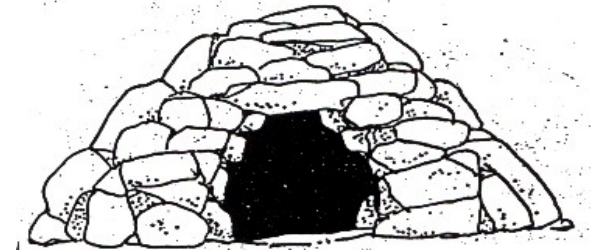

## RAGGRUPPAMENTI LOGICI

Far raggruppare tutte le **abitazioni antiche**.

Far raggruppare le **abitazioni moderne**.



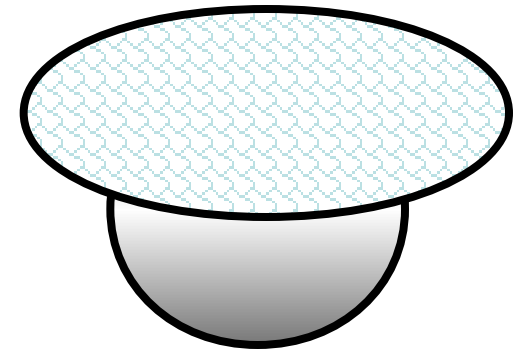
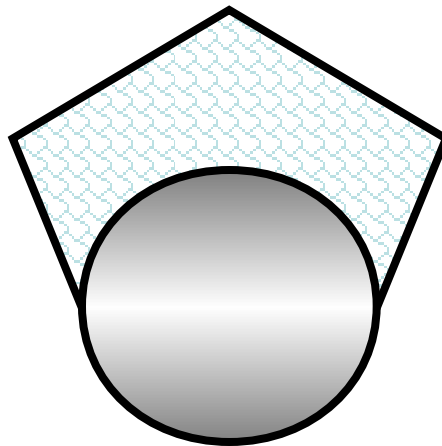
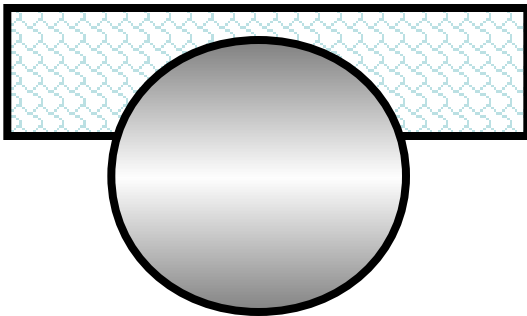
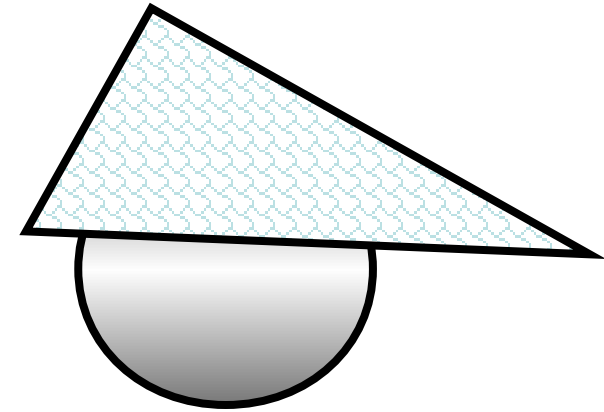
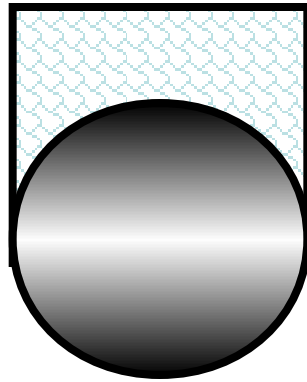
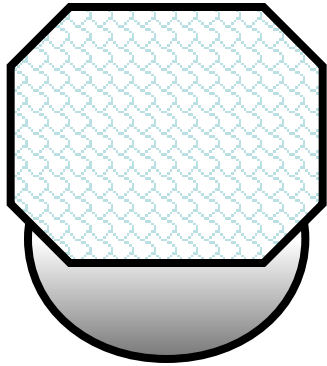

### RAGGRUPPAMENTI LOGICI

Far raggruppare tutti le figure che hanno il cerchio **davanti**.

Far raggruppare tutte le figure che hanno il cerchio **dietro**.

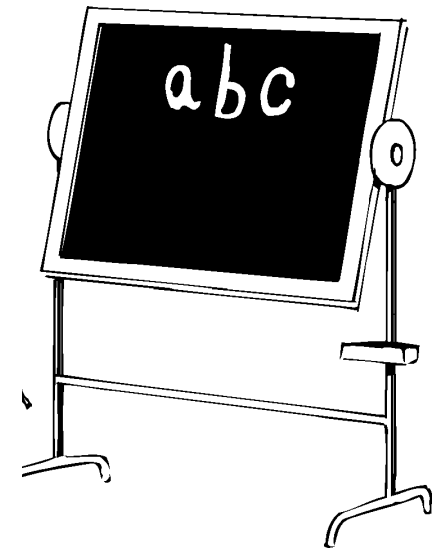
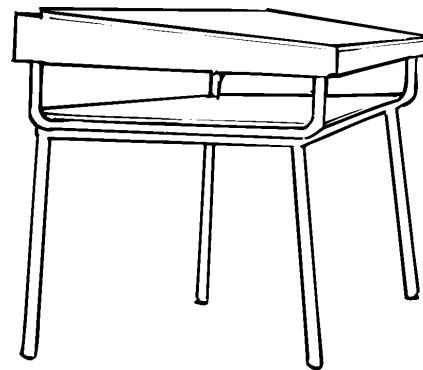
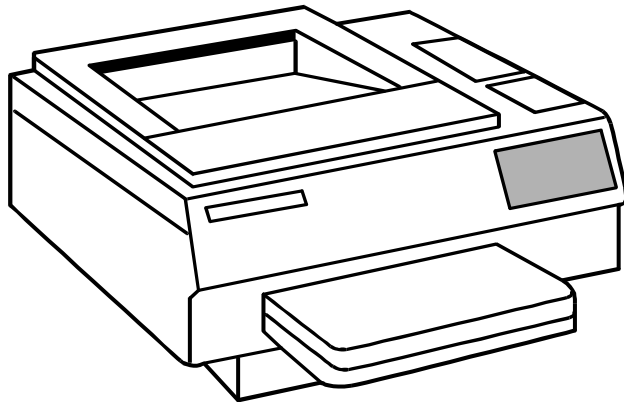
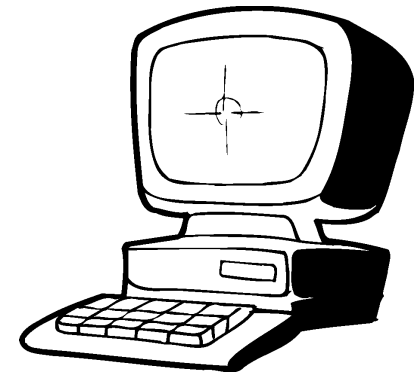
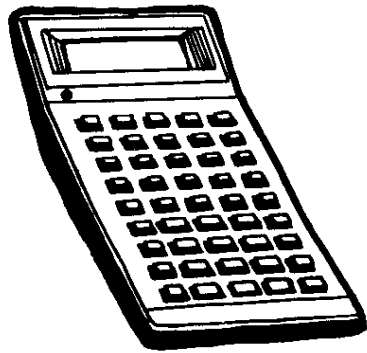

### RAGGRUPPAMENTI LOGICI

Far raggruppare tutti gli **oggetti per la scuola.**

Far raggruppare tutti gli **oggetti per l'ufficio.**

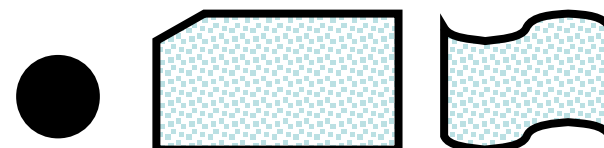
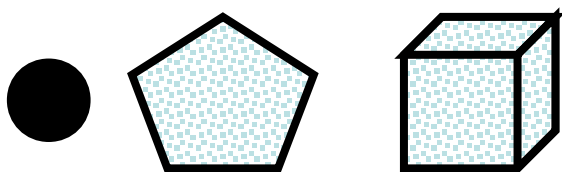
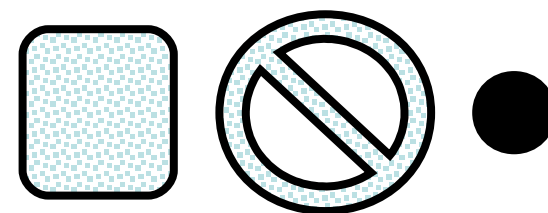
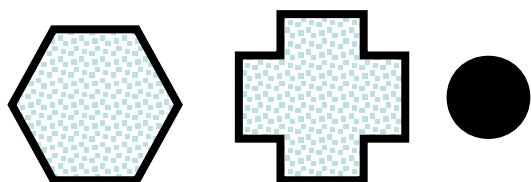
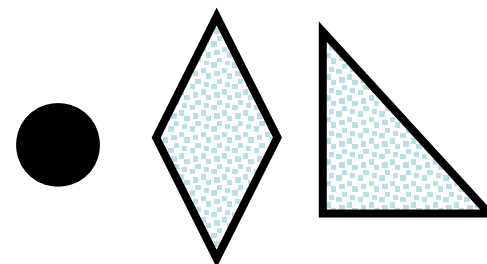

Far indicare le palline che stanno a **destra** delle figure geometriche.  
Far indicare le palline che stanno a **sinistra** delle figure geometriche.

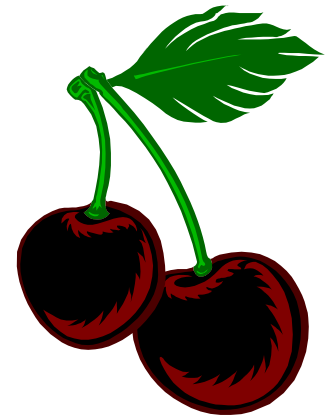
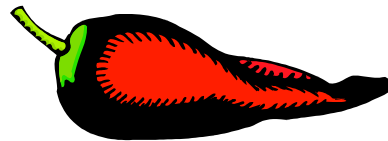
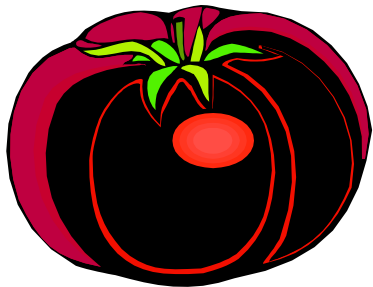
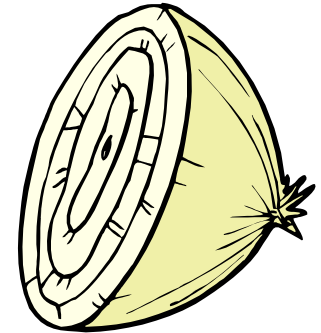
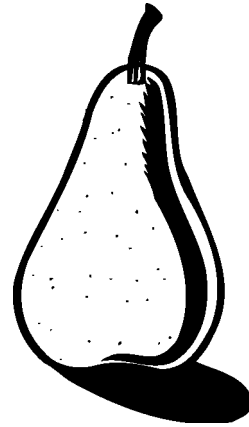
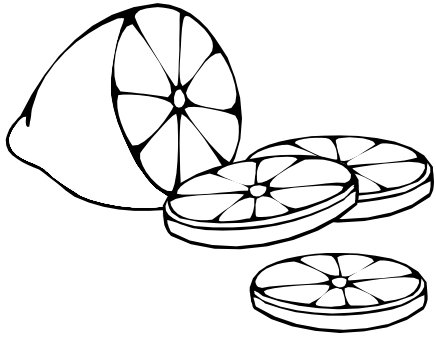

### RAGGRUPPAMENTI LOGICI

Far raggruppare tutti i **frutti**.

Far raggruppare tutti gli **ortaggi**.

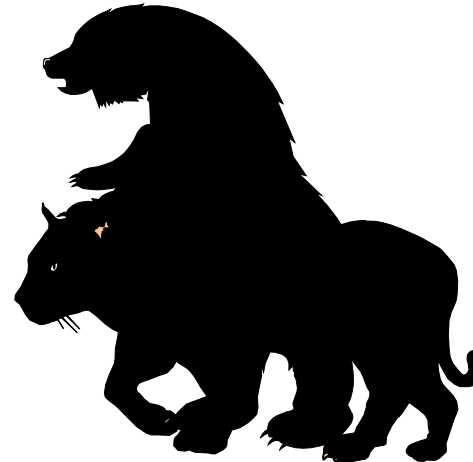
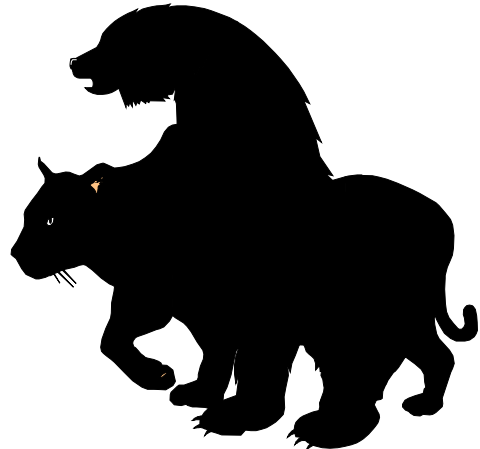
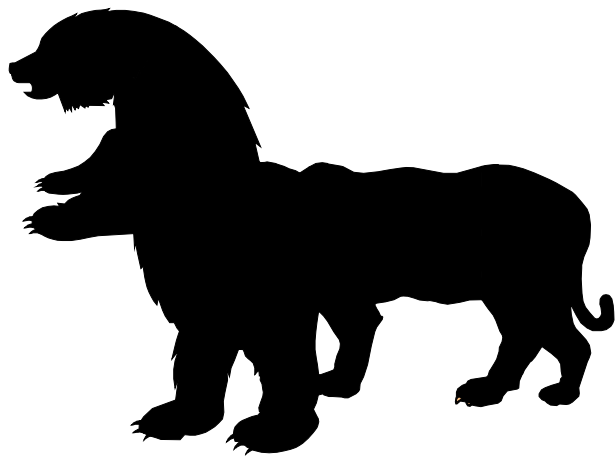

### RAGGRUPPAMENTI LOGICI

Far indicare tutte le immagini dove la tigre sta **dietro** l'orso.

Far indicare tutte le immagini dove la tigre sta **davanti** all'orso.

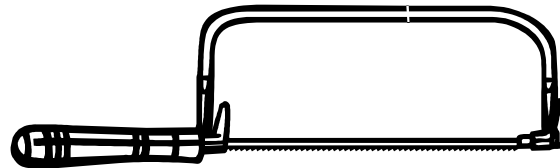
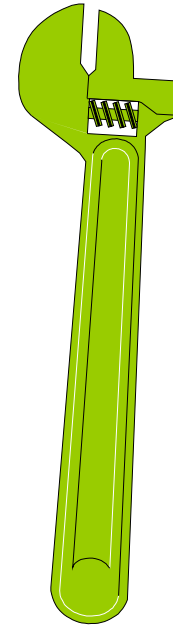
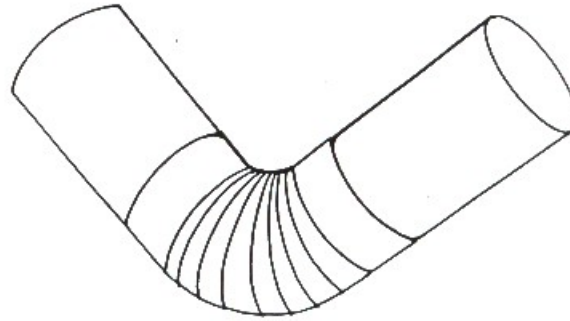

### RAGGRUPPAMENTI LOGICI

Far raggruppare tutti gli oggetti usati dal **contadino**.

Far raggruppare tutti gli strumenti usati dall'**idraulico**.

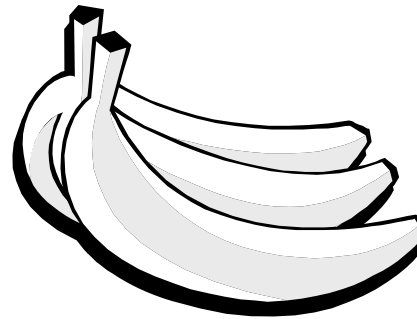
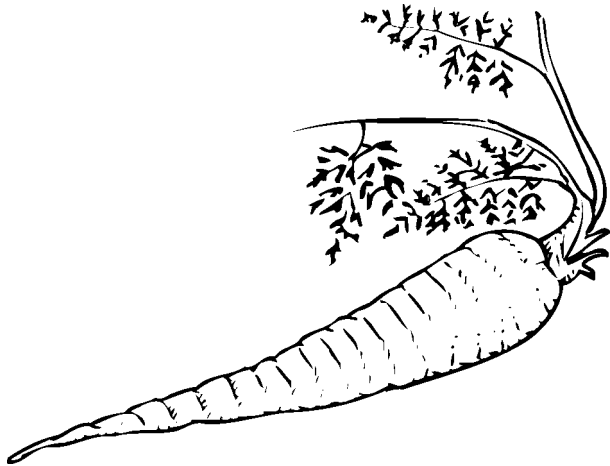
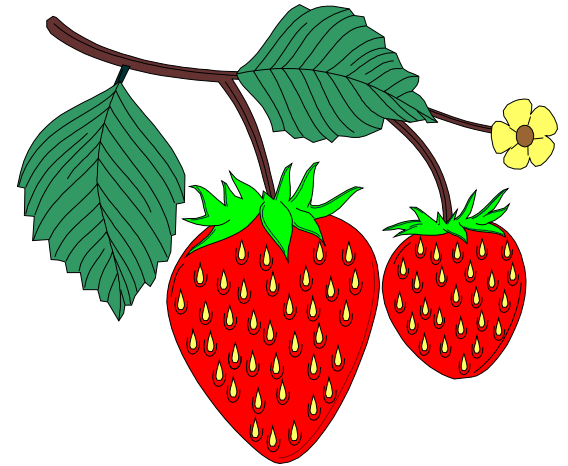
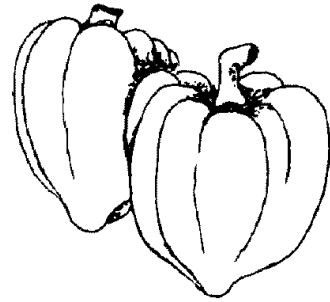
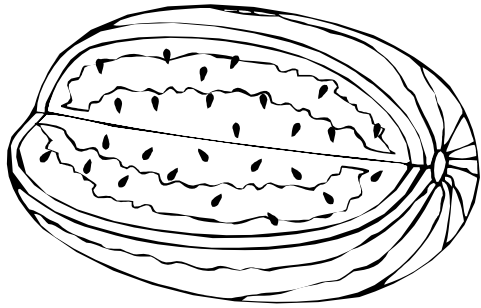

### RAGGRUPPAMENTI LOGICI

Far raggruppare tutti i **frutti**.

Far raggruppare tutti gli **ortaggi**.

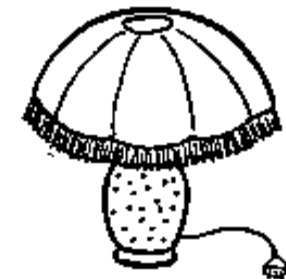

### RAGGRUPPAMENTI LOGICI

Far raggruppare tutti gli oggetti che **usano l'elettricità**.

Far raggruppare tutti gli oggetti che **usano il fuoco**.



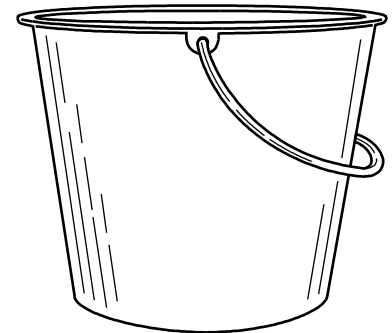
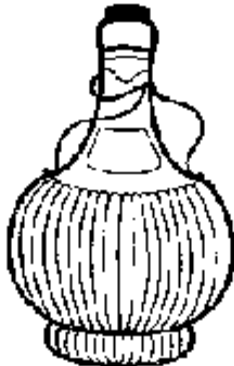
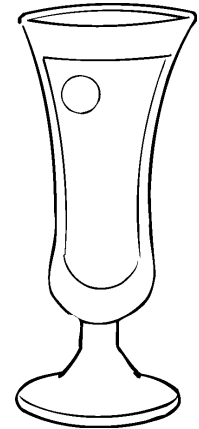

### RAGGRUPPAMENTI LOGICI

Far raggruppare tutti i recipienti per i **liquidi**.

Far raggruppare tutti i recipienti per i **solidi**.

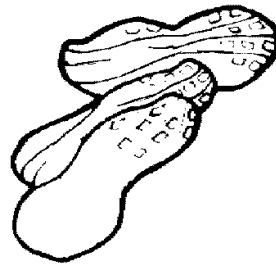
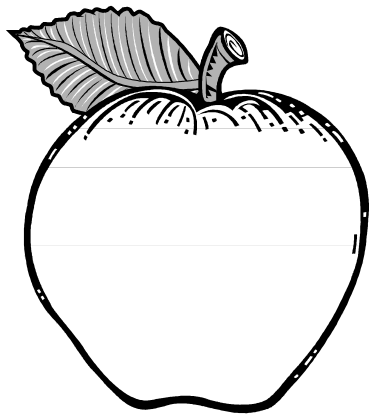
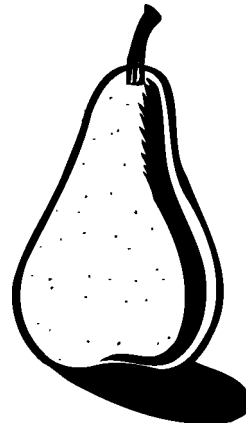

### RAGGRUPPAMENTI LOGICI

Far raggruppare tutta la **frutta morbida**.

Far raggruppare tutta la **frutta secca**.

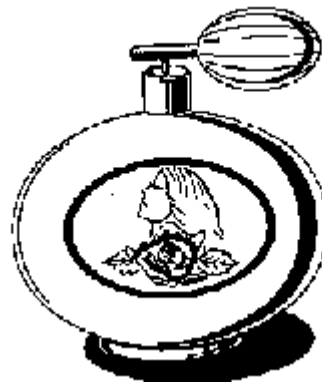
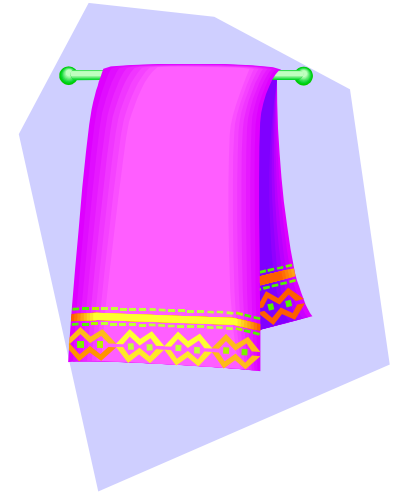
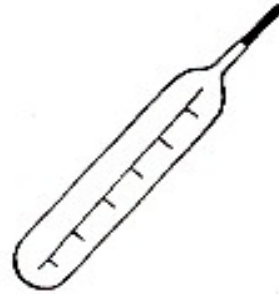
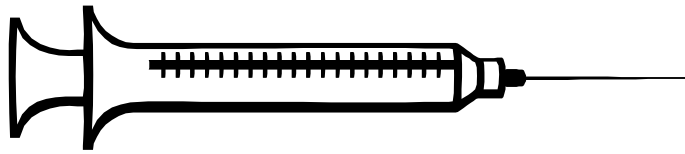

### RAGGRUPPAMENTI LOGICI

Far raggruppare tutti gli oggetti per la **pulizia personale** .

Far raggruppare tutti gli oggetti per la **cura delle malattie**.

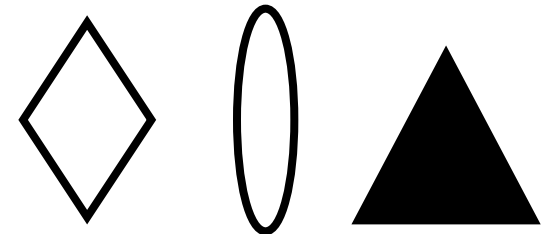
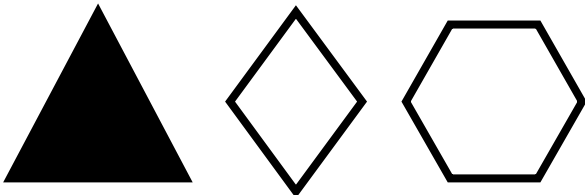
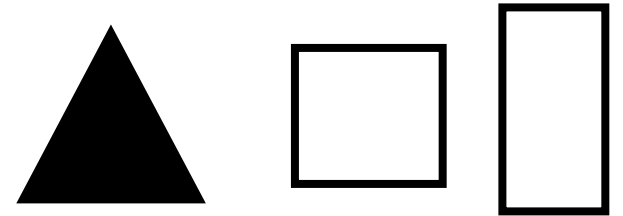
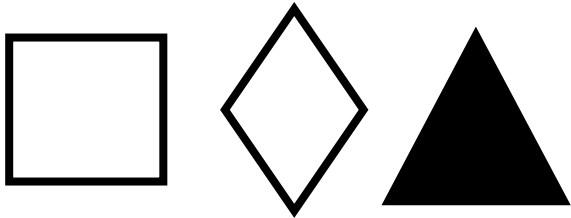
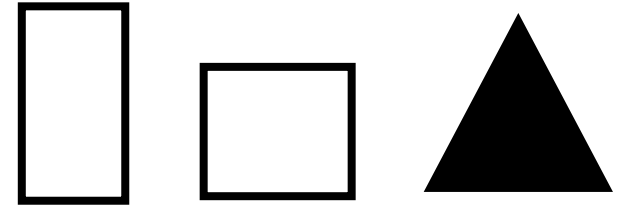
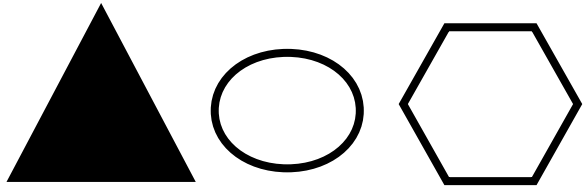

### RAGGRUPPAMENTI LOGICI

Far indicare i triangoli che stanno a **sinistra** delle altre figure .

Far indicare i triangoli che stanno a **destra** delle altre figure .

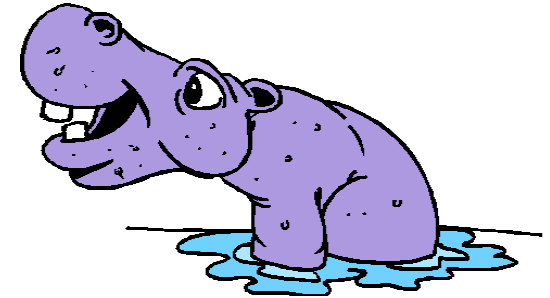
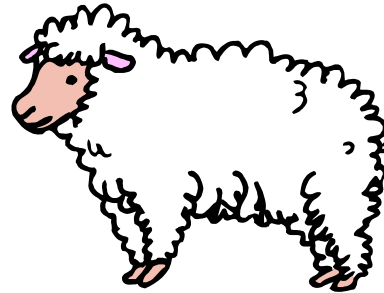
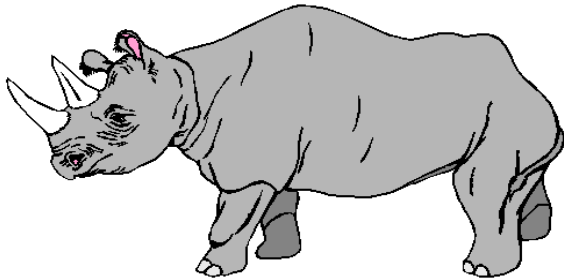
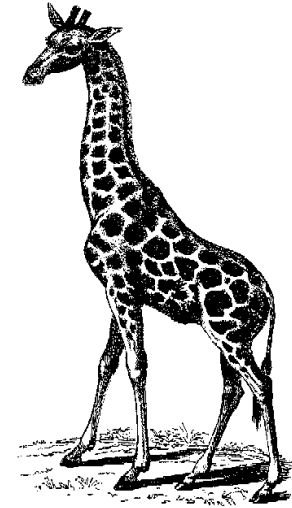
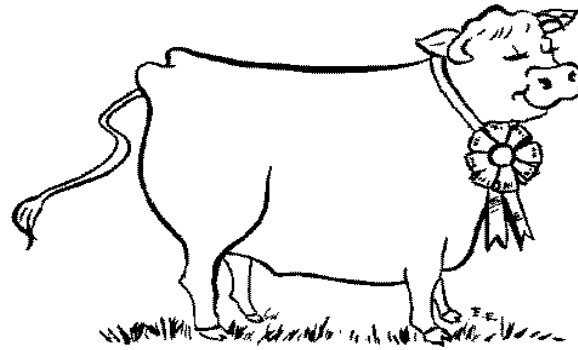
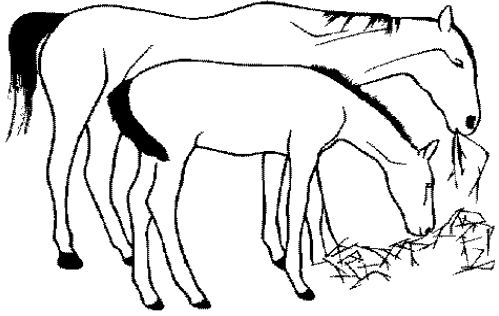

### RAGGRUPPAMENTI LOGICI

Far raggruppare tutti gli **animali domestici**.

Far raggruppare tutti gli **animali selvatici**.

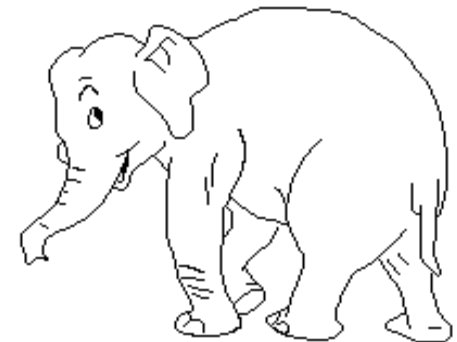
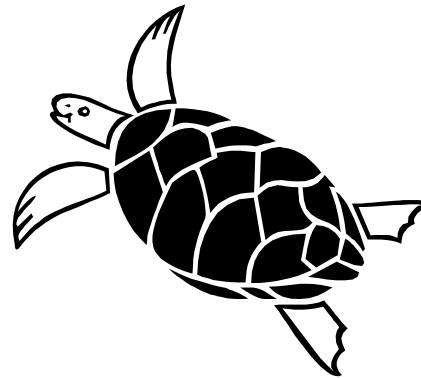
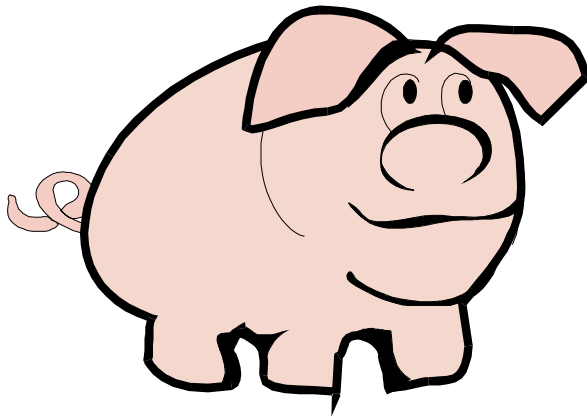
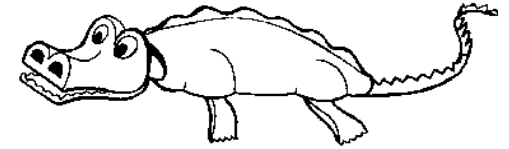
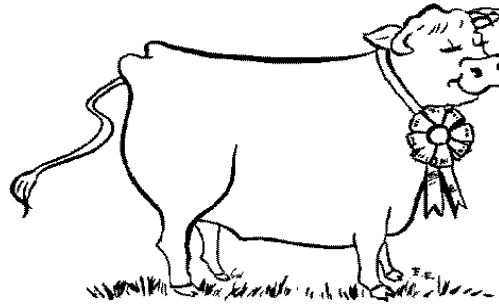

### RAGGRUPPAMENTI LOGICI

Far raggruppare tutti gli **animali che fanno le uova (ovipari)** .

Far raggruppare tutti gli **animali che allattano i piccoli (mammiferi)**.

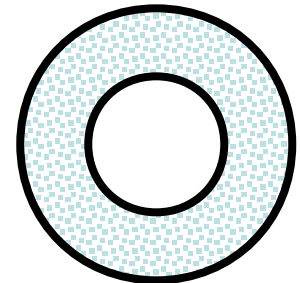
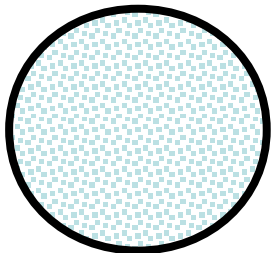
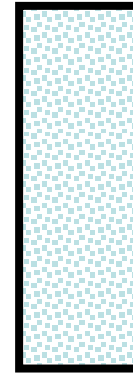
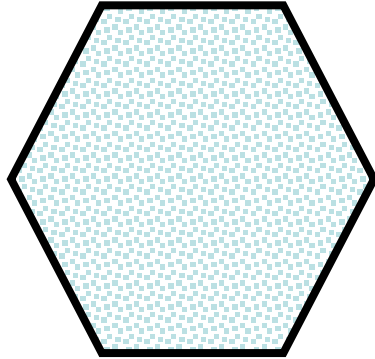
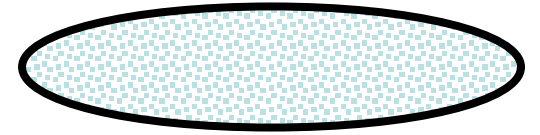
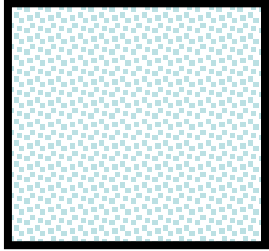

### RAGGRUPPAMENTI LOGICI

Far raggruppare tutte le **figure geometriche con i lati** .

Far raggruppare tutte le **figure geometriche con linee curve** .

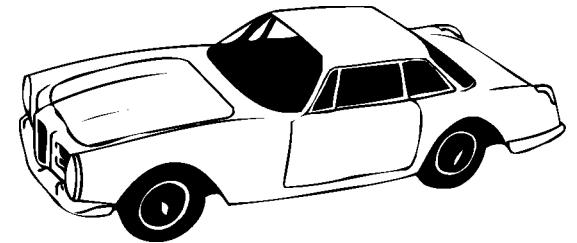
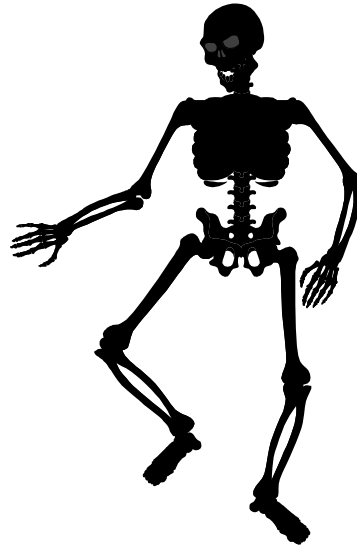
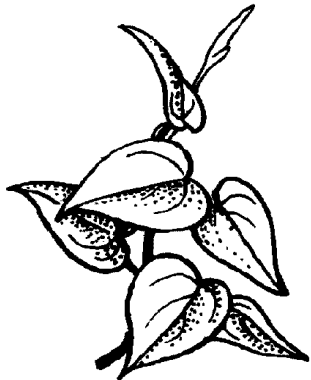
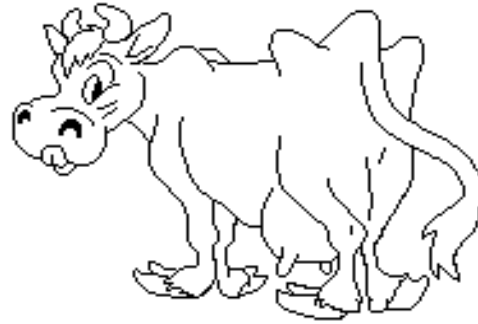

## RAGGRUPPAMENTI LOGICI

Far raggruppare tutti gli **esseri viventi**.

Far raggruppare tutte le **cose non viventi**.



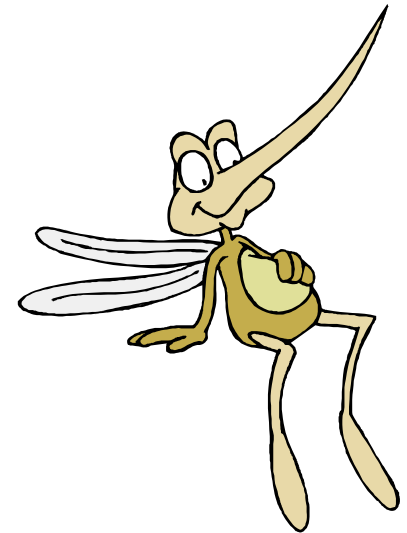
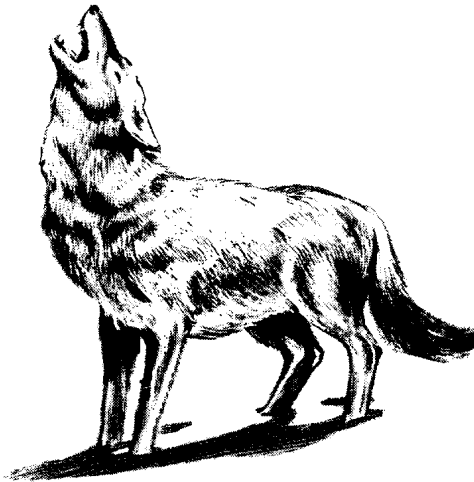
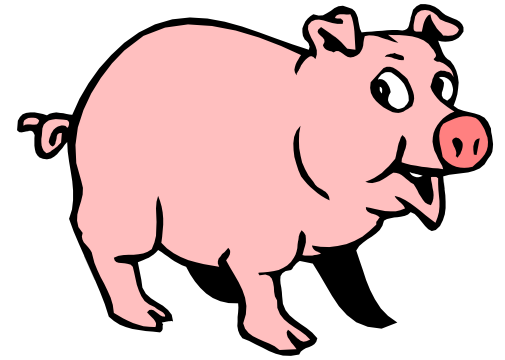
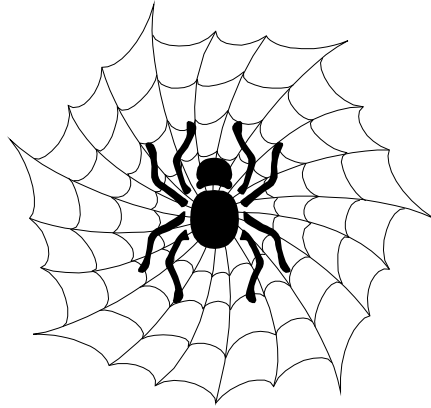
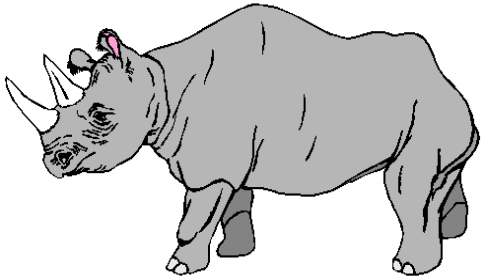

### RAGGRUPPAMENTI LOGICI

Far raggruppare tutti gli **animali che fanno le uova (ovipari)** .

Far raggruppare tutti gli **animali che allattano i piccoli (mammiferi)**.

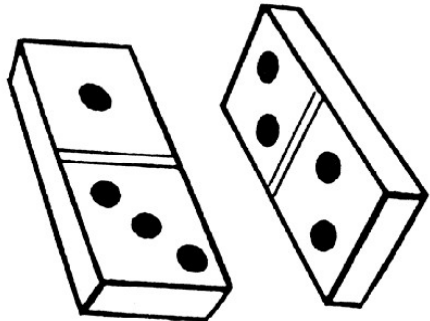
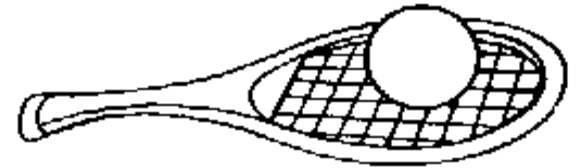
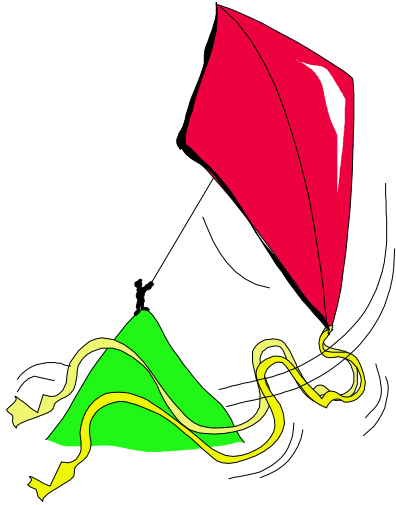

### RAGGRUPPAMENTI LOGICI

Far raggruppare tutti i **giochi da fare all'aria aperta.**

Far raggruppare tutti i **giochi da fare in casa.**



### RAGGRUPPAMENTI LOGICI

Far indicare le stelle **a destra** del tavolo.

Far indicare le stelle **a sinistra** del tavolo.

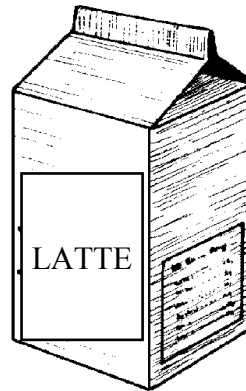
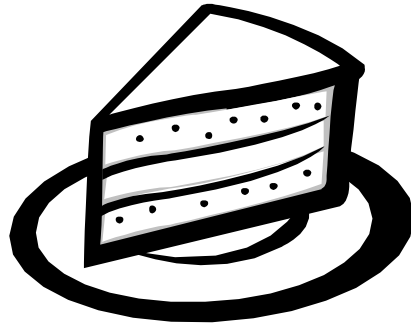
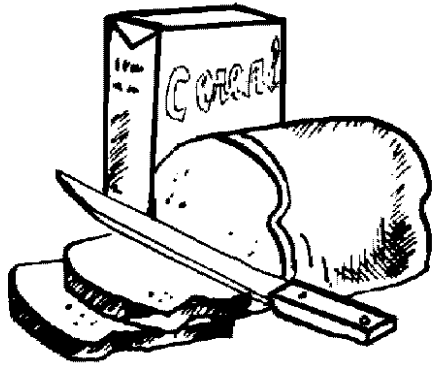

## RAGGRUPPAMENTI LOGICI

Far raggruppare tutti gli **alimenti solidi**.

Far raggruppare tutti gli **alimenti liquidi**.

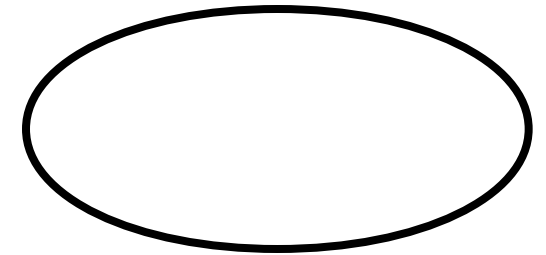
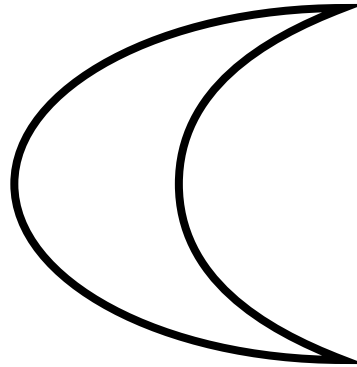
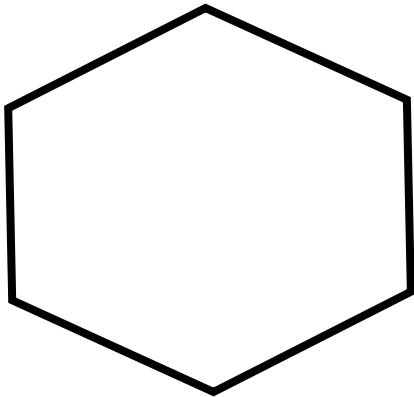
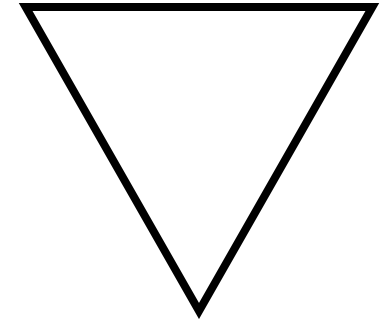
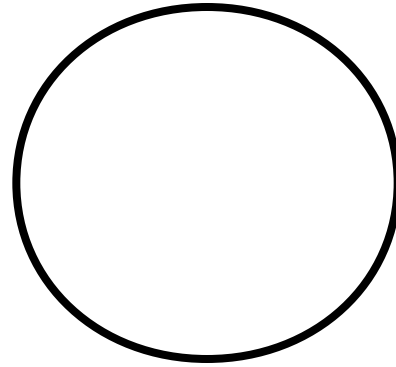
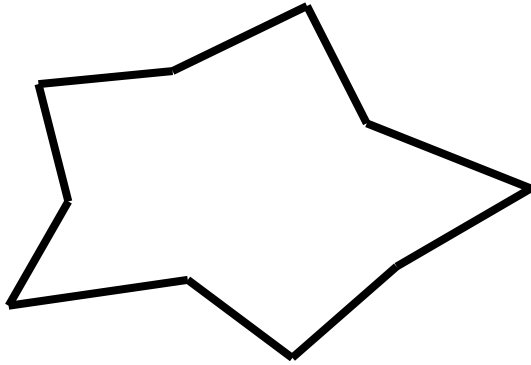

### RAGGRUPPAMENTI LOGICI

Far raggruppare tutte le **figure con i lati**.

Far raggruppare tutte le **figure con linee curve**.

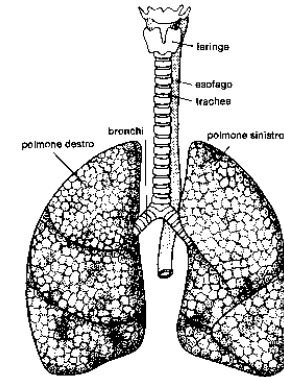
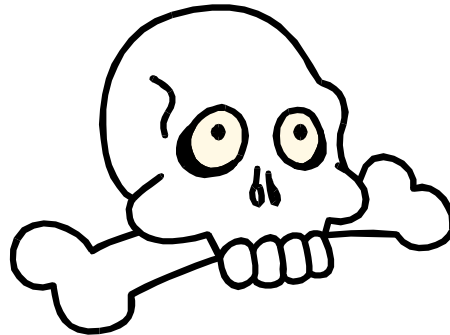
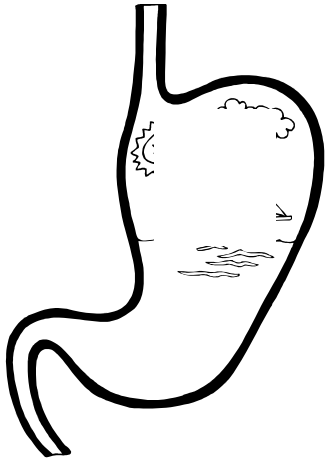
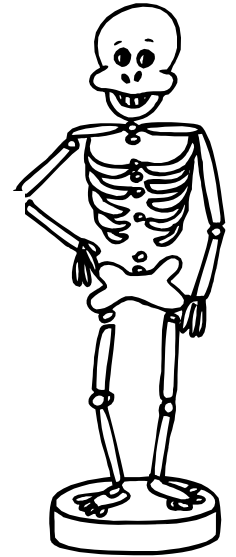
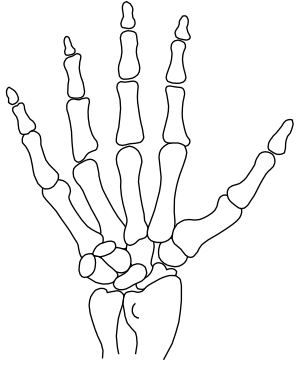

## RAGGRUPPAMENTI LOGICI

Far raggruppare tutti gli **organi interni dell'uomo**.

Far raggruppare tutte le **ossa umane**.

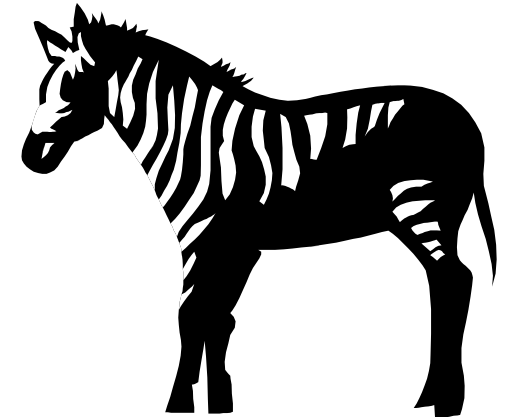
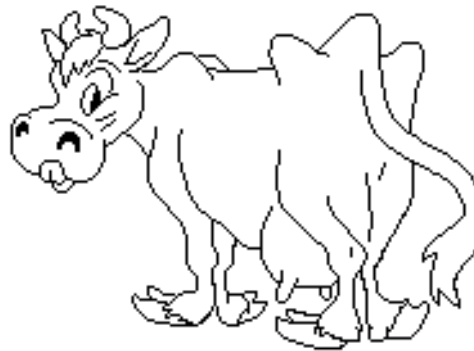
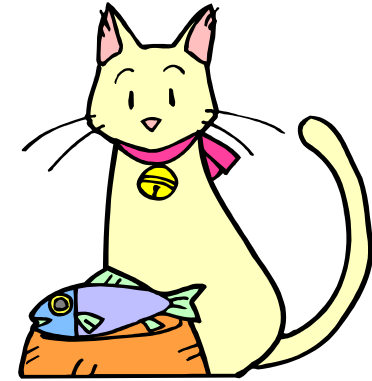
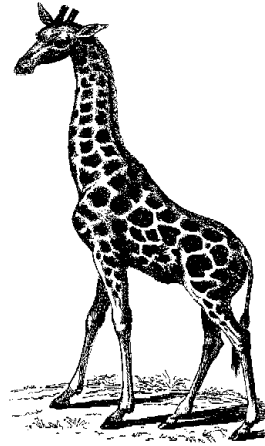
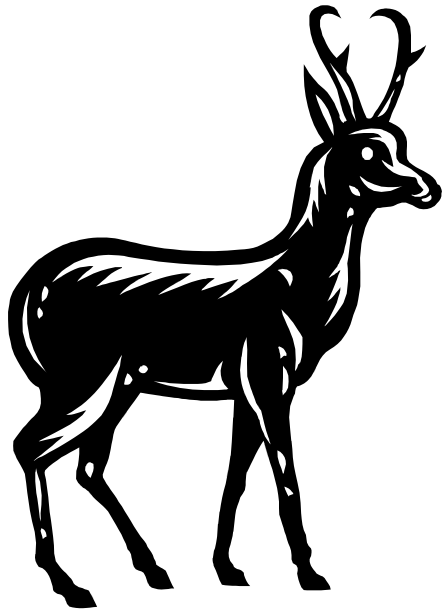

### RAGGRUPPAMENTI LOGICI

Far raggruppare tutti gli **animali domestici**.

Far raggruppare tutti gli **animali selvatici**.

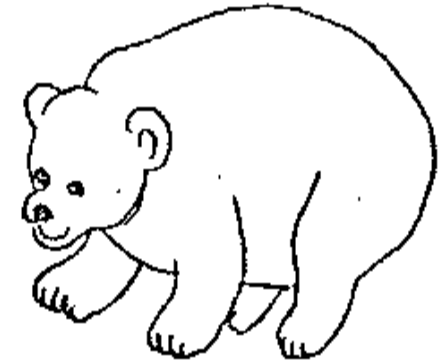
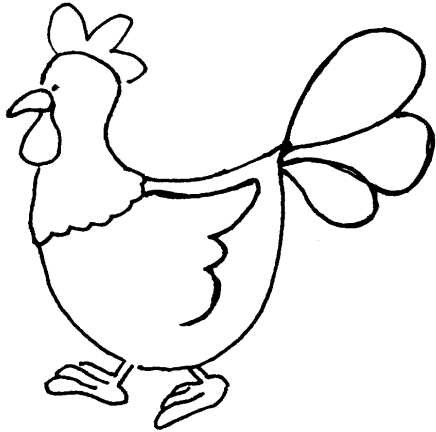

### RAGGRUPPAMENTI LOGICI

Far raggruppare tutti gli **animali con le ali**.

Far raggruppare tutti gli **animali senza le ali**.