

SVILUPPO LOGICO E PERCETTIVO

Emidio Tribulato



Volume 4

Emidio Tribulato

SVILUPPO LOGICO E PERCETTIVO

Volume quarto

Centro studi *LOGOS* – ONLUS - Messina



2010- Tutti i diritti riservati.

Sito web: www.cslogos.it – E - mail: postmaster@cslogos.it

ASSOCIAZIONI LOGICHE

L'attività di associare un oggetto, un animale, un vegetale o una forma geometrica ad un altro, ricercando un possibile legame logico di uso, funzione, forma, posizione nello spazio, somiglianza, causa - effetto, parte - tutto ecc. implica la stimolazione di processi di astrazione, classificazione ed organizzazione spaziale, basilari per lo sviluppo intellettuale.

UTILIZZAZIONE

Per utilizzare tali schede basta indicare al bambino l'immagine presente nella parte sinistra, chiedendo di associarla con un'altra disegnata nella parte destra. Nei bambini sordi, si cercherà di utilizzare il segno mimico che significa legame. Dopo che il bambino avrà effettuato l'associazione l'educatore chiarirà il motivo che lo ha spinto ad effettuare tale scelta.

VERBALIZZAZIONE

1^a Fase

Inizialmente per questa attività chiederemo al bambino solo il nome degli oggetti che si associano.

2^a Fase.

In un secondo momento, sarà il bambino stesso ad esplicitare il motivo che lo ha spinto ad effettuare quell'associazione.

ETA' DI RIFERIMENTO

Tre anni nello sviluppo logico.

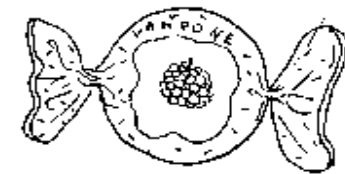
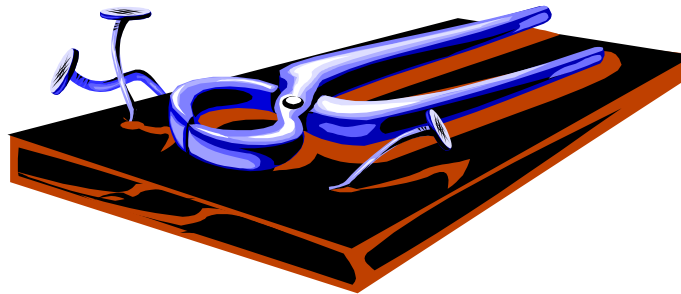
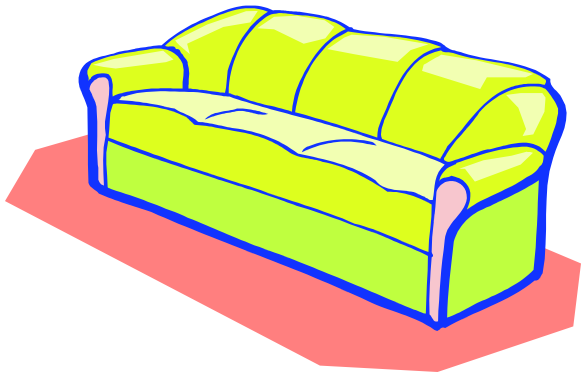
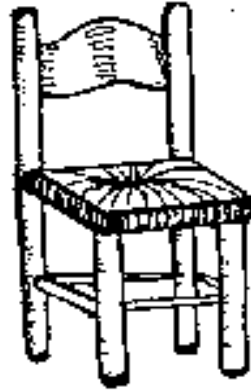
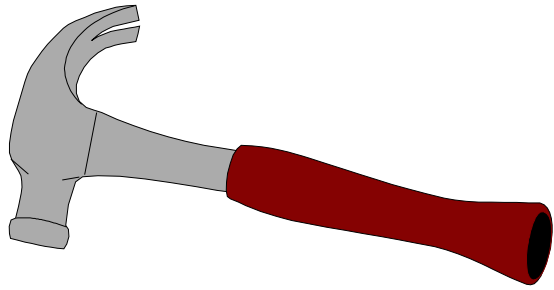

ASSOCIAZIONI LOGICHE

Far denominare e associare le immagini secondo un legame logico.

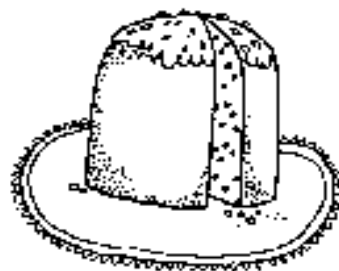
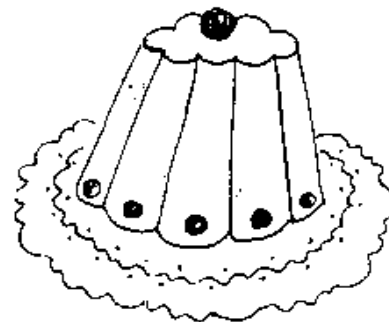
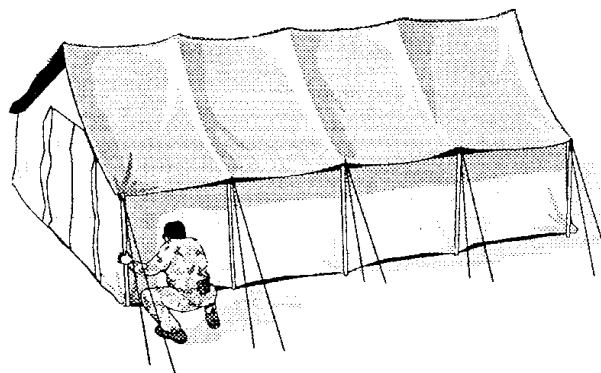

ASSOCIAZIONI LOGICHE

Far denominare e associare le immagini secondo un legame logico.

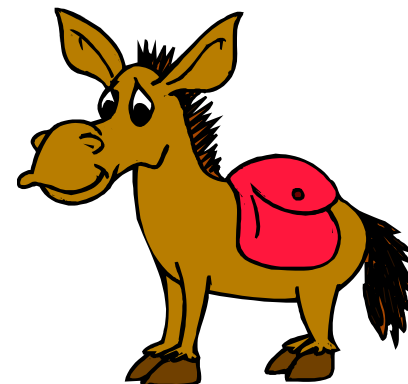
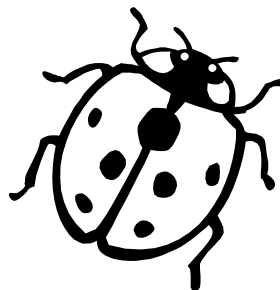
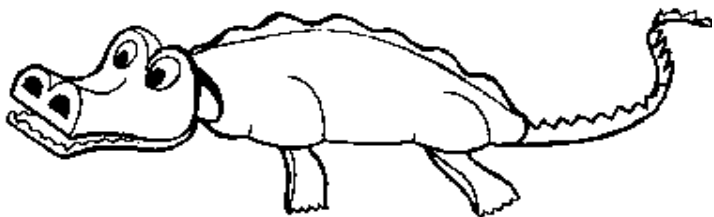
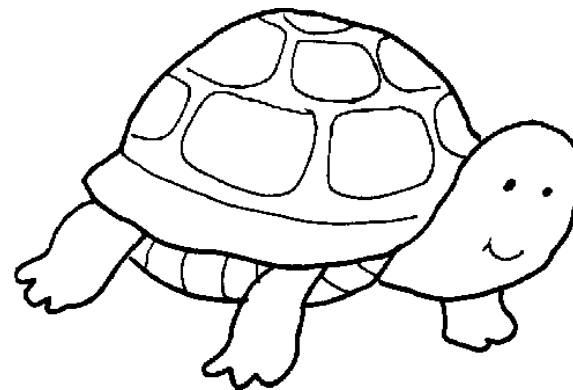
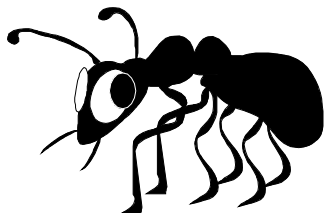

ASSOCIAZIONI LOGICHE

Far denominare e associare le immagini secondo un legame logico.

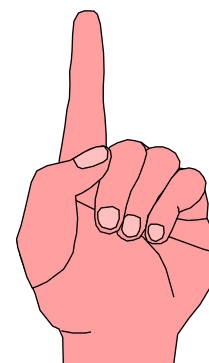
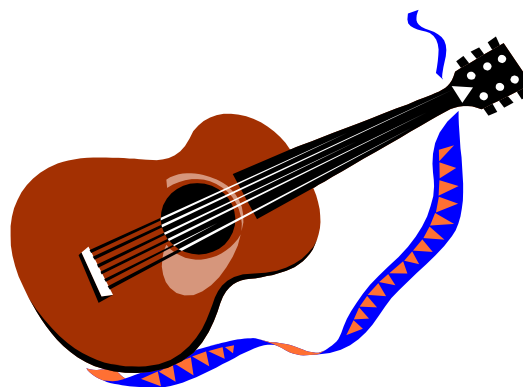
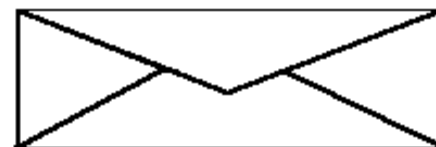
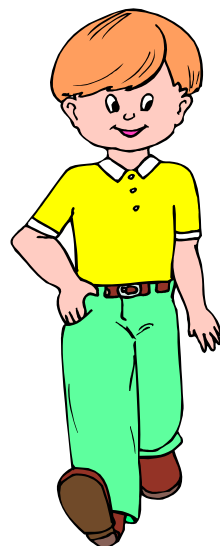

ASSOCIAZIONI LOGICHE

Far denominare e associare le immagini secondo un legame logico.

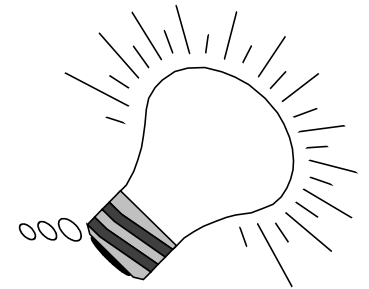
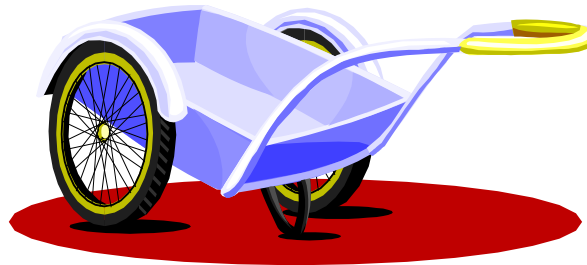
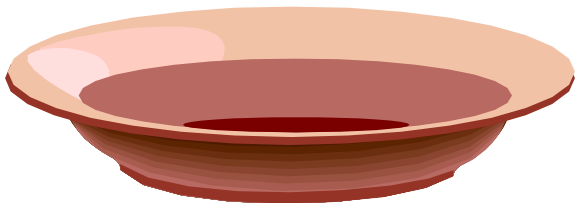
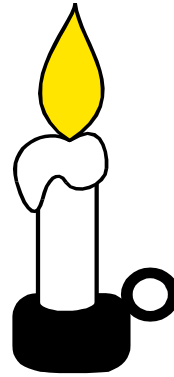

ASSOCIAZIONI LOGICHE

Far denominare e associare le immagini secondo un legame logico.

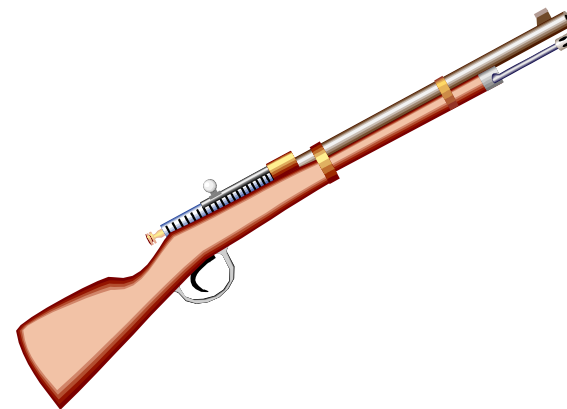
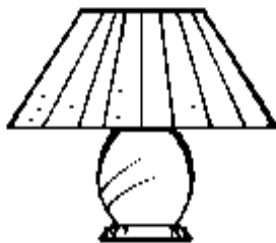
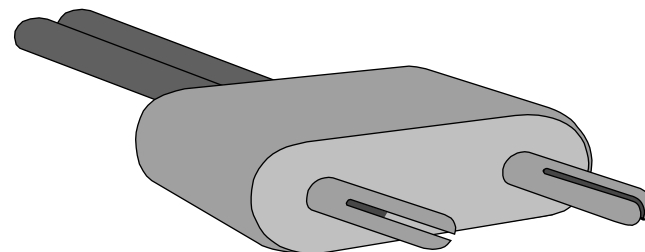

ASSOCIAZIONI LOGICHE

Far denominare e associare le immagini secondo un legame logico.

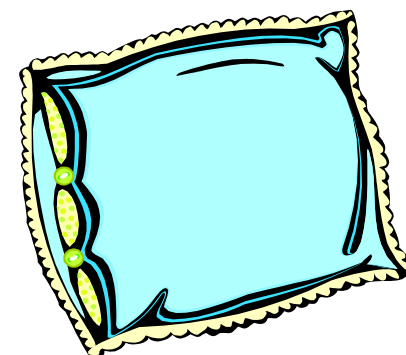
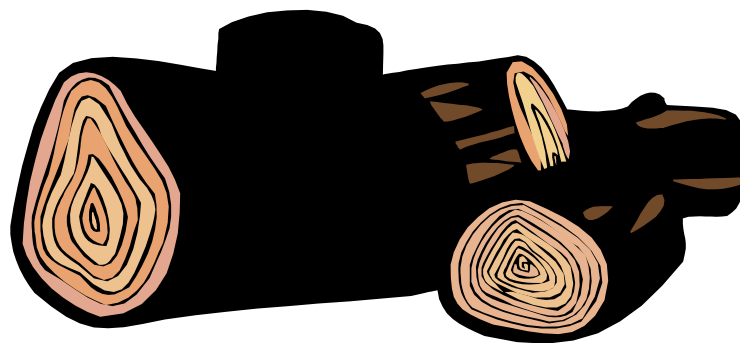
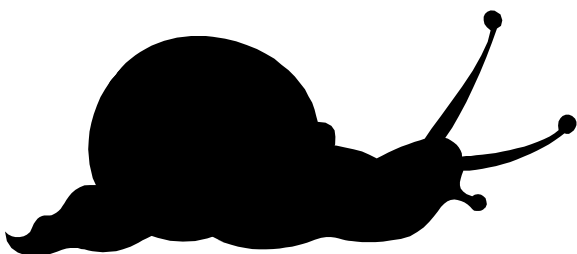
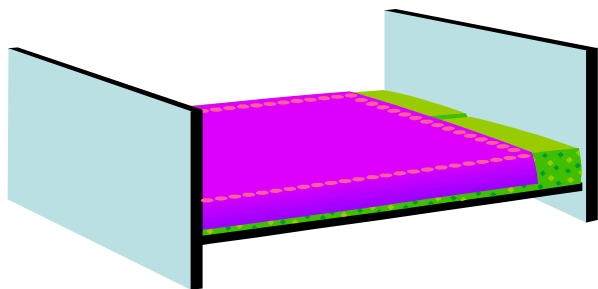

ASSOCIAZIONI LOGICHE

Far denominare e associare le immagini secondo un legame logico.

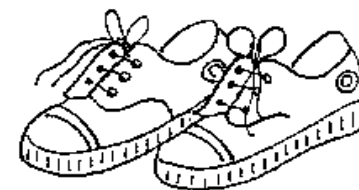
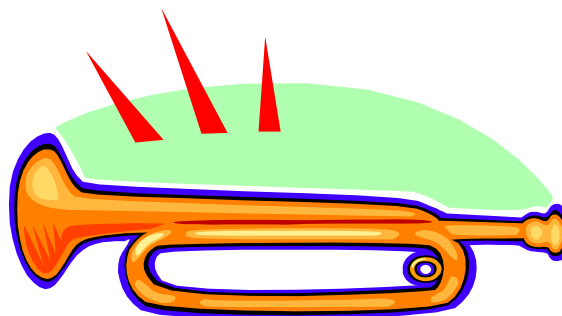
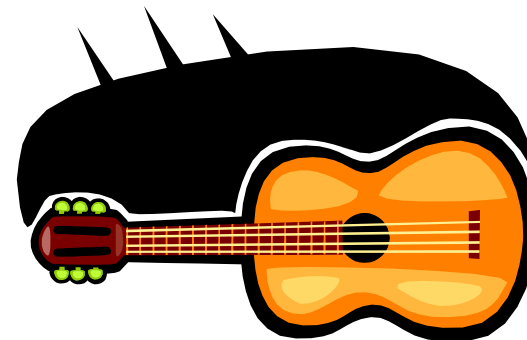
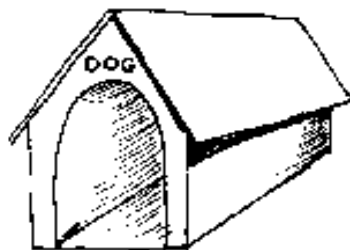

ASSOCIAZIONI LOGICHE

Far denominare e associare le immagini secondo un legame logico.

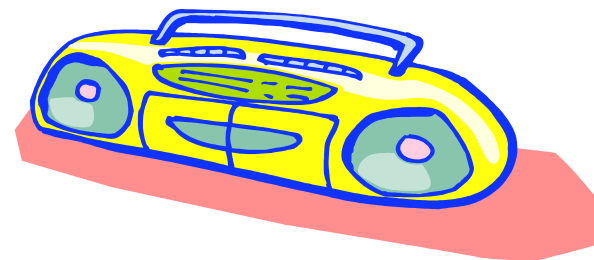
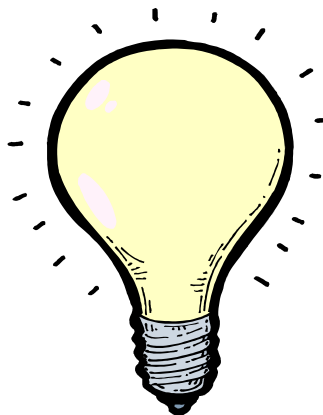
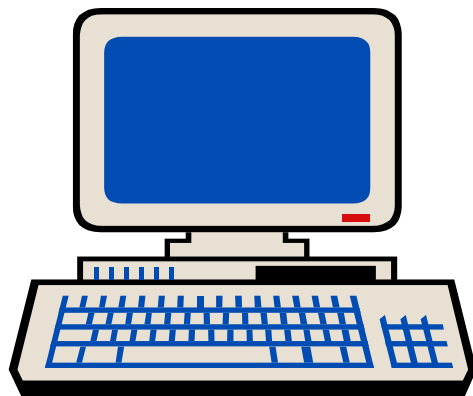
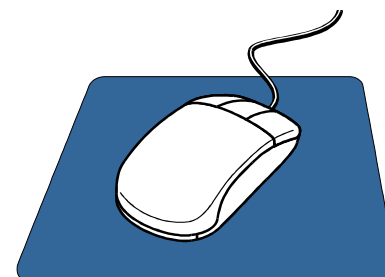
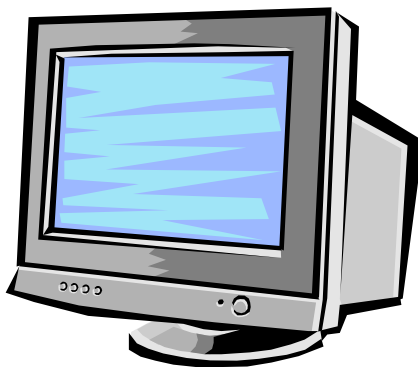

ASSOCIAZIONI LOGICHE

Far denominare e associare le immagini secondo un legame logico.

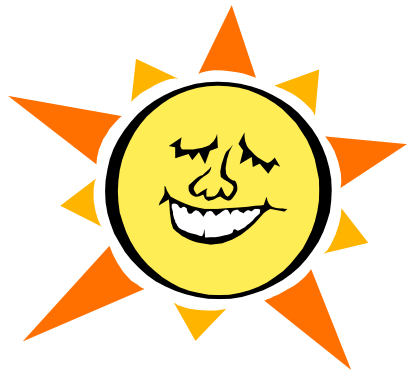
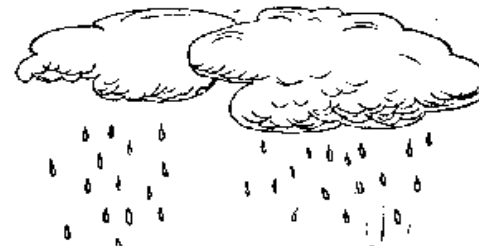
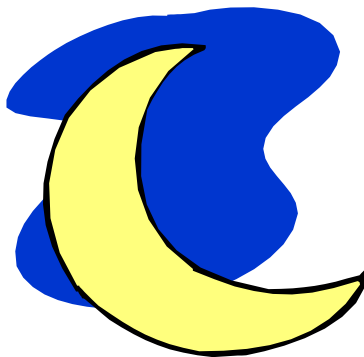

ASSOCIAZIONI LOGICHE

Far denominare e associare le immagini secondo un legame logico.

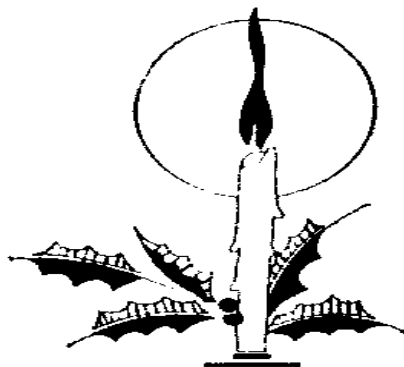
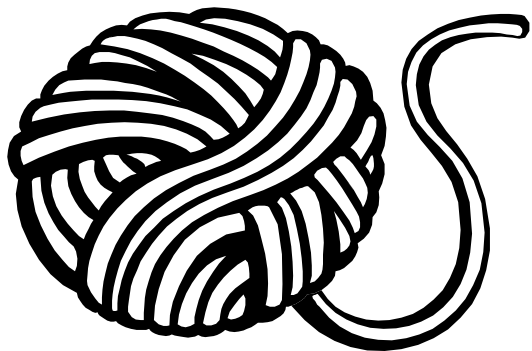
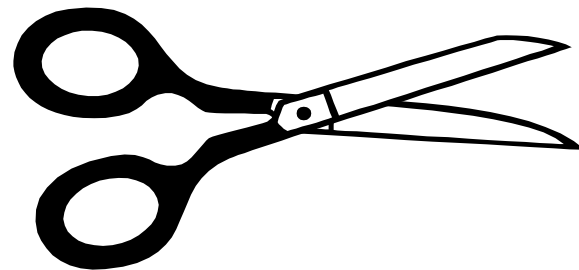
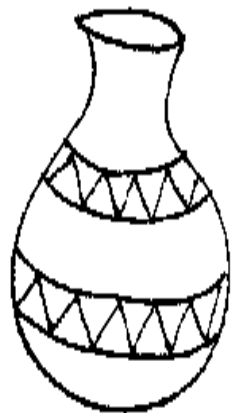

ASSOCIAZIONI LOGICHE

Far denominare e associare le immagini secondo un legame logico.

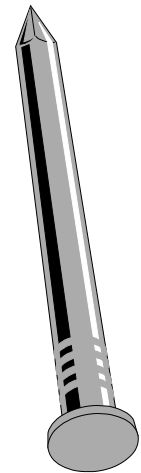
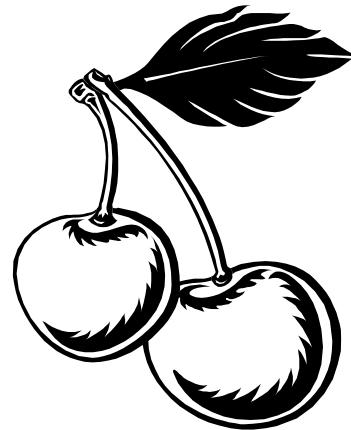
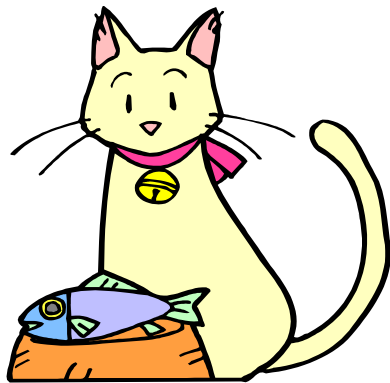
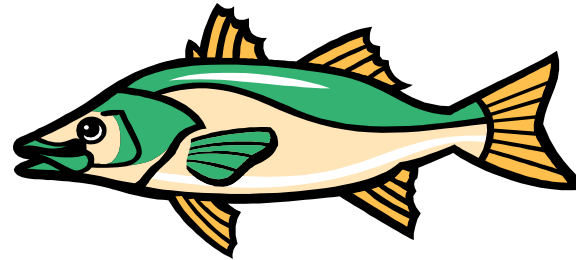
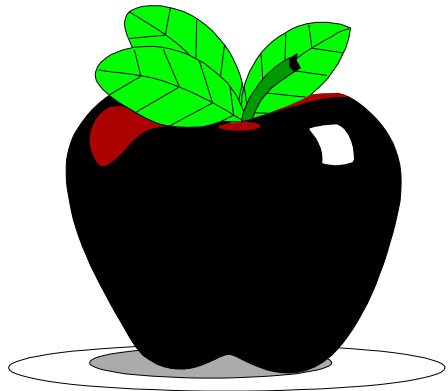

ASSOCIAZIONI LOGICHE

Far denominare e associare le immagini secondo un legame logico.

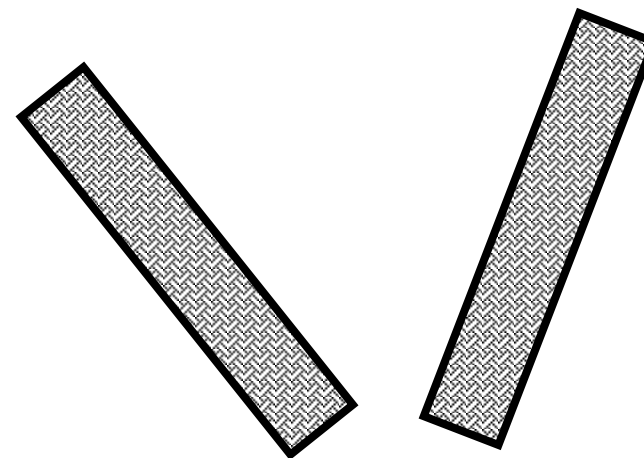
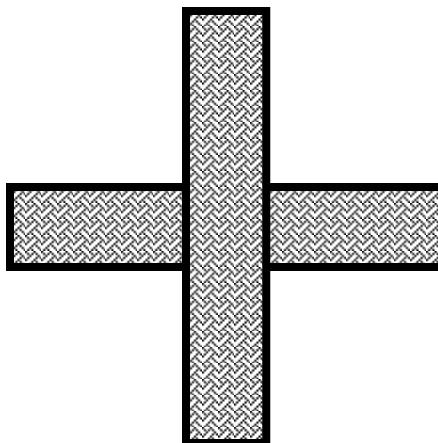
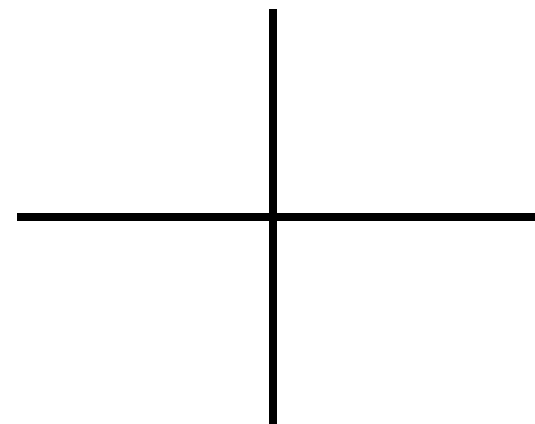
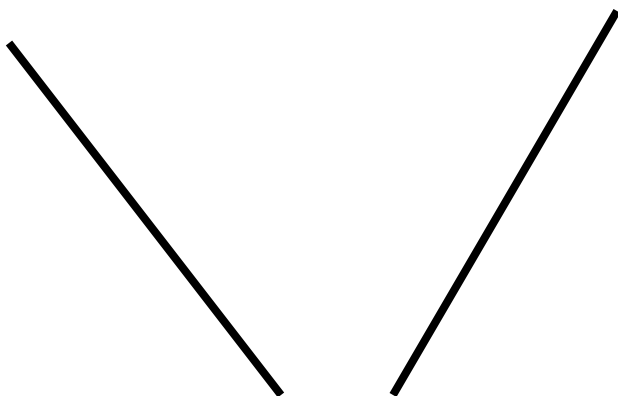

ASSOCIAZIONI LOGICHE

Far associare le immagini secondo un legame logico.

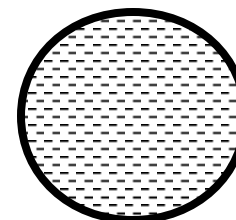
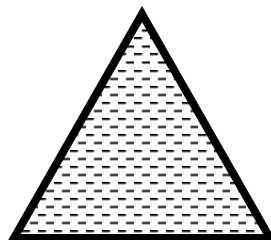
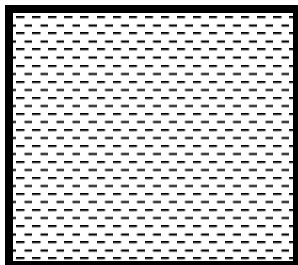
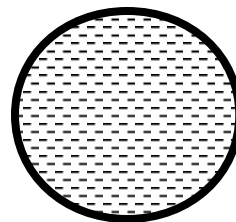
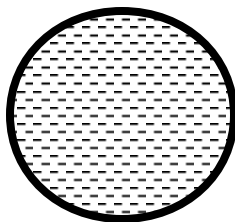
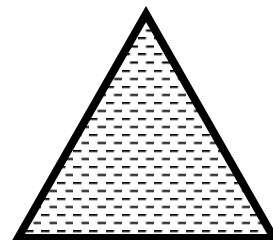
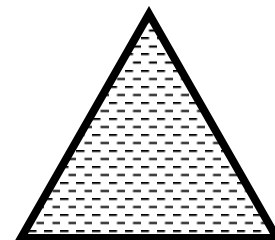
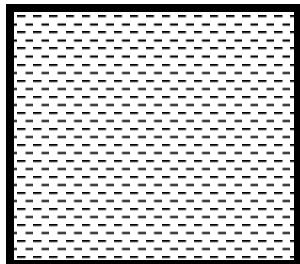
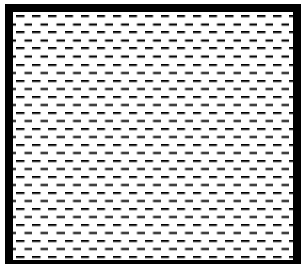

ASSOCIAZIONI LOGICHE

Far associare le immagini secondo un legame logico.

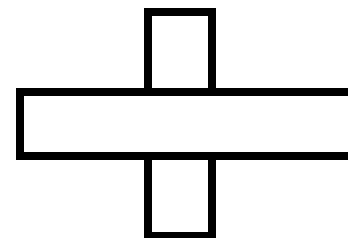
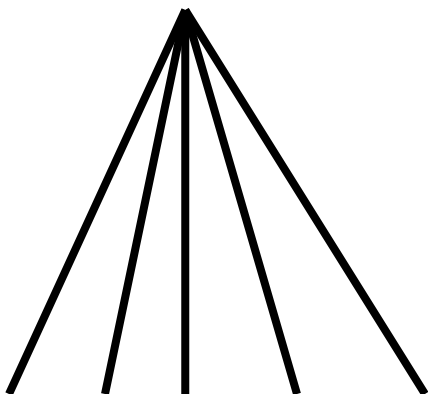
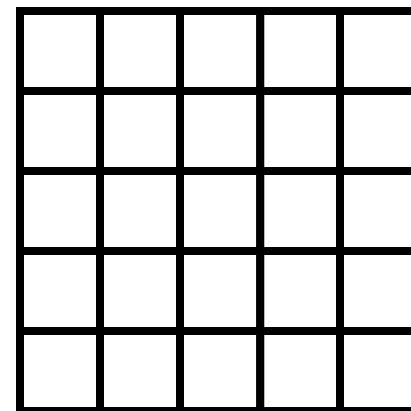
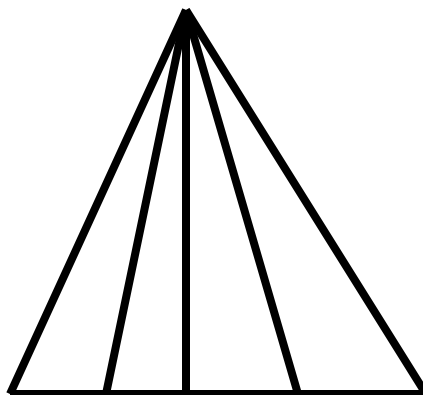
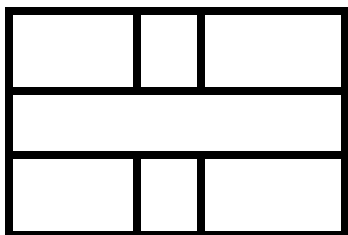

ASSOCIAZIONI LOGICHE

Far associare le immagini secondo un legame logico.

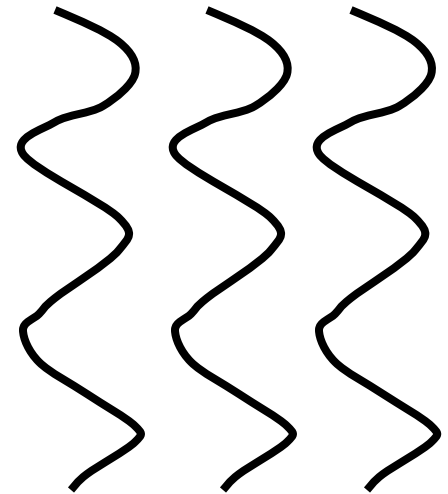
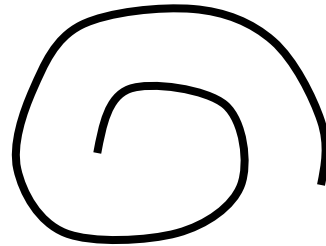
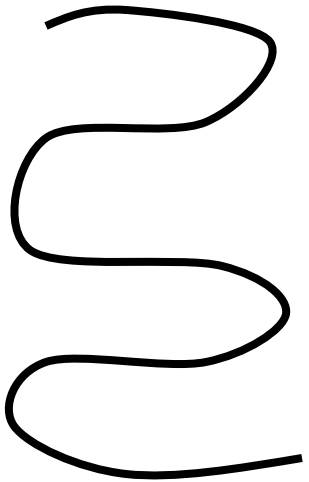
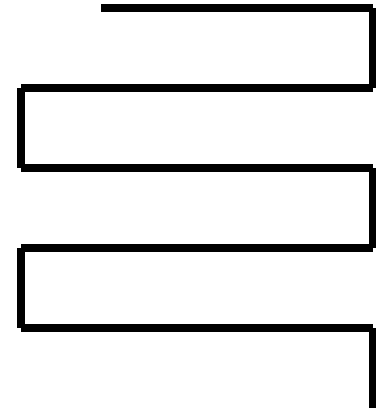
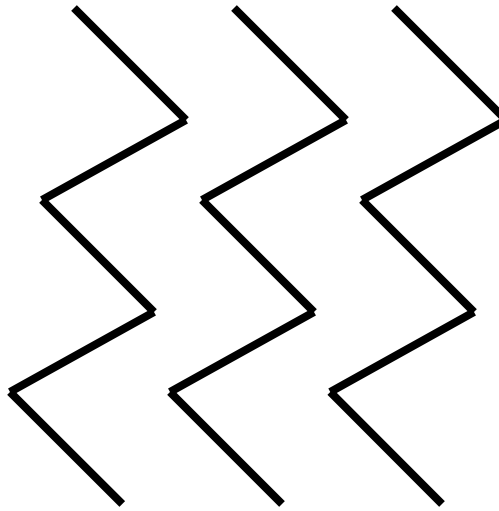
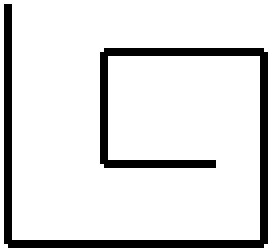

ASSOCIAZIONI LOGICHE

Far associare le immagini secondo un legame logico.

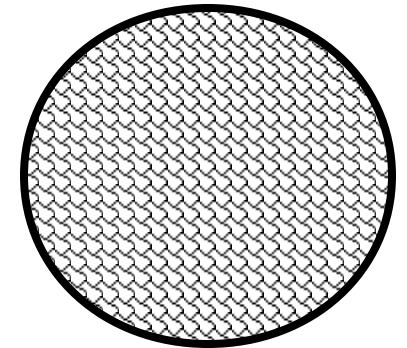
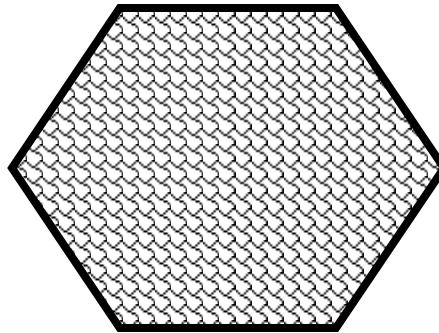
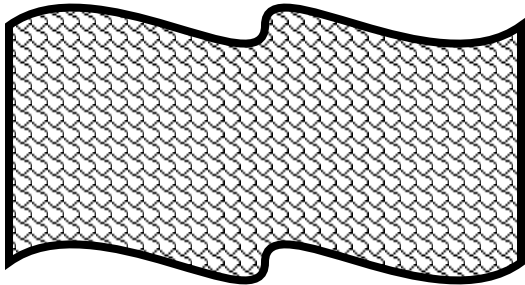
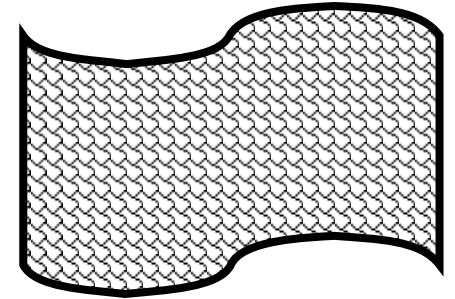
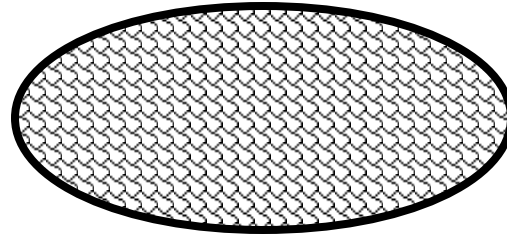
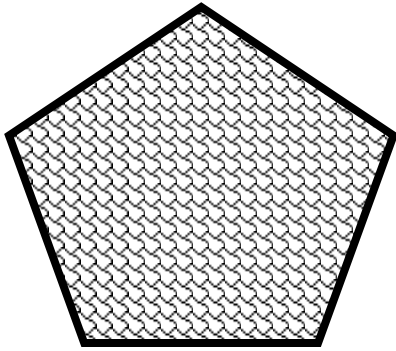

ASSOCIAZIONI LOGICHE

Far associare le immagini secondo un legame logico.

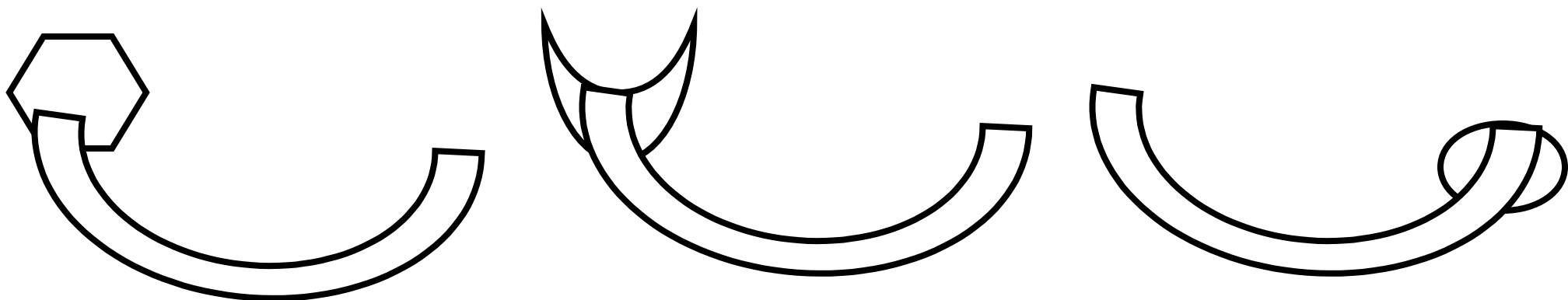
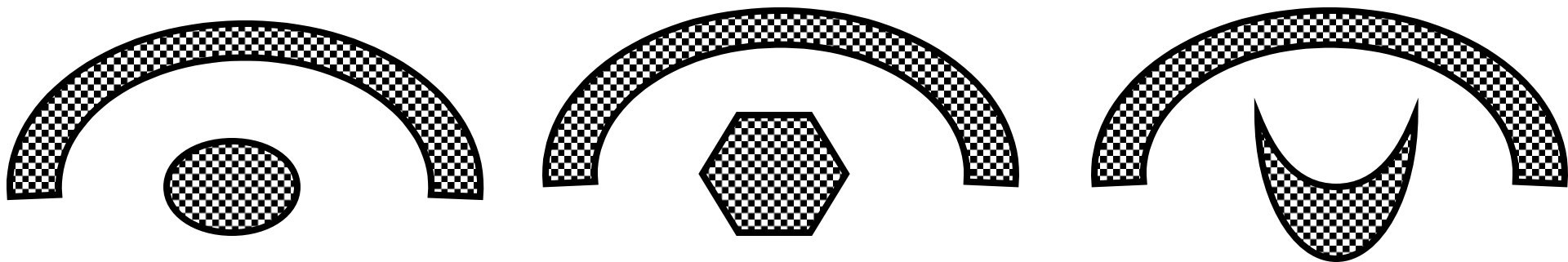

ASSOCIAZIONI LOGICHE

Far associare le immagini secondo un legame logico.

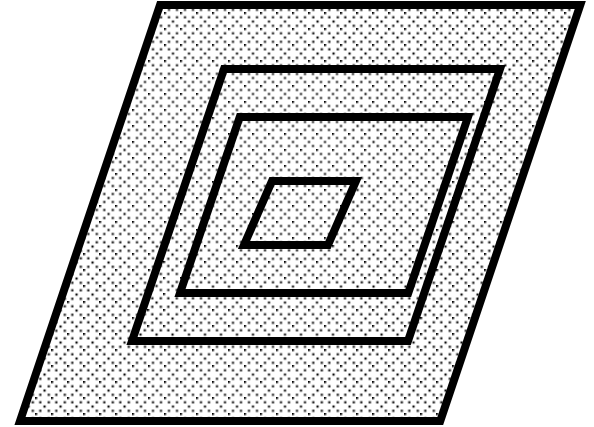
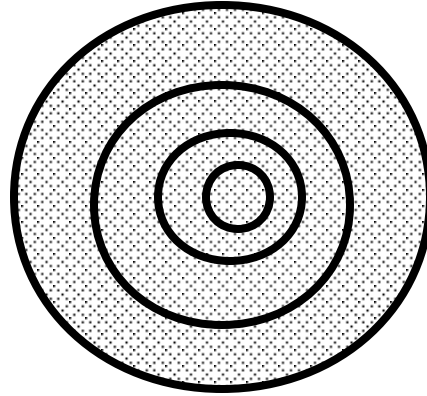
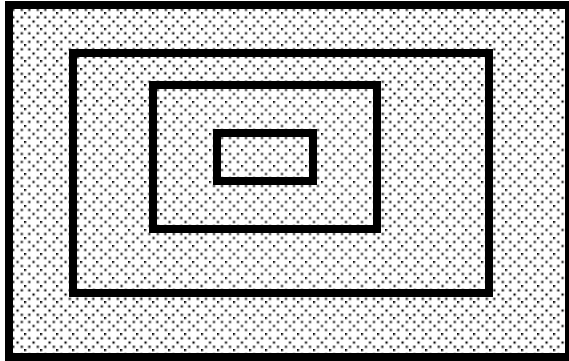

ASSOCIAZIONI LOGICHE

Far associare le immagini secondo un legame logico.

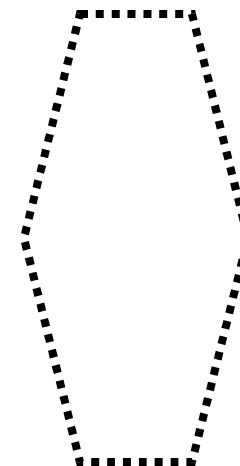
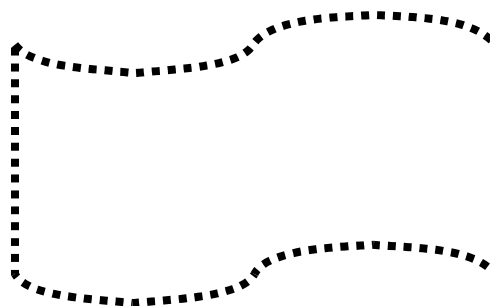
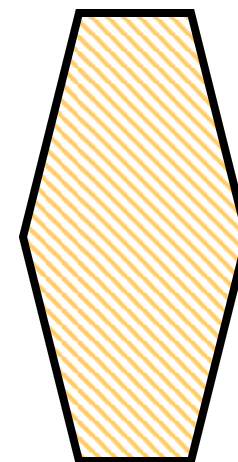
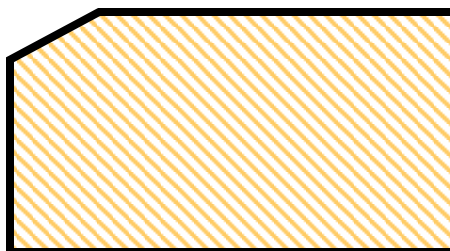
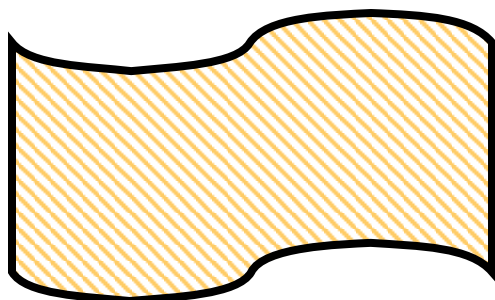

ASSOCIAZIONI LOGICHE

Far associare le immagini secondo un legame logico.

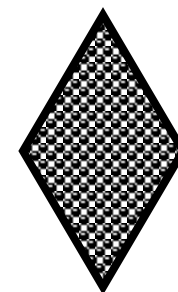
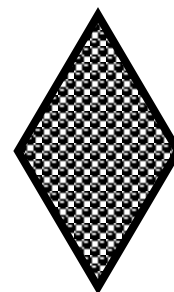
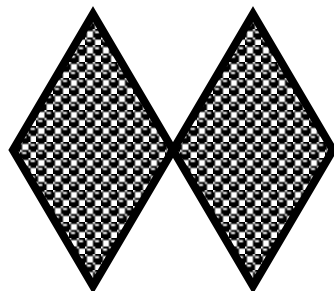
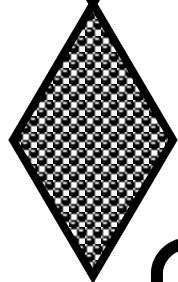
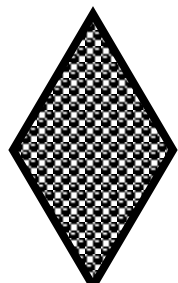
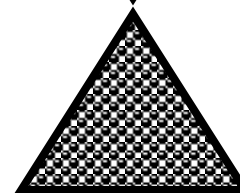
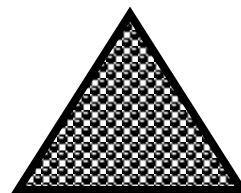
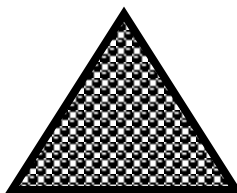
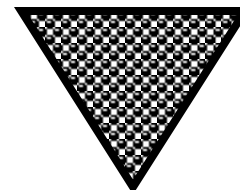
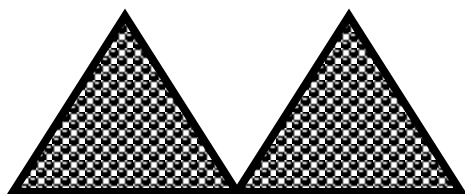

ASSOCIAZIONI LOGICHE

Far associare le immagini secondo un legame logico.

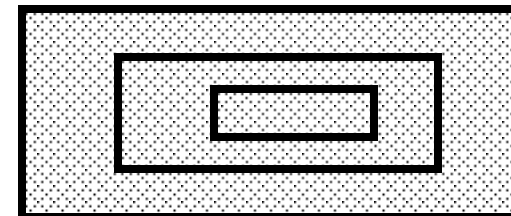
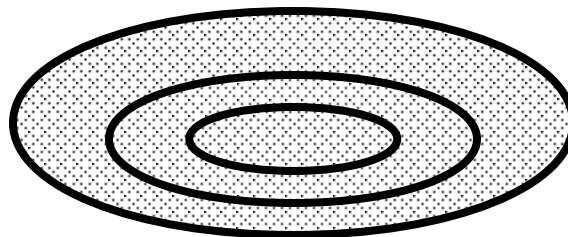
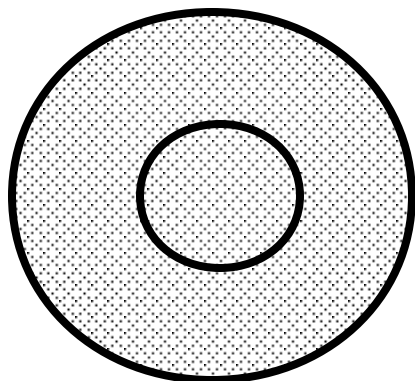
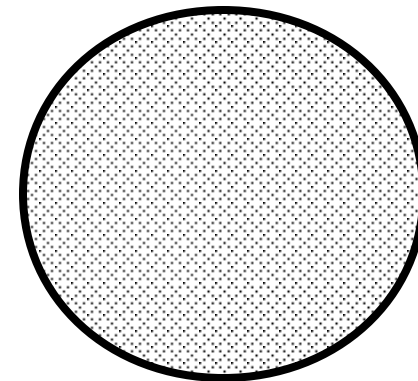
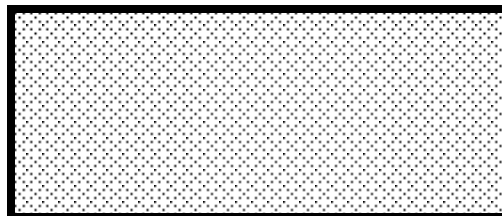
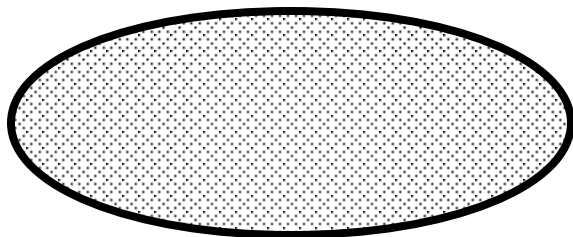

ASSOCIAZIONI LOGICHE

Far associare le immagini secondo un legame logico.

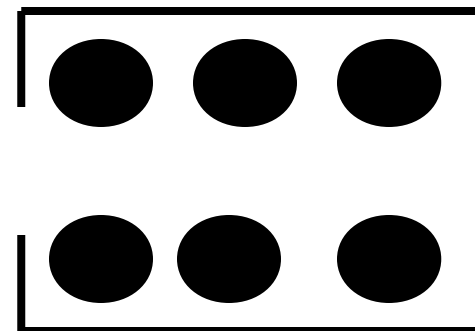
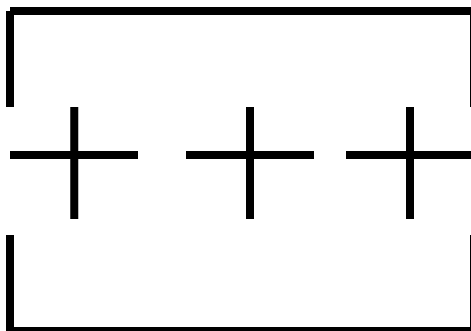
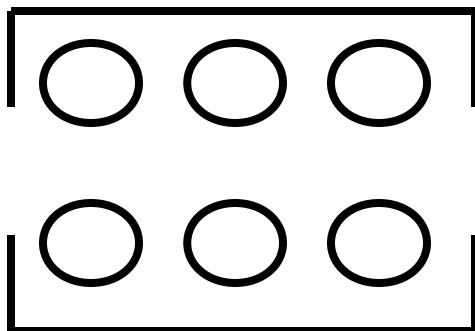
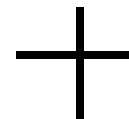

ASSOCIAZIONI LOGICHE

Far associare le immagini secondo un legame logico.

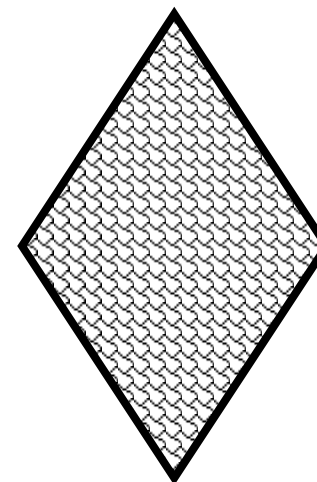
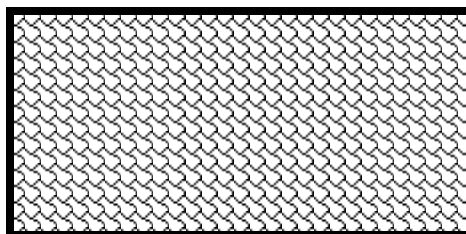
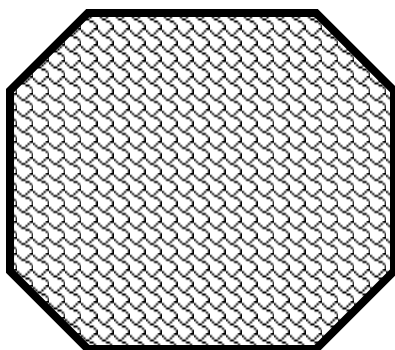
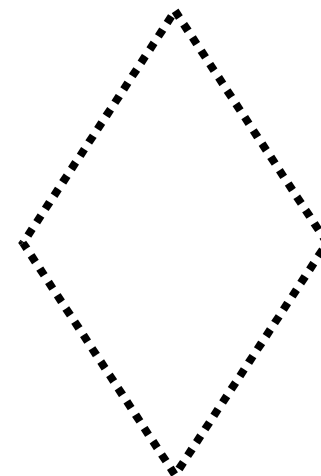
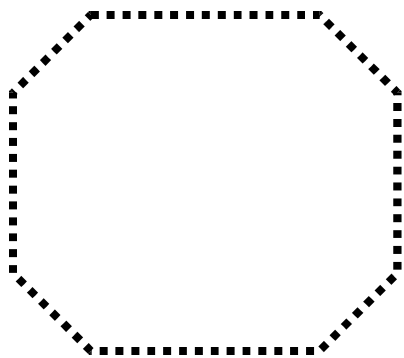

ASSOCIAZIONI LOGICHE

Far associare le immagini secondo un legame logico.

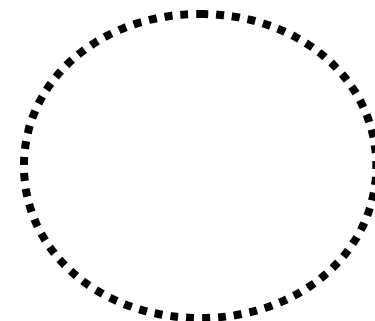
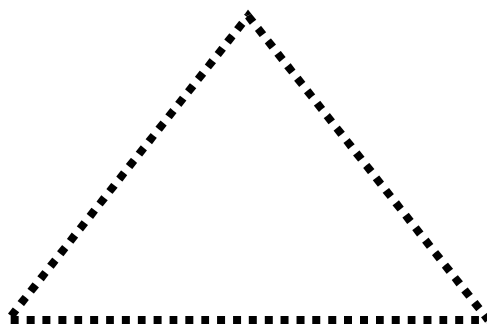
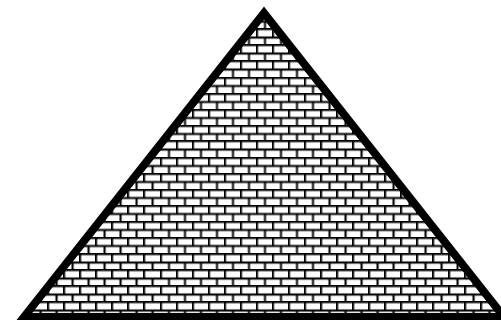
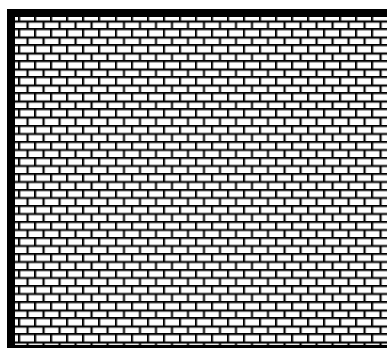
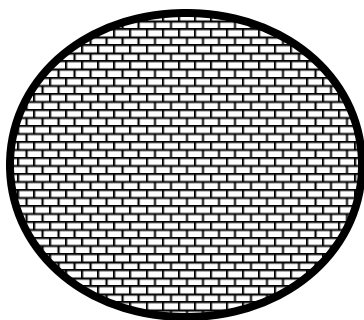

ASSOCIAZIONI LOGICHE

Far associare le immagini secondo un legame logico.

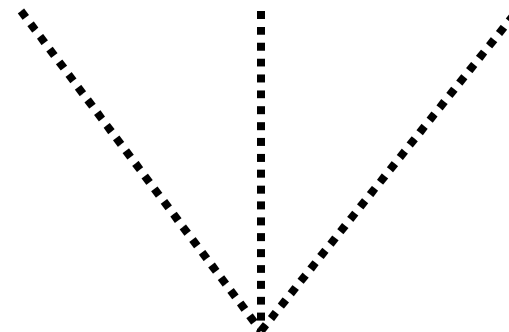
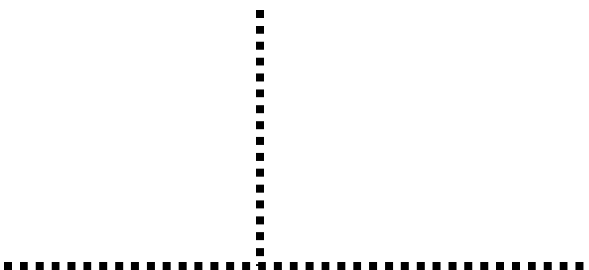
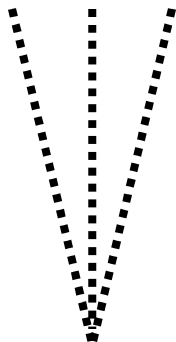
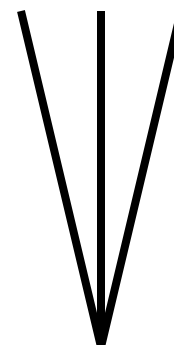
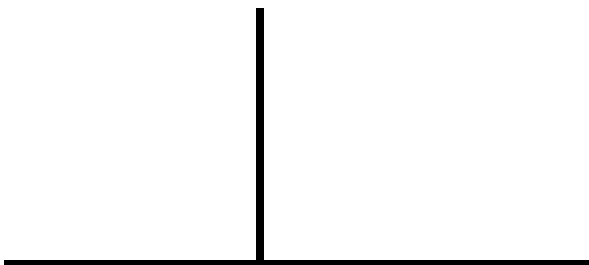
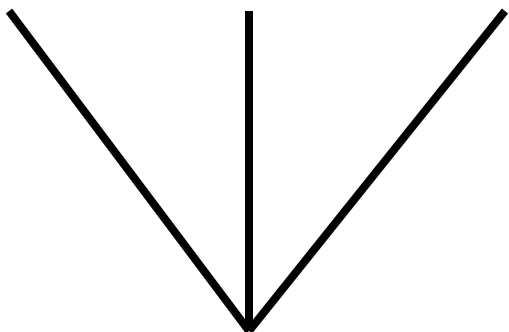

ASSOCIAZIONI LOGICHE

Far associare le immagini secondo un legame logico.

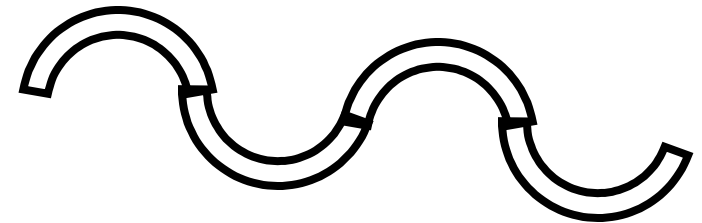
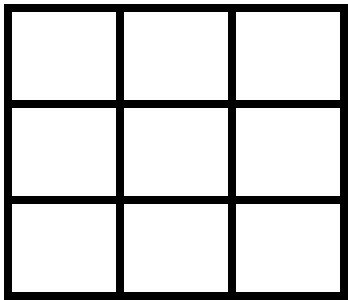
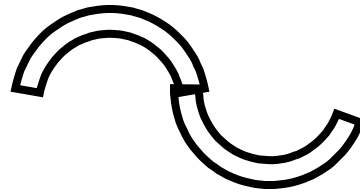
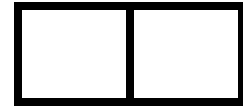

ASSOCIAZIONI LOGICHE

Far associare le immagini secondo un legame logico.

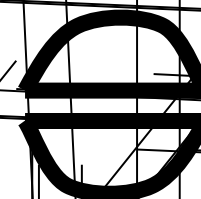
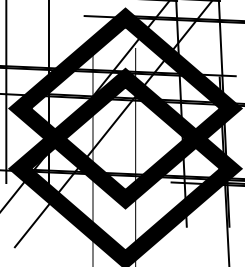
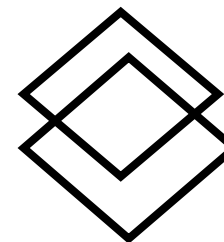
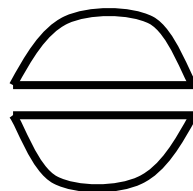

ASSOCIAZIONI LOGICHE

Far associare le immagini secondo un legame logico.

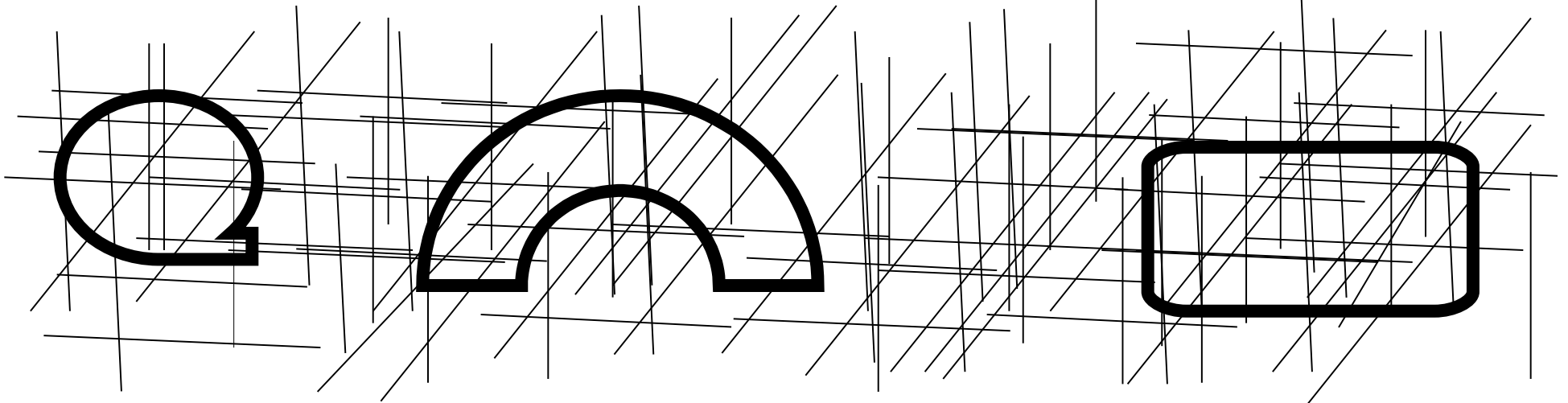
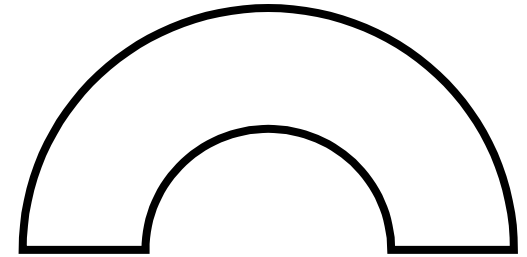
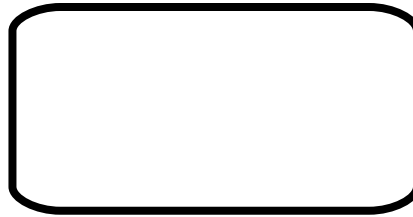
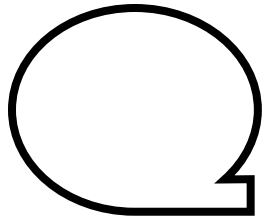

ASSOCIAZIONI LOGICHE

Far associare le immagini secondo un legame logico.

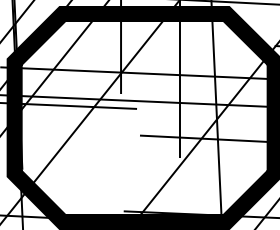
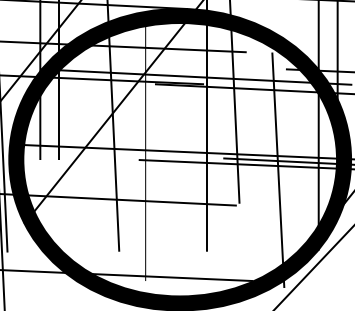
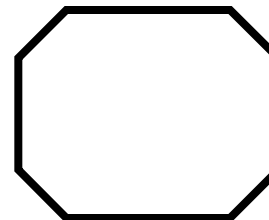
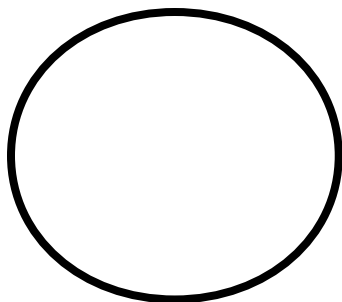
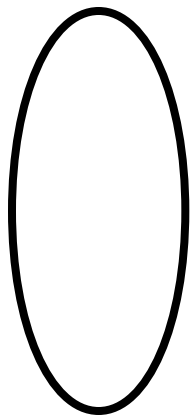

ASSOCIAZIONI LOGICHE

Far associare le immagini secondo un legame logico.

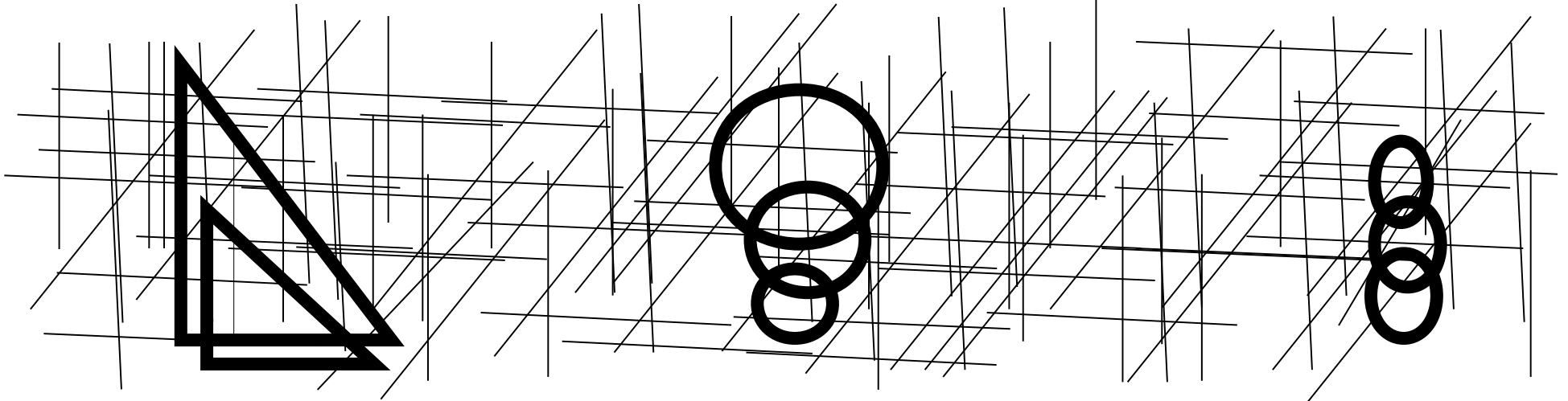
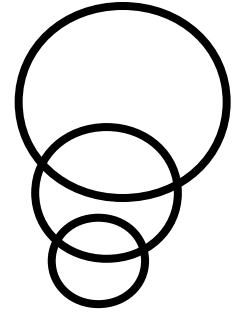
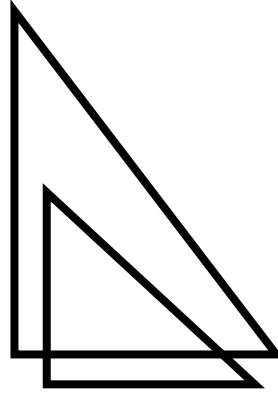

ASSOCIAZIONI LOGICHE

Far associare le immagini secondo un legame logico.

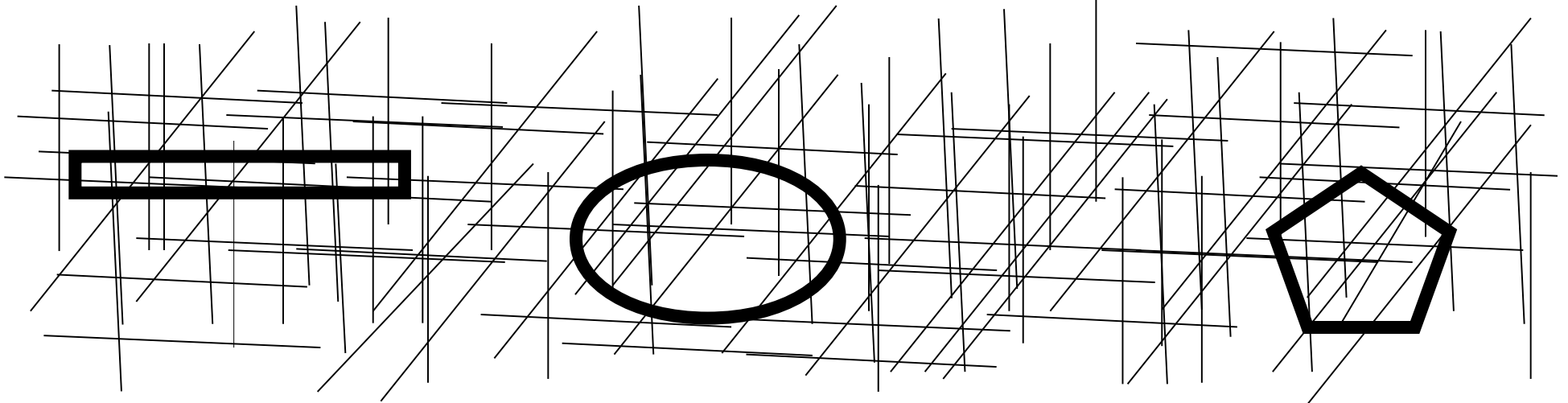
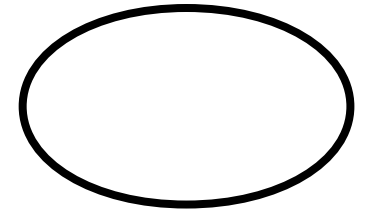
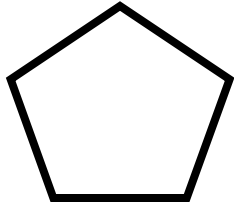

ASSOCIAZIONI LOGICHE

Far associare le immagini secondo un legame logico.

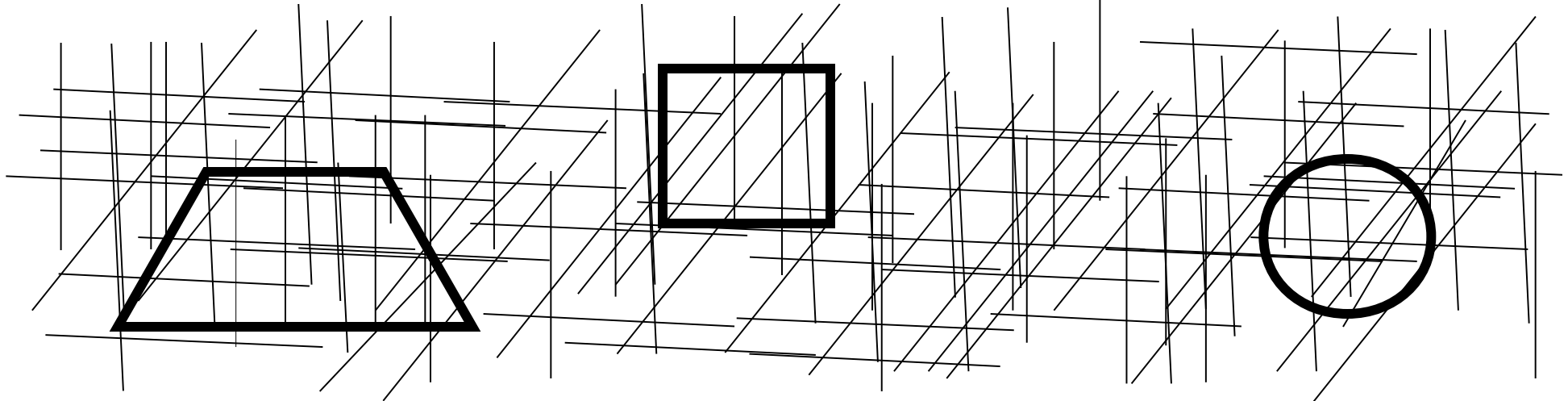
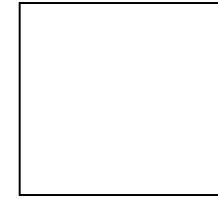
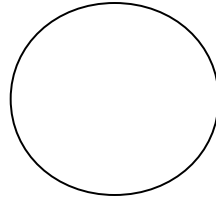
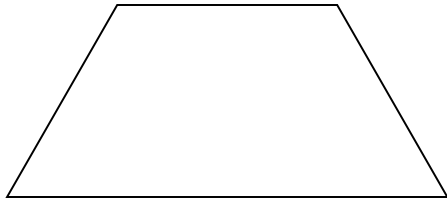

ASSOCIAZIONI LOGICHE

Far associare le immagini secondo un legame logico.

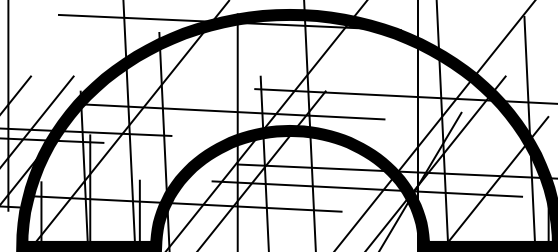
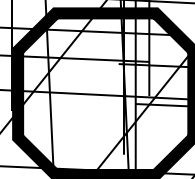
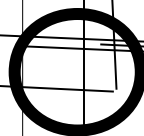
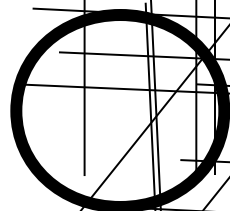
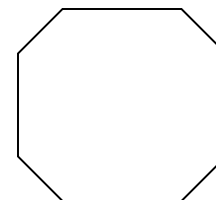
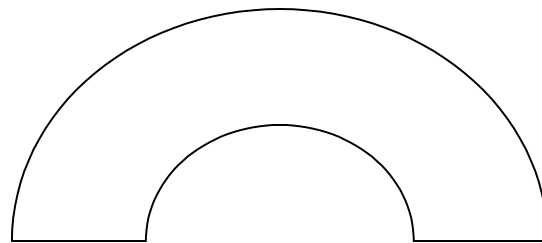
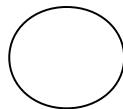
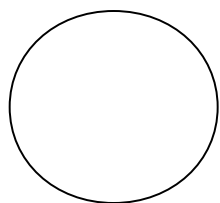

ASSOCIAZIONI LOGICHE

Far associare le immagini secondo un legame logico.

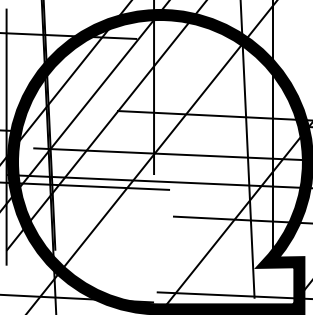
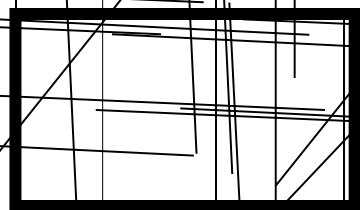
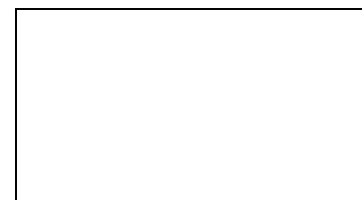
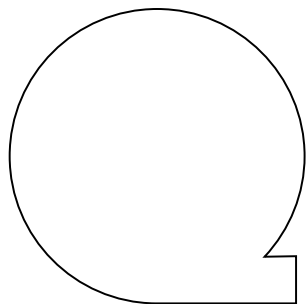

ASSOCIAZIONI LOGICHE

Far associare le immagini secondo un legame logico.

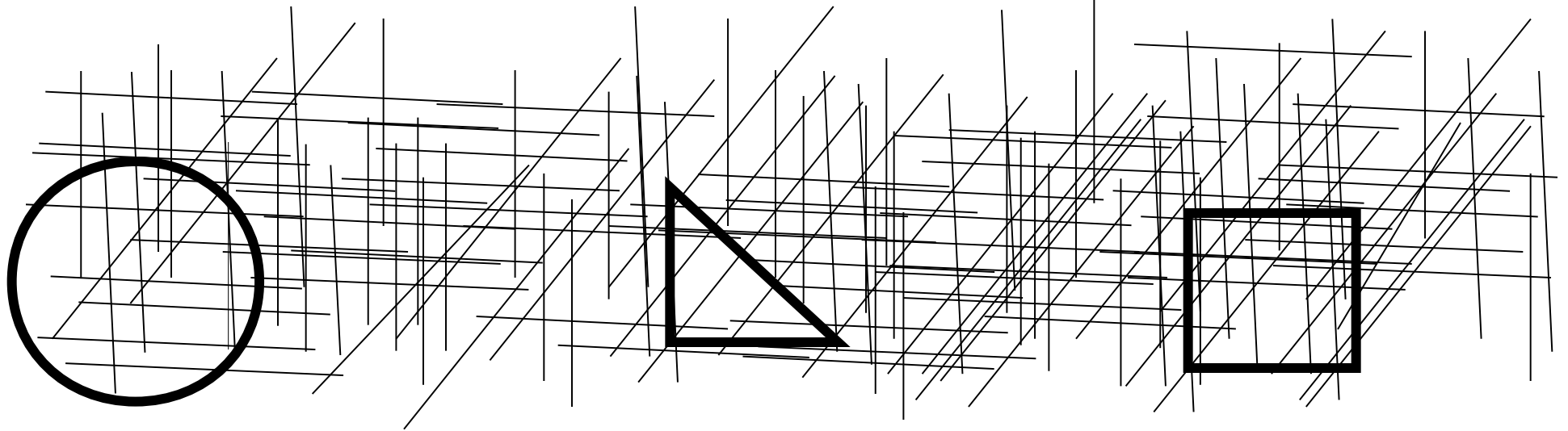
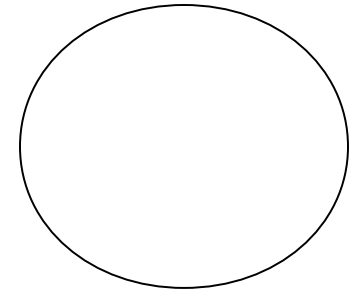
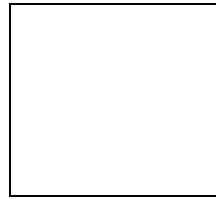
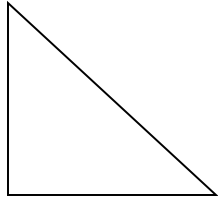

ASSOCIAZIONI LOGICHE

Far associare le immagini secondo un legame logico.

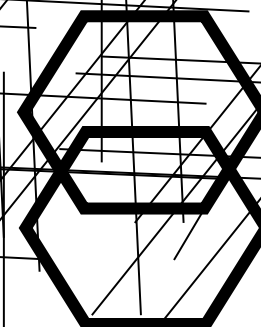
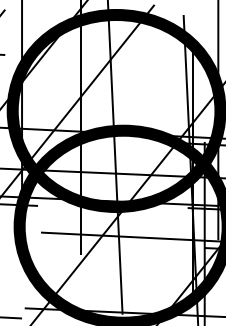
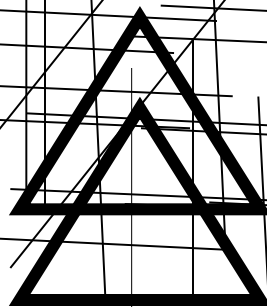
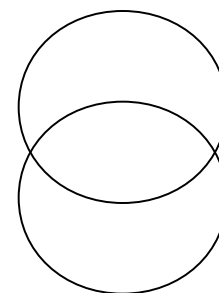
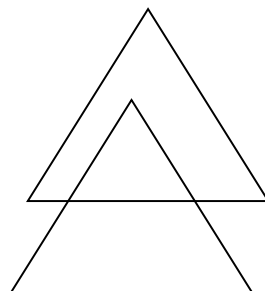
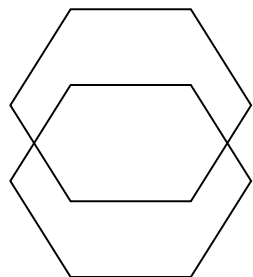

ASSOCIAZIONI LOGICHE

Far associare le immagini secondo un legame logico.

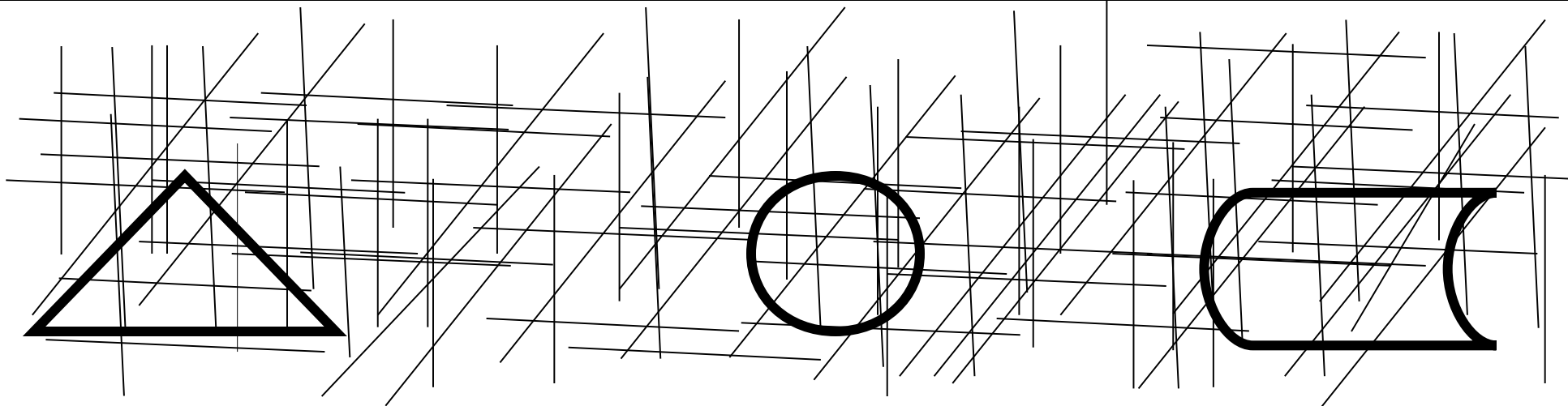
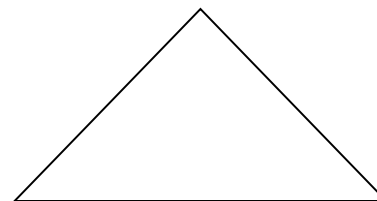
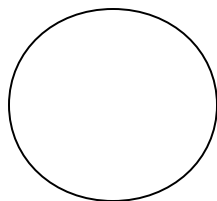
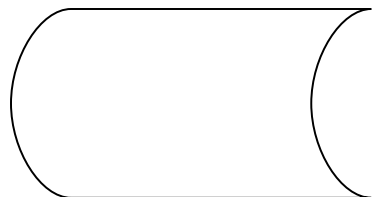

ASSOCIAZIONI LOGICHE

Far associare le immagini secondo un legame logico.

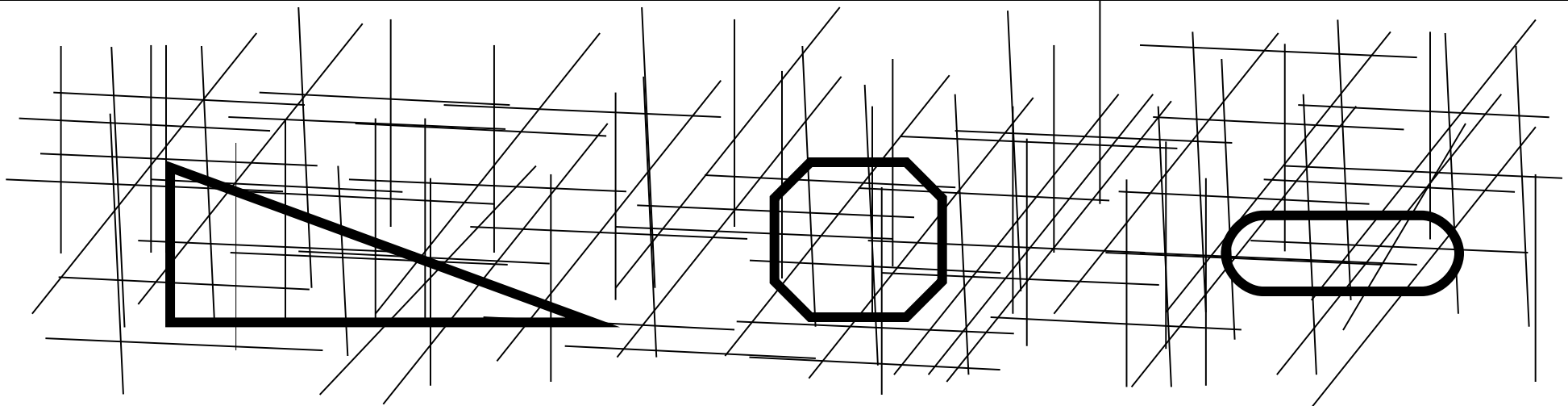
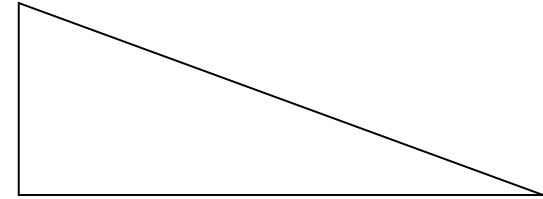
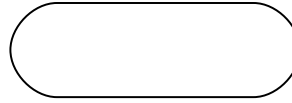
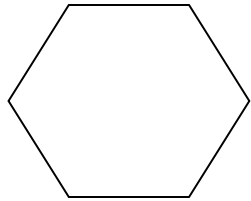

ASSOCIAZIONI LOGICHE

Far associare le immagini secondo un legame logico.

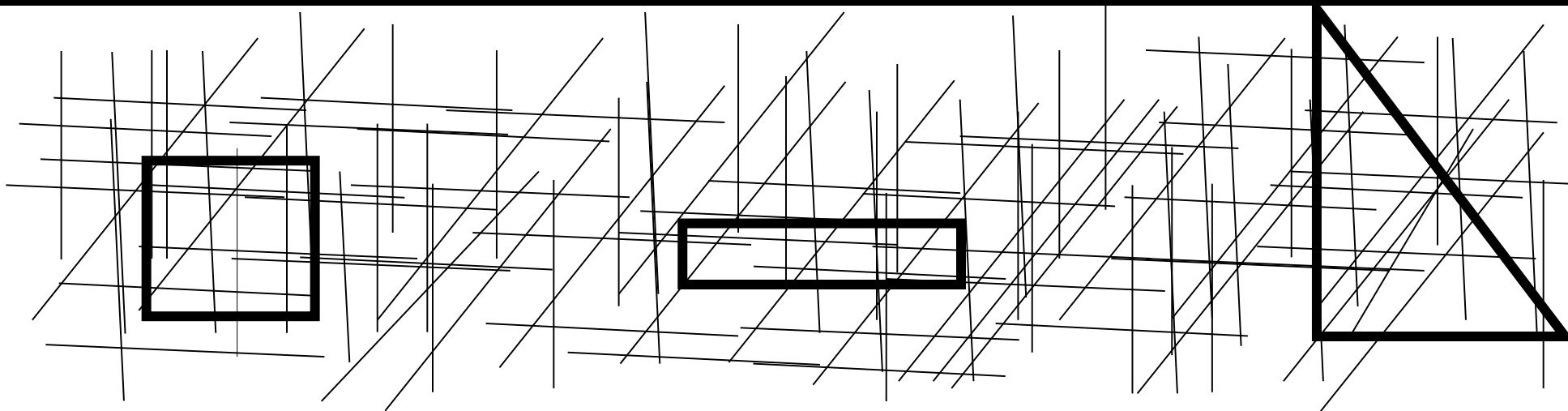
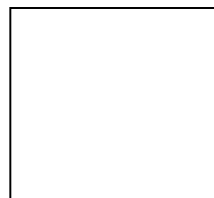
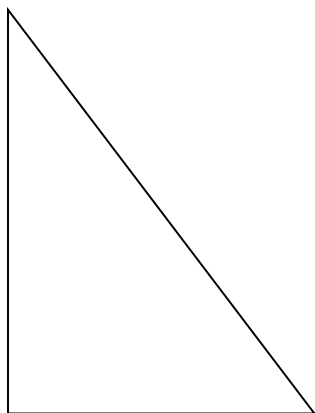

ASSOCIAZIONI LOGICHE

Far associare le immagini secondo un legame logico.

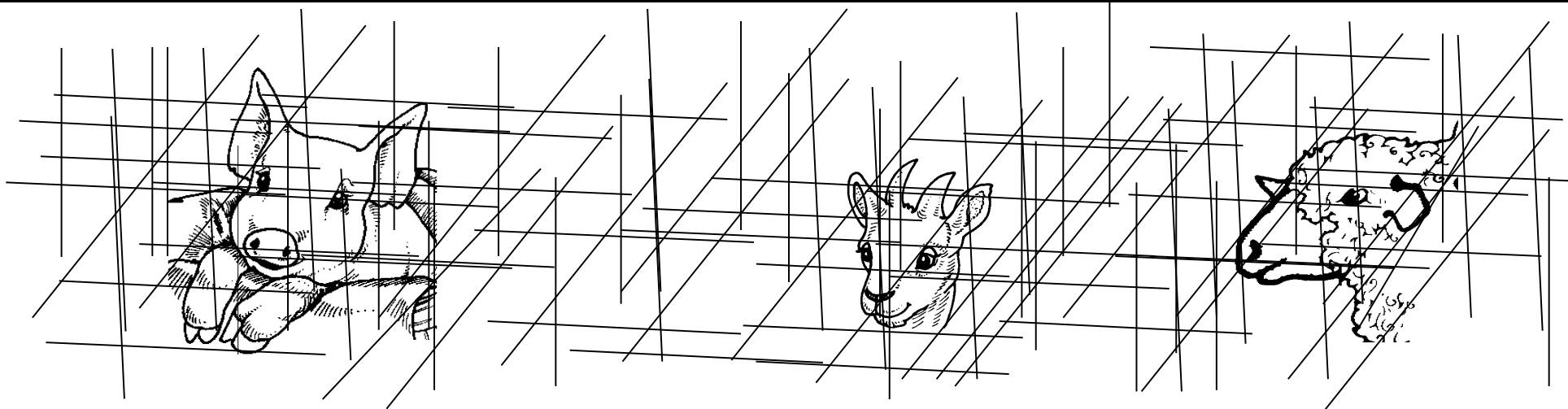
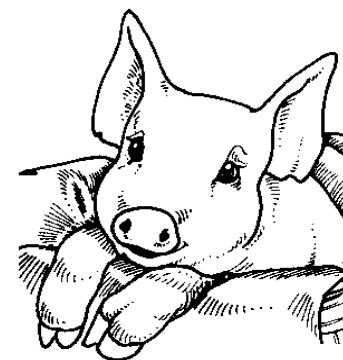

ASSOCIAZIONI LOGICHE

Far associare le immagini secondo un legame logico.



ASSOCIAZIONI LOGICHE

Far associare le immagini secondo un legame logico.

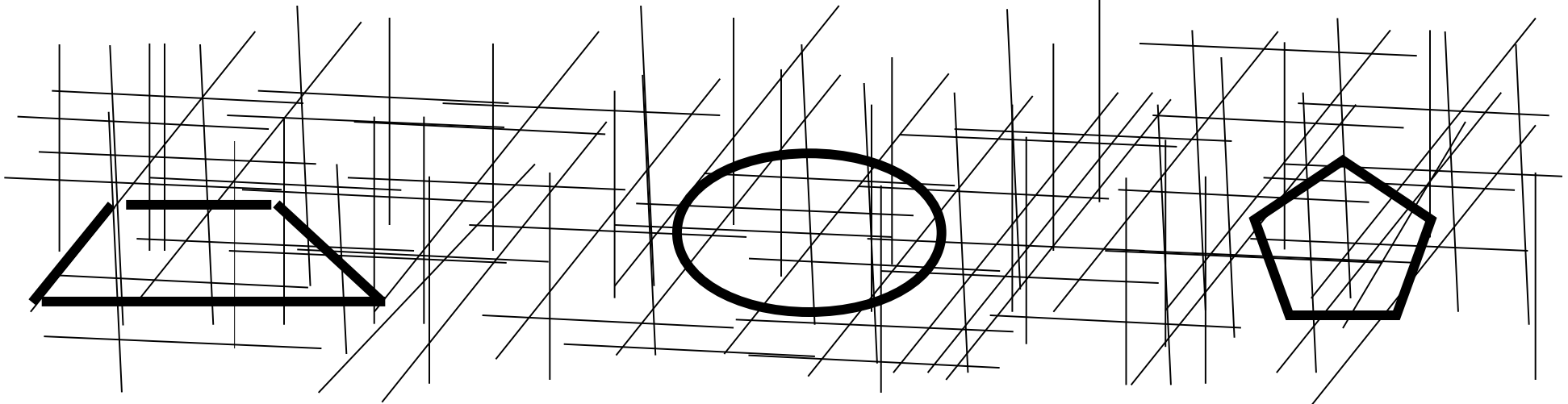
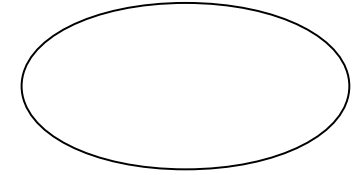
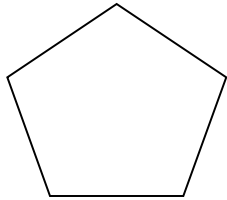

ASSOCIAZIONI LOGICHE

Far associare le immagini secondo un legame logico.

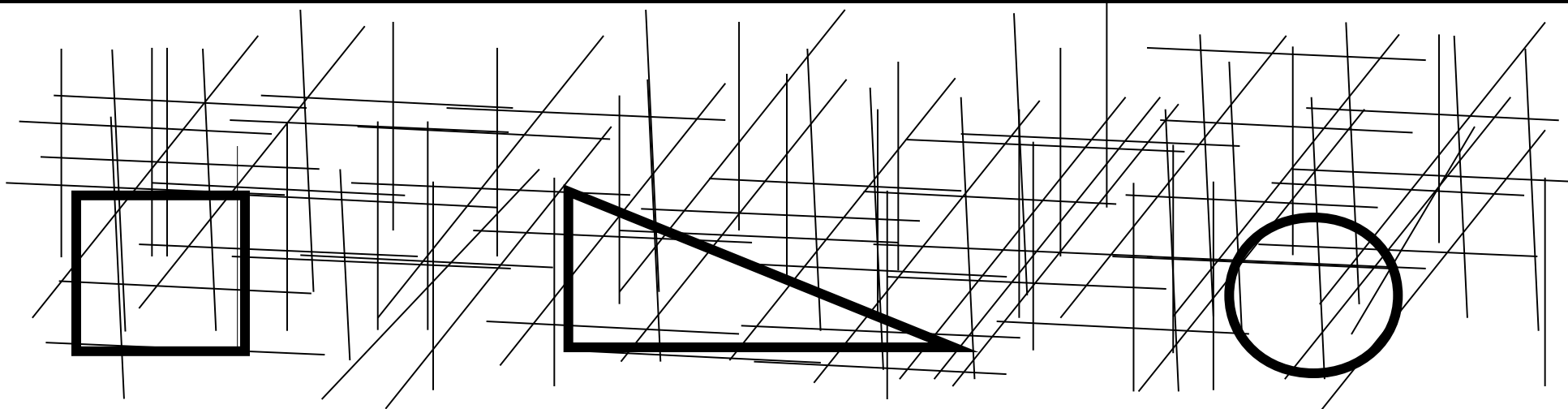
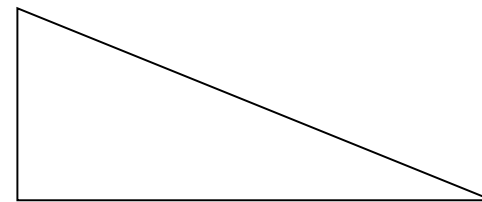
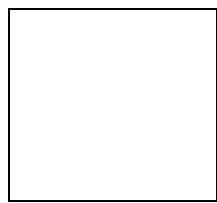
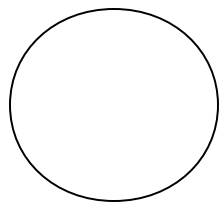

ASSOCIAZIONI LOGICHE

Far associare le immagini secondo un legame logico.

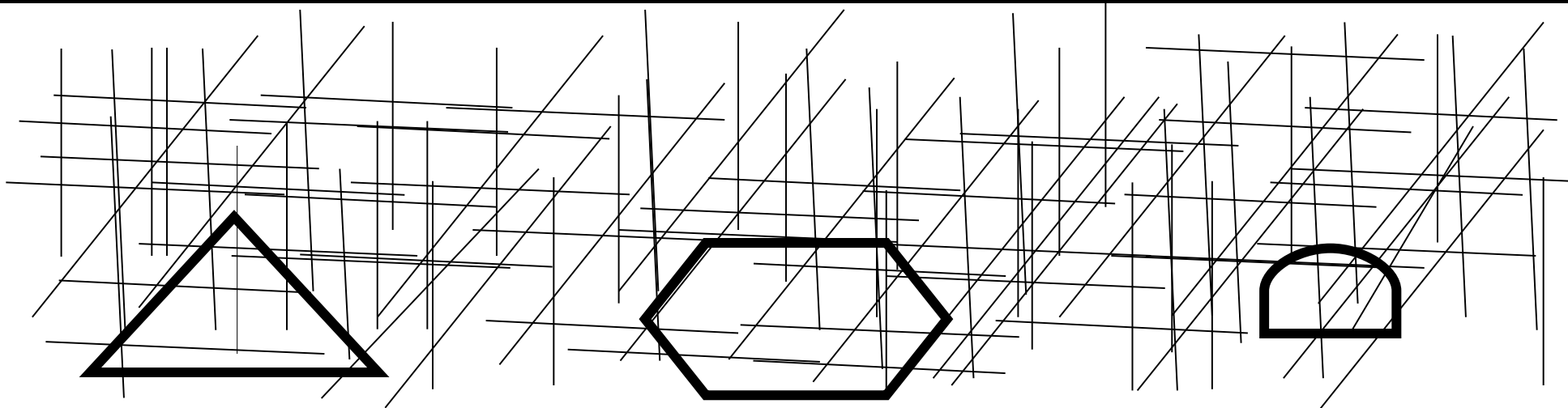
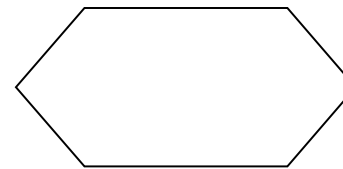
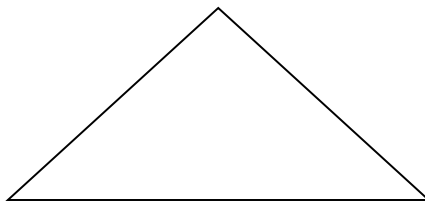
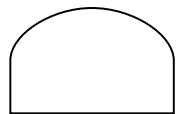

ASSOCIAZIONI LOGICHE

Far associare le immagini secondo un legame logico.

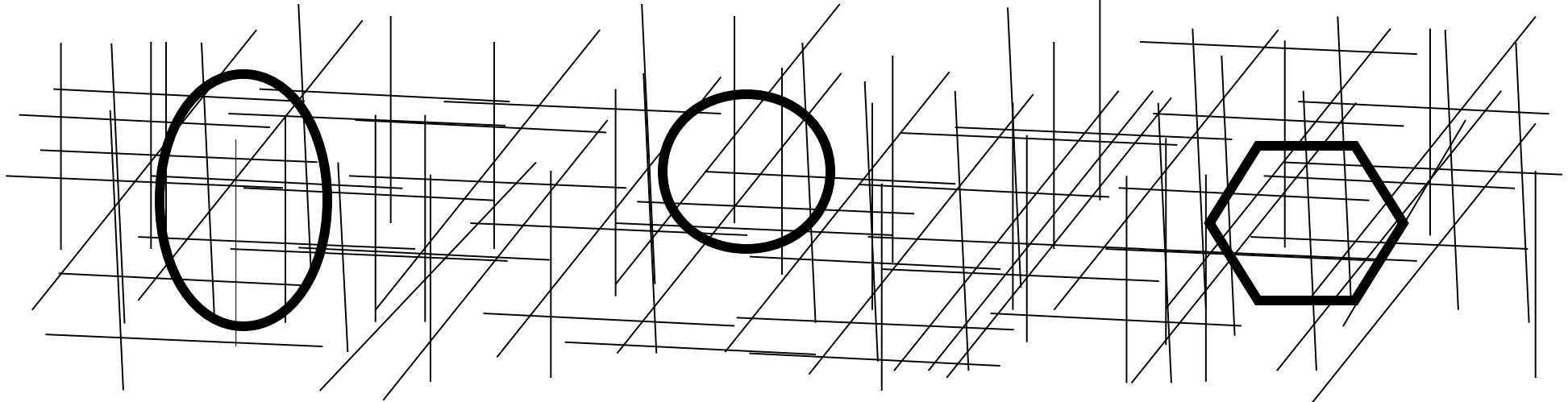
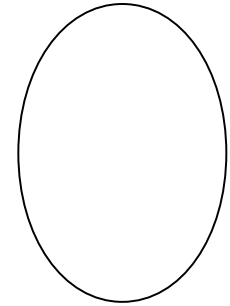
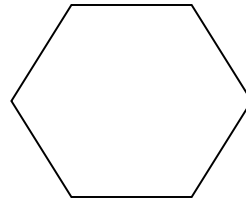
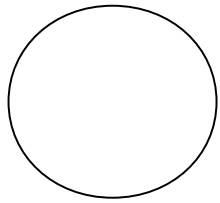

ASSOCIAZIONI LOGICHE

Far associare le immagini secondo un legame logico.

ASSOCIAZIONI LOGICHE

L'attività di associare un oggetto, un animale, un vegetale o una forma geometrica ad un altro, ricercando un possibile legame logico di uso, funzione, forma, posizione nello spazio, somiglianza, causa - effetto, parte - tutto ecc. implica la stimolazione di processi di astrazione, classificazione ed organizzazione spaziale, basilari per lo sviluppo intellettuale.

UTILIZZAZIONE

Per utilizzare tali schede basta indicare al bambino l'immagine presente nella parte alta della scheda, chiedendo di associarla con un'altra disegnata nella parte bassa. Nei bambini sordi, si cercherà di utilizzare il segno mimico che significa legame. Dopo che il bambino avrà effettuato l'associazione l'educatore chiarirà il motivo che lo ha spinto ad effettuare tale scelta.

VERBALIZZAZIONE

1^a Fase

Inizialmente per questa attività chiederemo al bambino solo il nome degli oggetti che si associano.

2^a Fase.

In un secondo momento, sarà il bambino stesso ad esplicitare il motivo che lo ha spinto ad effettuare quell'associazione.

ETA' DI RIFERIMENTO

Quattro anni nello sviluppo logico.

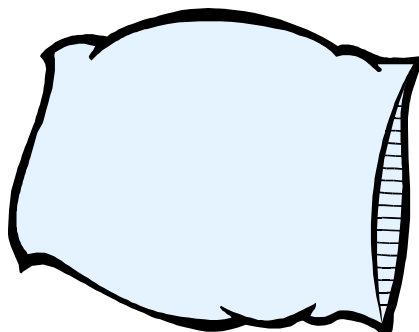
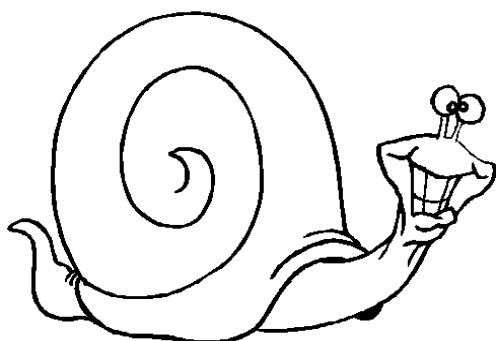
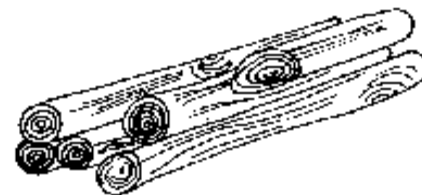
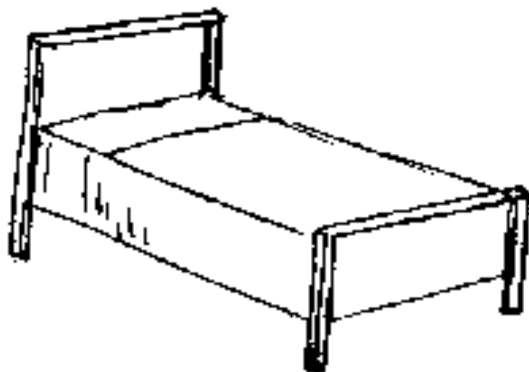
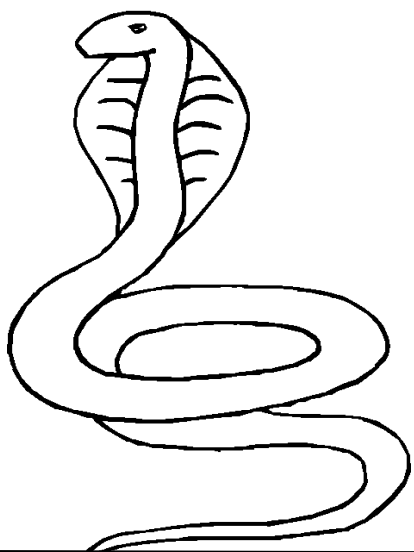

ASSOCIAZIONI LOGICHE

Far denominare e associare le immagini secondo un legame logico.

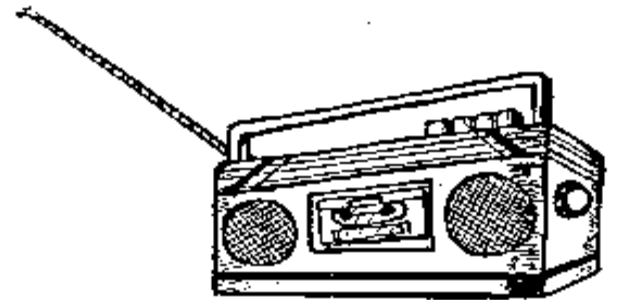
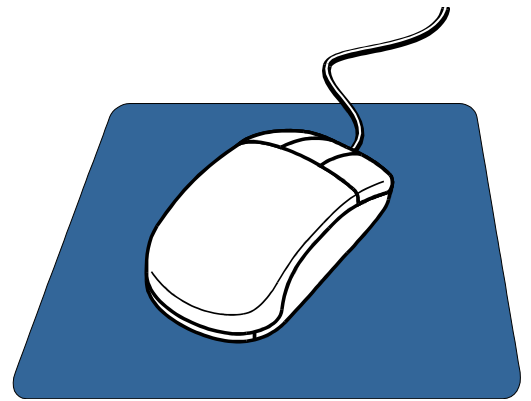
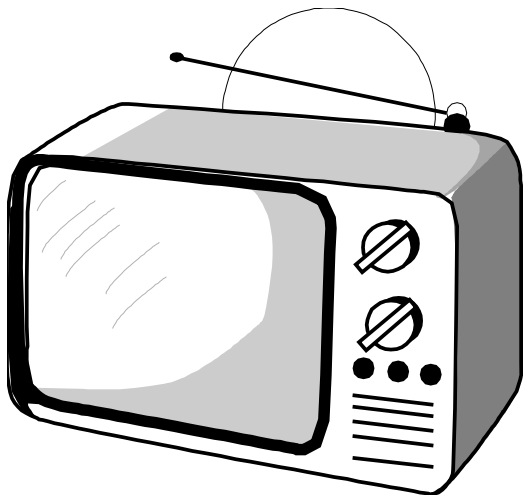

ASSOCIAZIONI LOGICHE

Far denominare e associare le immagini secondo un legame logico.

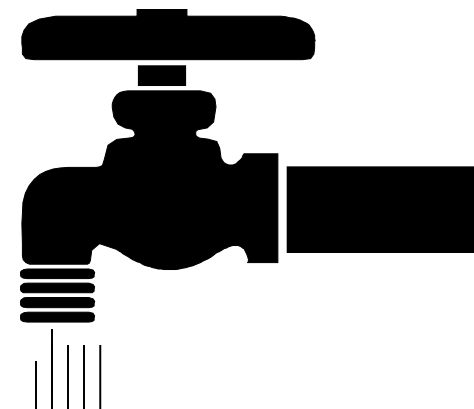
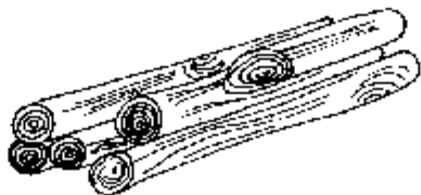

ASSOCIAZIONI LOGICHE

Far denominare e associare le immagini secondo un legame logico.

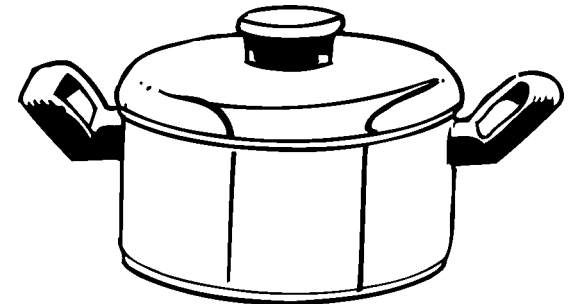
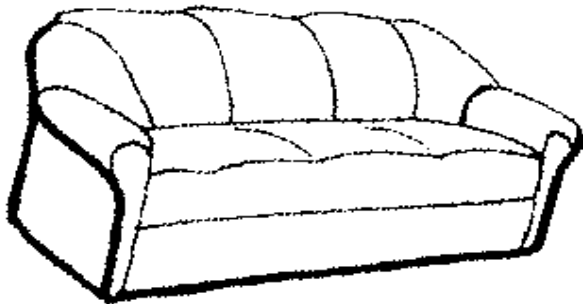
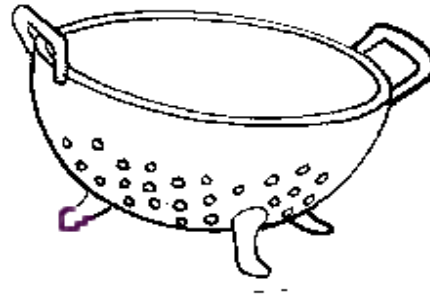
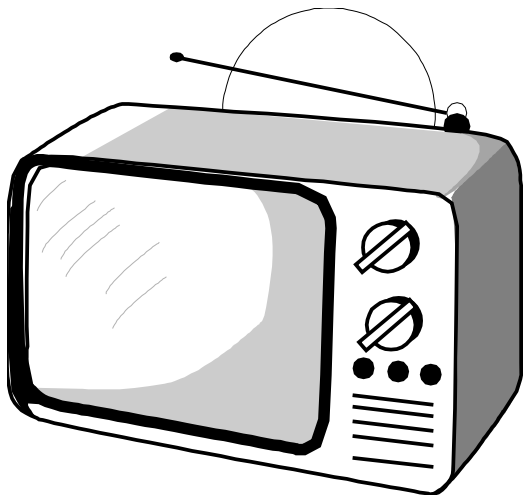

ASSOCIAZIONI LOGICHE

Far denominare e associare le immagini secondo un legame logico.

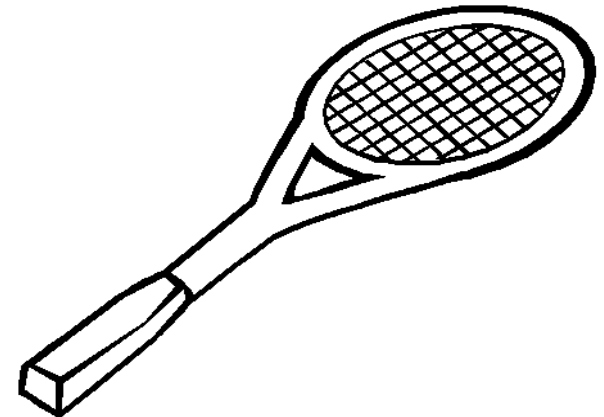
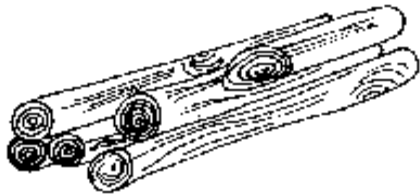
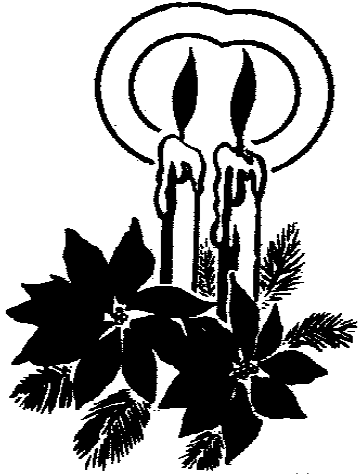

ASSOCIAZIONI LOGICHE

Far denominare e associare le immagini secondo un legame logico.

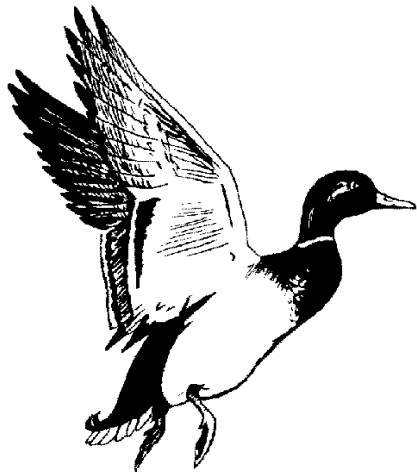
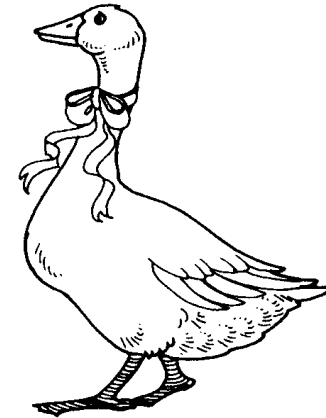
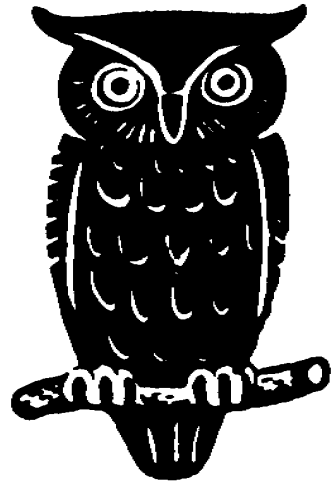

ASSOCIAZIONI LOGICHE

Far denominare e associare le immagini secondo un legame logico.

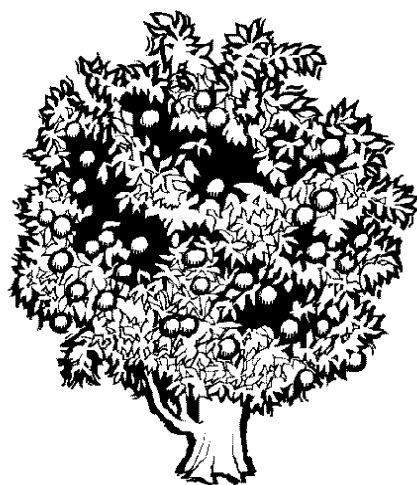

ASSOCIAZIONI LOGICHE

Far denominare e associare le immagini secondo un legame logico.

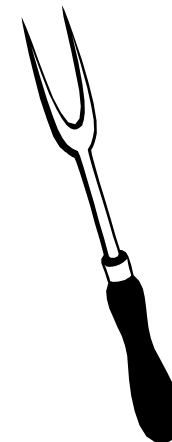
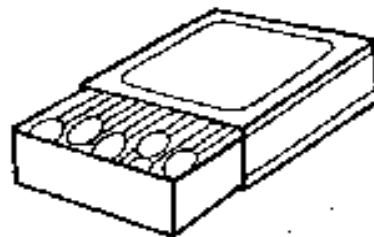
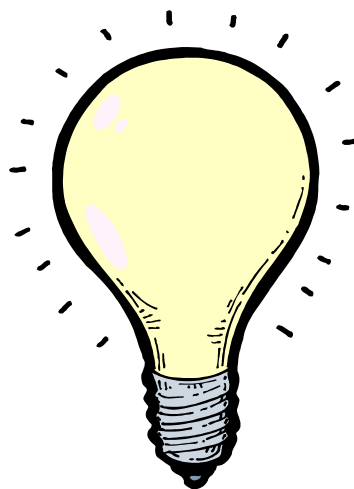
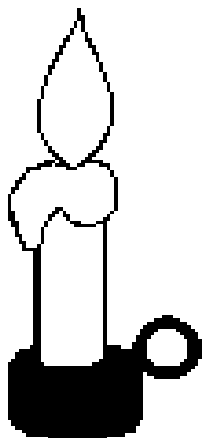

ASSOCIAZIONI LOGICHE

Far denominare e associare le immagini secondo un legame logico.

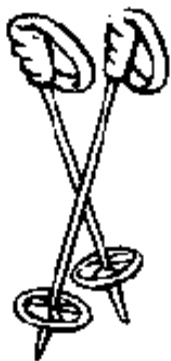
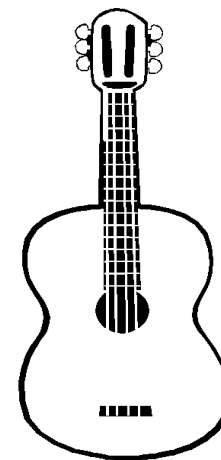
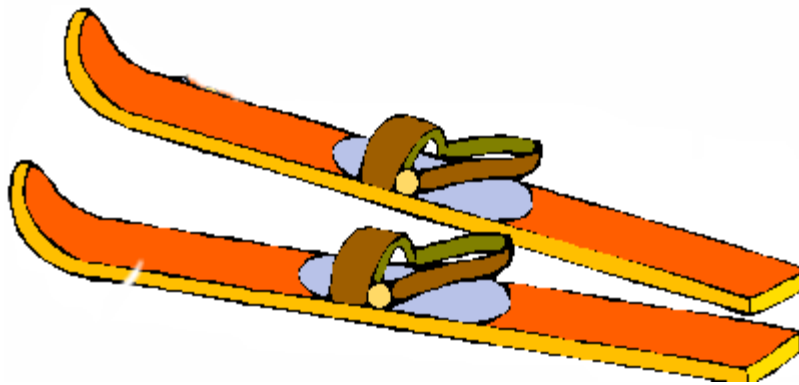
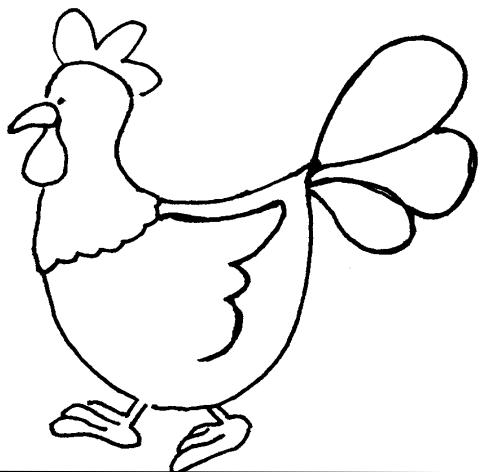

ASSOCIAZIONI LOGICHE

Far denominare e associare le immagini secondo un legame logico.

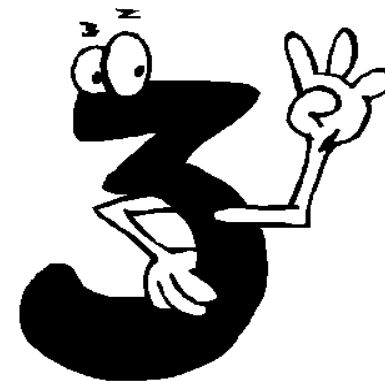
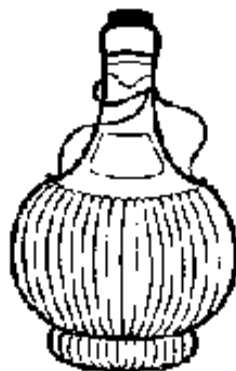
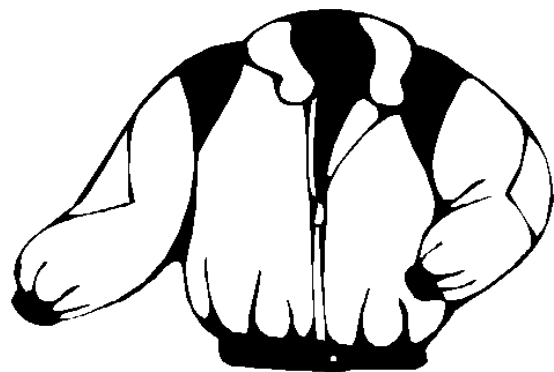
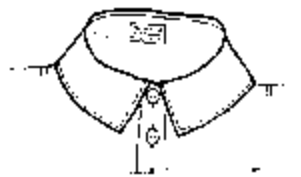

ASSOCIAZIONI LOGICHE

Far denominare e associare le immagini secondo un legame logico.

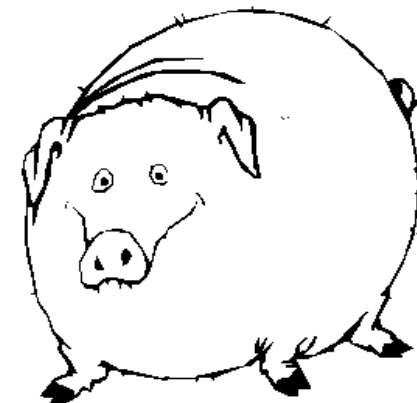
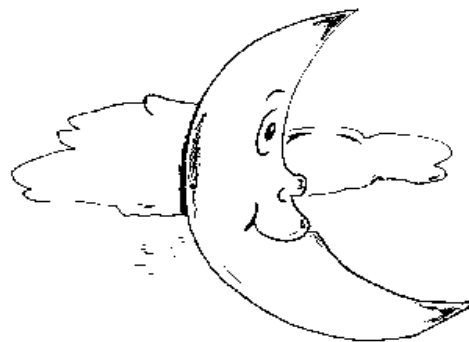
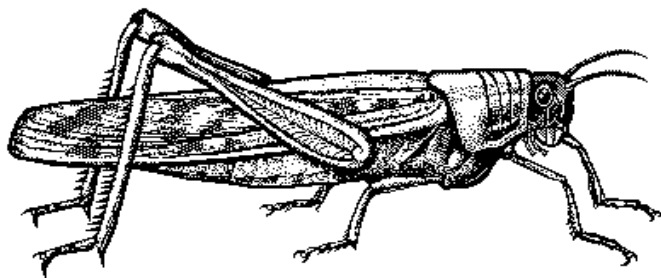
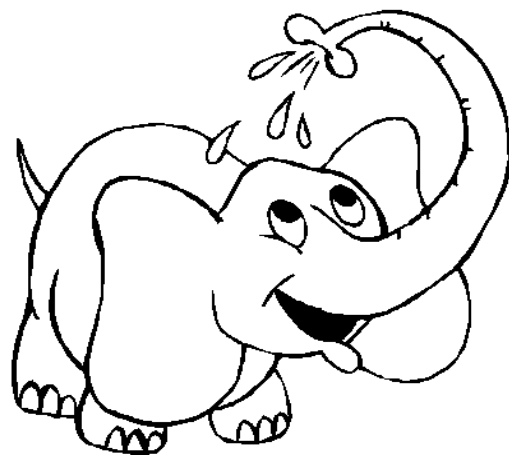
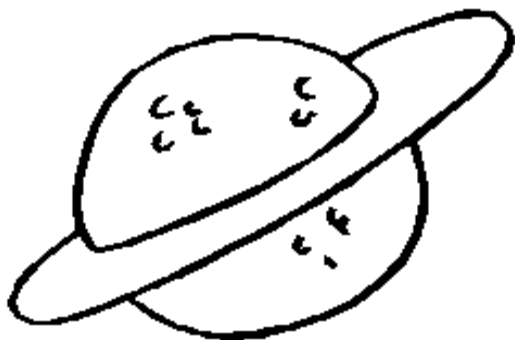

ASSOCIAZIONI LOGICHE

Far denominare e associare le immagini secondo un legame logico.

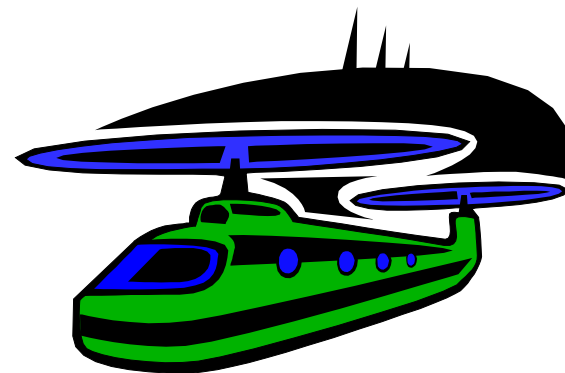
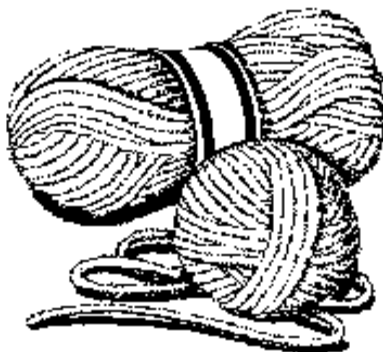
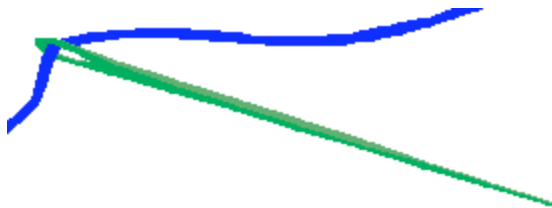
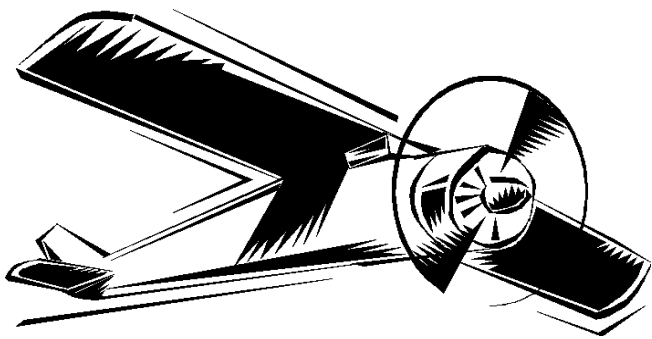

ASSOCIAZIONI LOGICHE

Far denominare e associare le immagini secondo un legame logico.

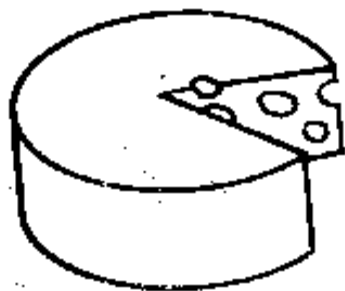
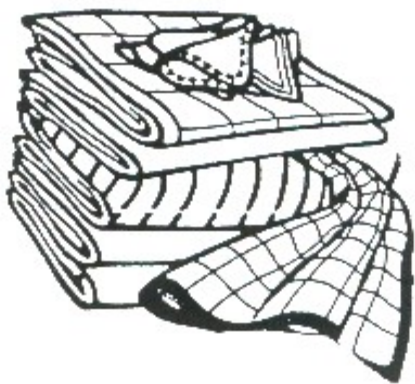

ASSOCIAZIONI LOGICHE

Far denominare e associare le immagini secondo un legame logico.

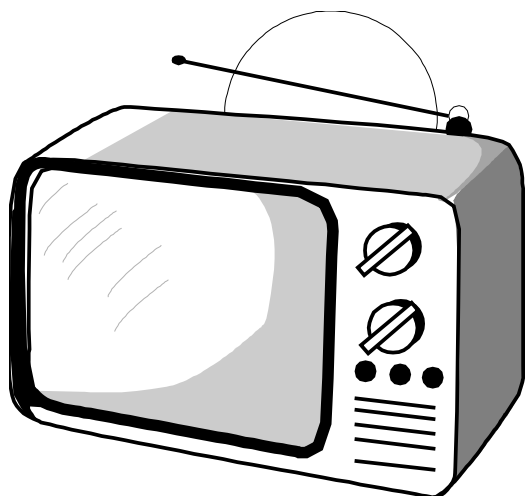
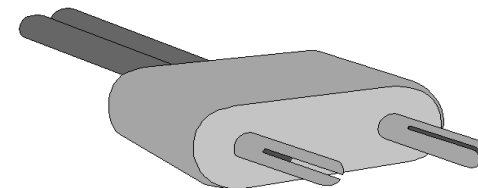

ASSOCIAZIONI LOGICHE

Far denominare e associare le immagini secondo un legame logico.

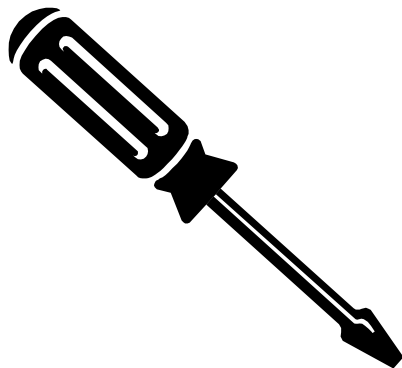
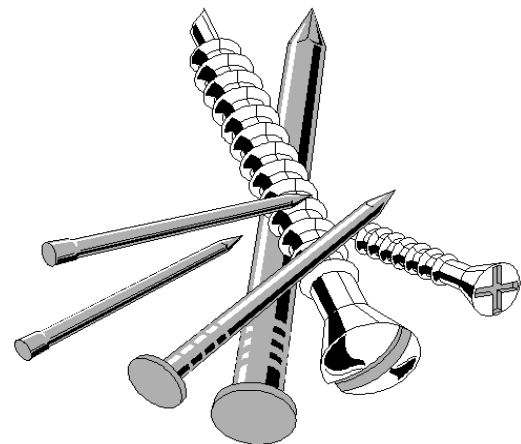

ASSOCIAZIONI LOGICHE

Far denominare e associare le immagini secondo un legame logico.

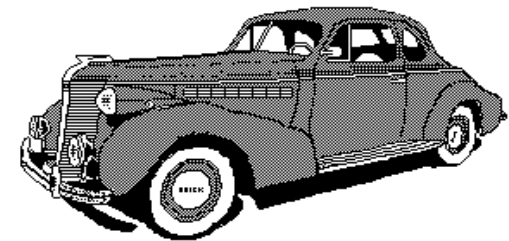
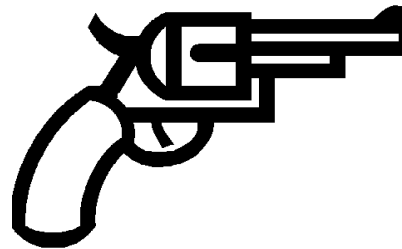
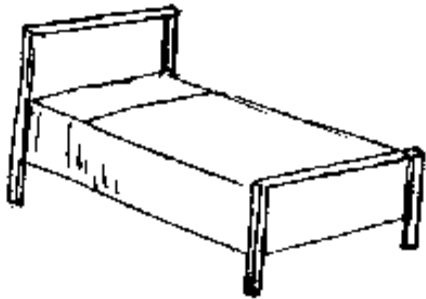
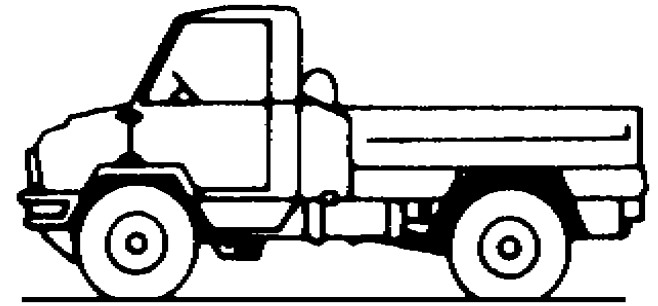
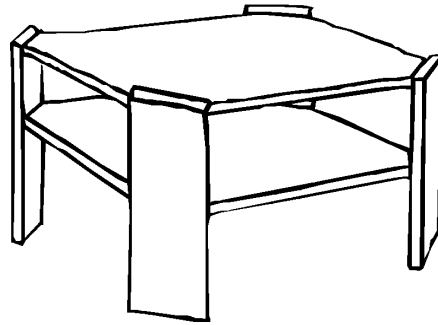
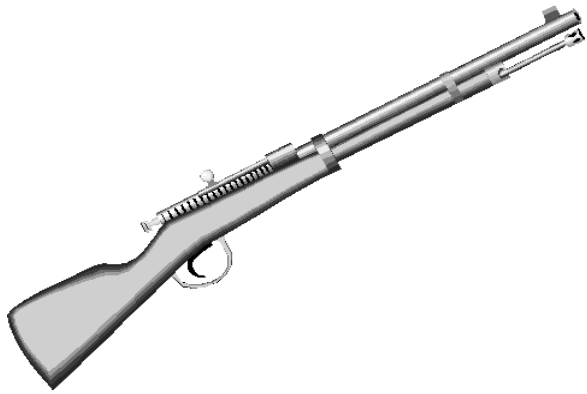

ASSOCIAZIONI LOGICHE

Far denominare e associare le immagini secondo un legame logico.

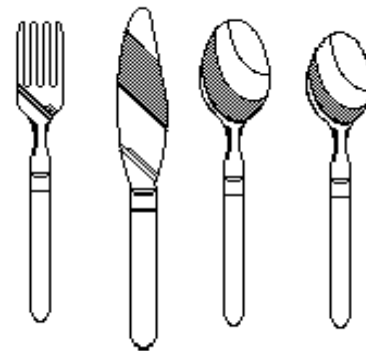
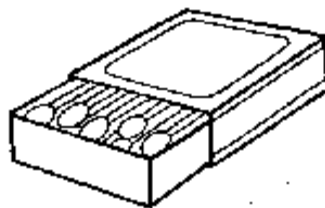
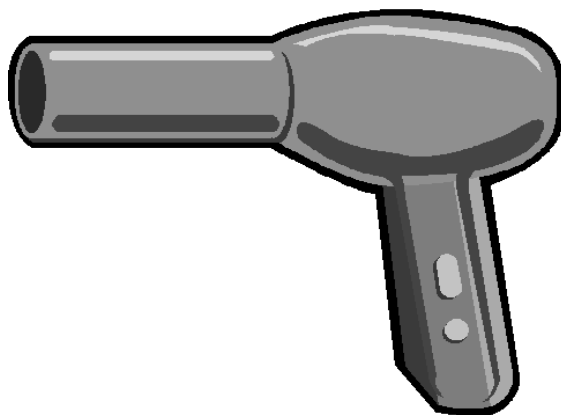
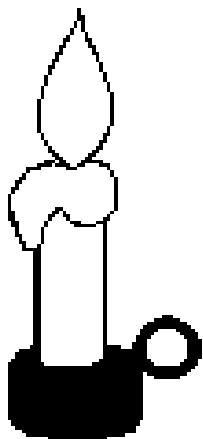

ASSOCIAZIONI LOGICHE

Far denominare e associare le immagini secondo un legame logico.

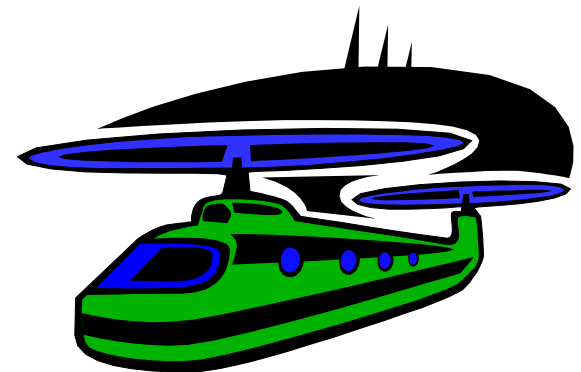
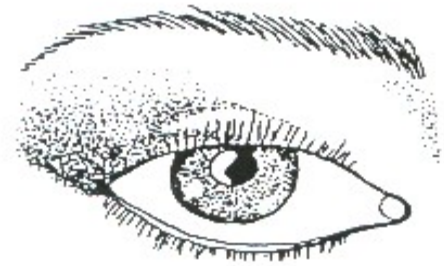
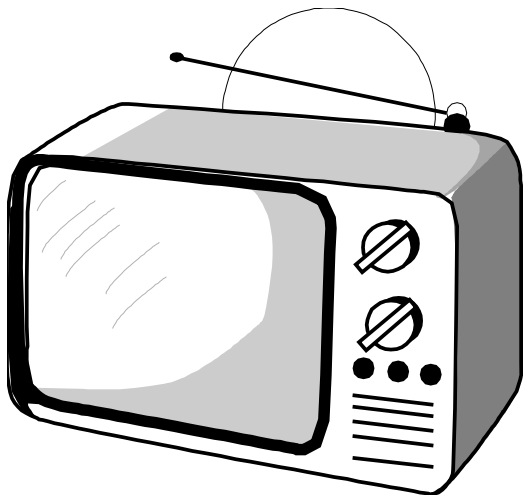

ASSOCIAZIONI LOGICHE

Far denominare e associare le immagini secondo un legame logico.

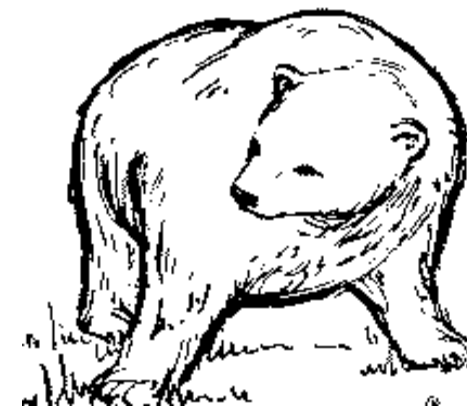
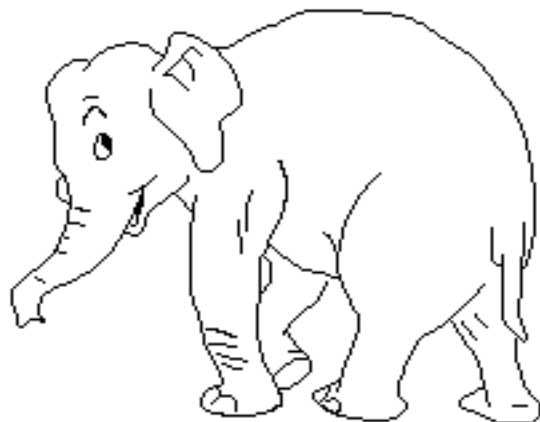
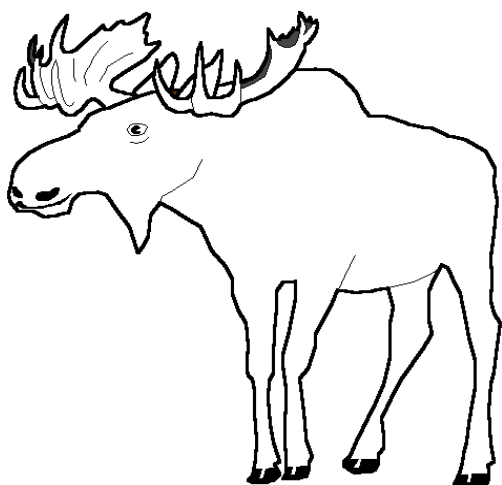
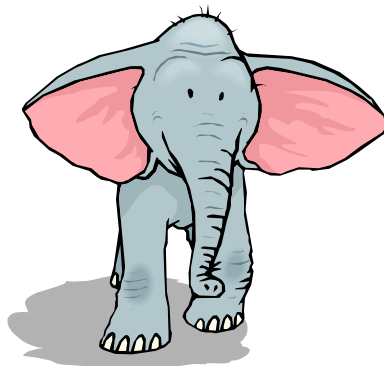

ASSOCIAZIONI LOGICHE

Far denominare e associare le immagini secondo un legame logico.

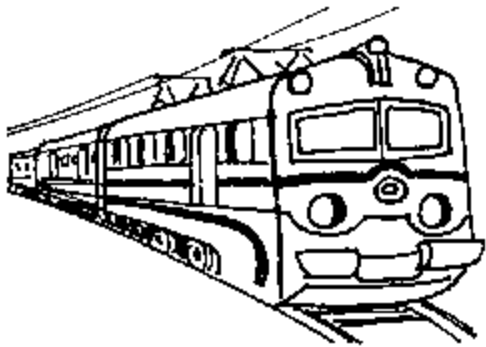
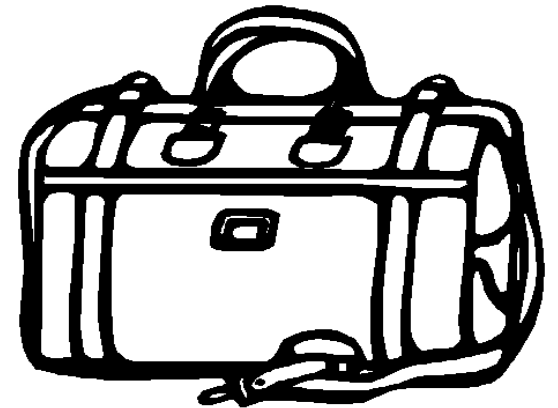
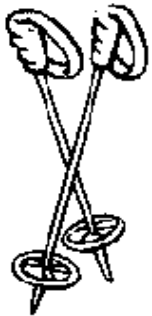

ASSOCIAZIONI LOGICHE

Far denominare e associare le immagini secondo un legame logico.

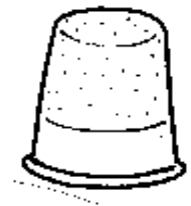
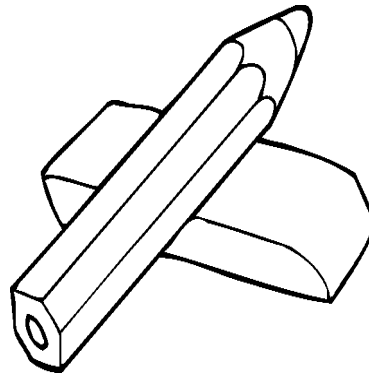
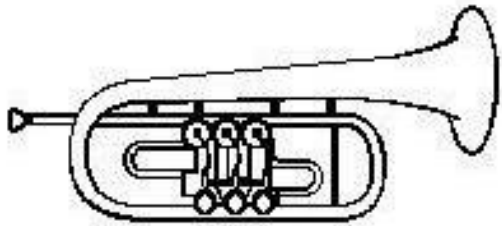
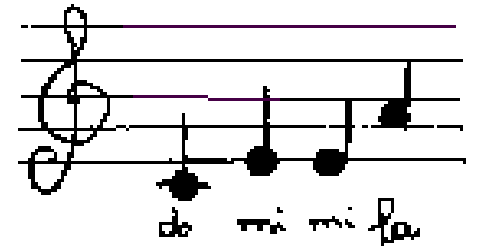
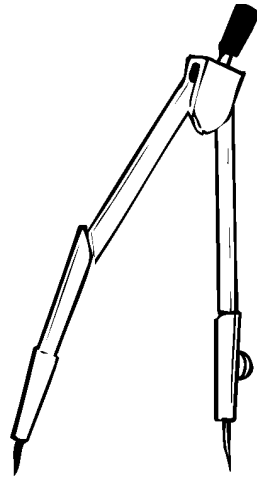

ASSOCIAZIONI LOGICHE

Far denominare e associare le immagini secondo un legame logico.

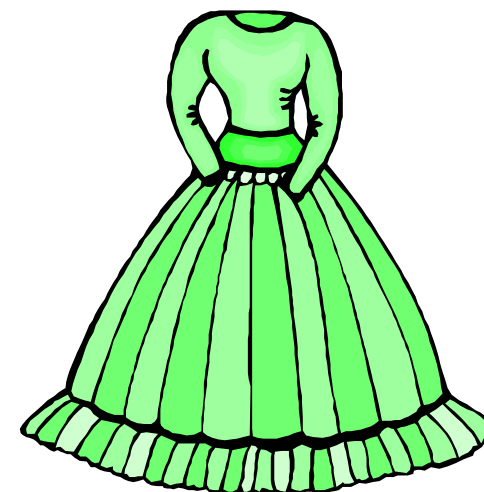
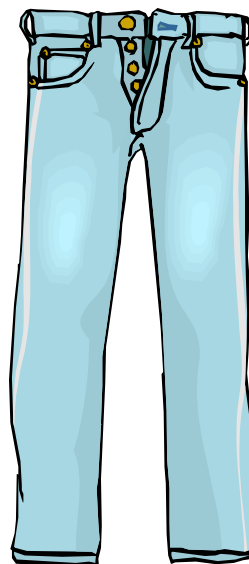
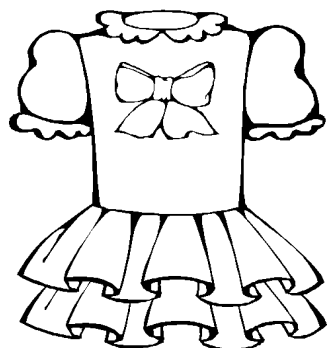
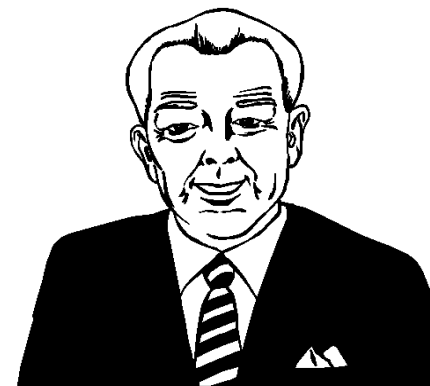

ASSOCIAZIONI LOGICHE

Far denominare e associare le immagini secondo un legame logico.

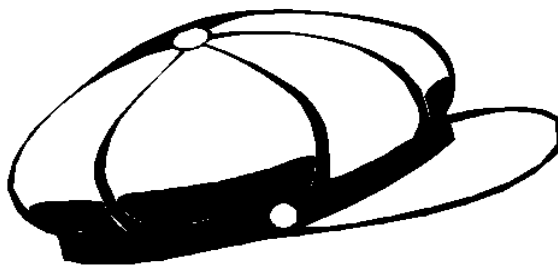
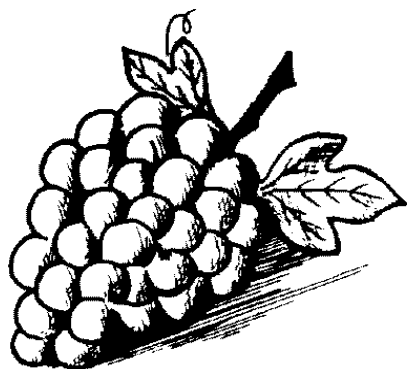
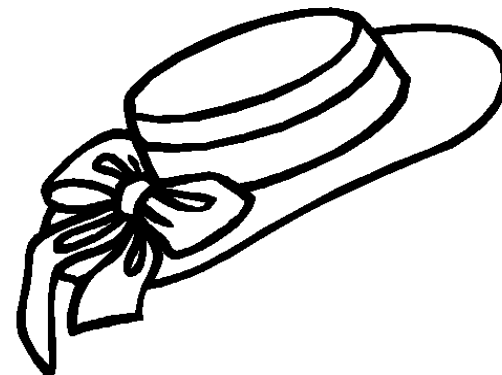

ASSOCIAZIONI LOGICHE

Far denominare e associare le immagini secondo un legame logico.

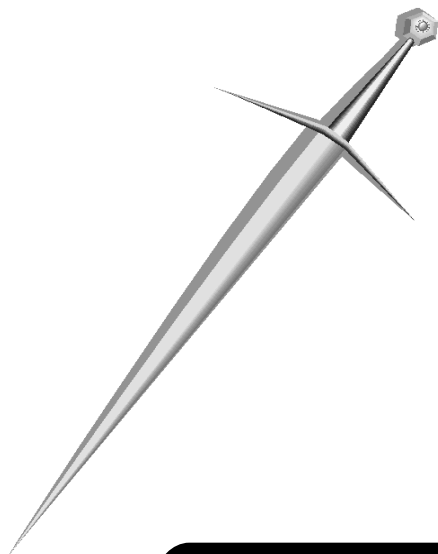
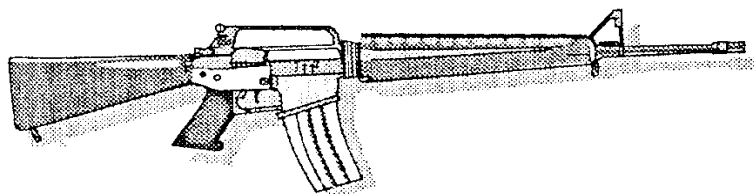

ASSOCIAZIONI LOGICHE

Far denominare e associare le immagini secondo un legame logico.

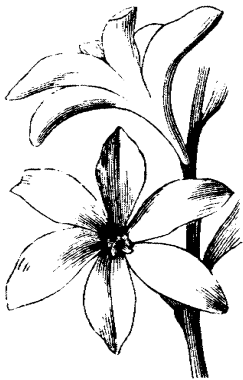

ASSOCIAZIONI LOGICHE

Far denominare e associare le immagini secondo un legame logico.

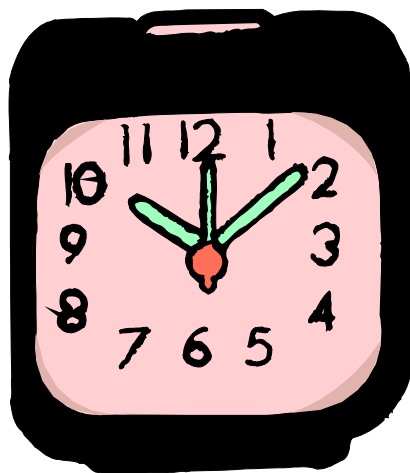
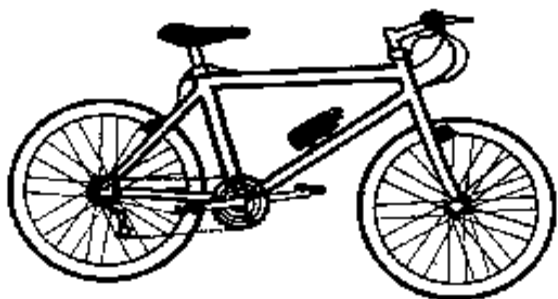
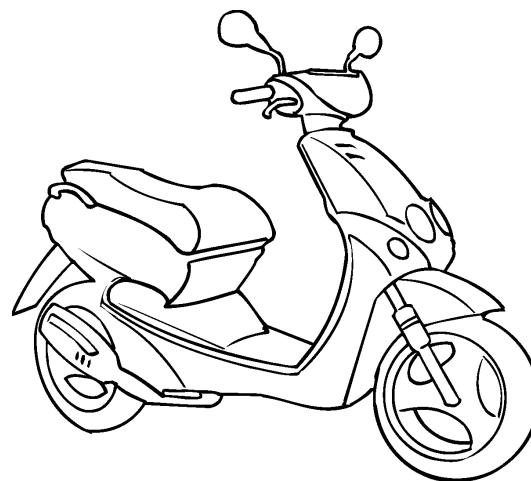
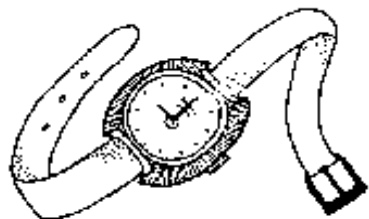

ASSOCIAZIONI LOGICHE

Far denominare e associare le immagini secondo un legame logico.

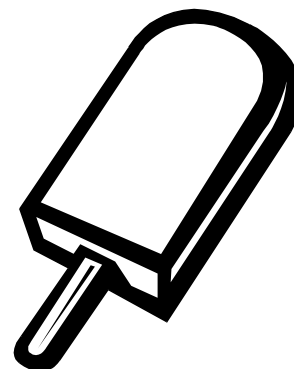
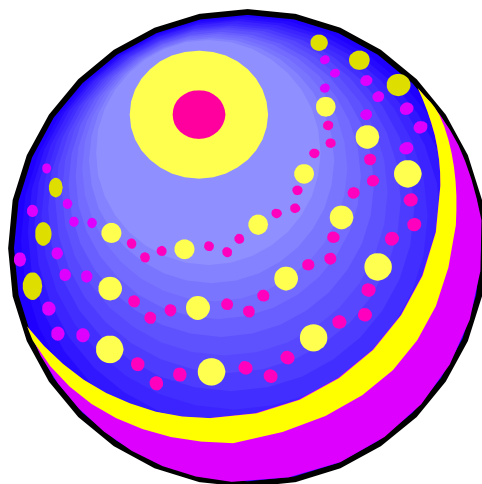
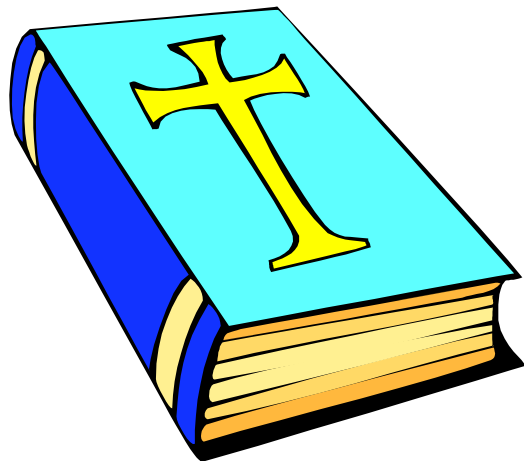
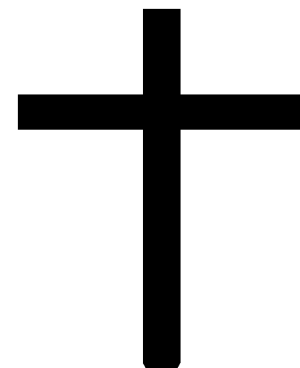
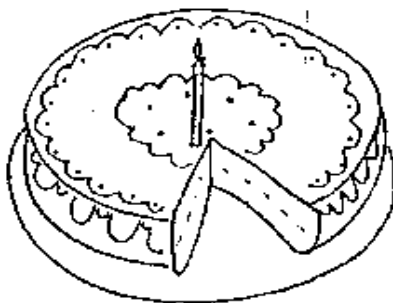

ASSOCIAZIONI LOGICHE

Far denominare e associare le immagini secondo un legame logico.

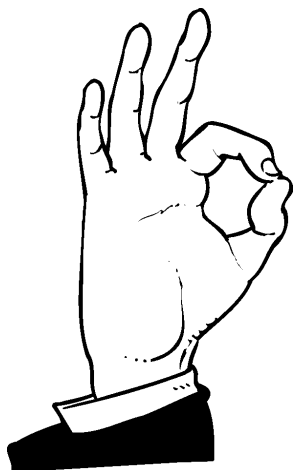

ASSOCIAZIONI LOGICHE

Far denominare e associare le immagini secondo un legame logico.

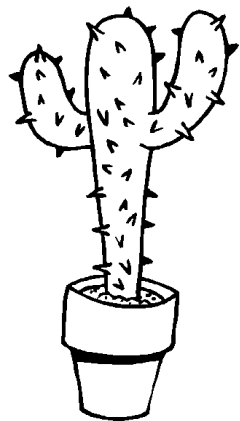
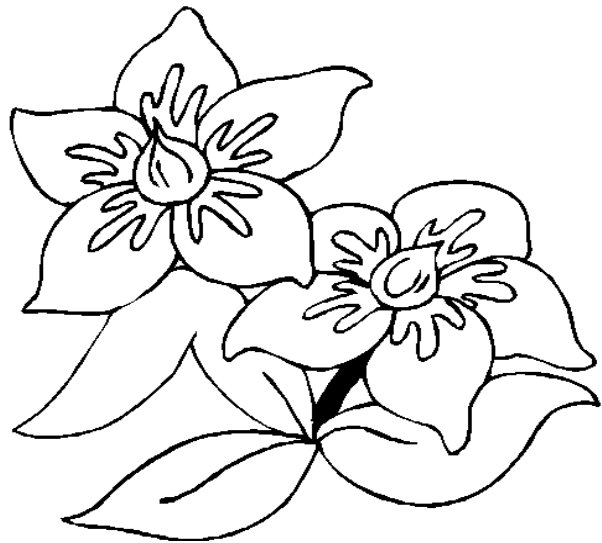

ASSOCIAZIONI LOGICHE

Far denominare e associare le immagini secondo un legame logico.

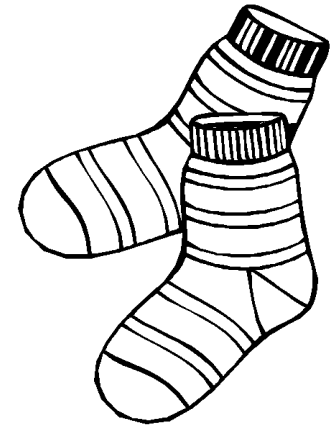
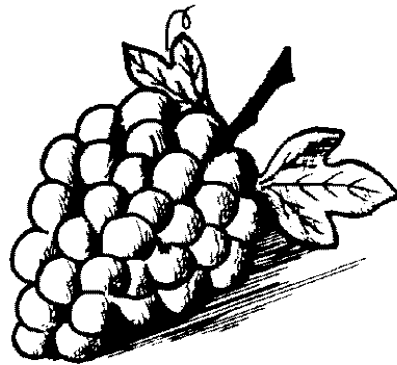
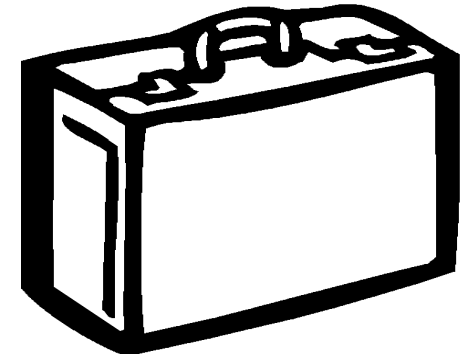
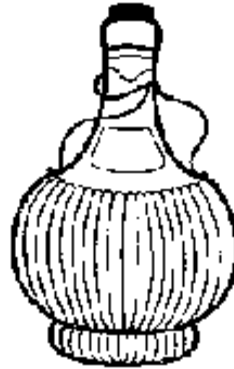
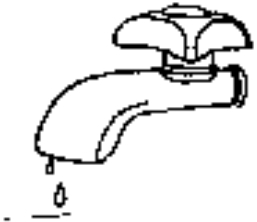

ASSOCIAZIONI LOGICHE

Far denominare e associare le immagini secondo un legame logico.

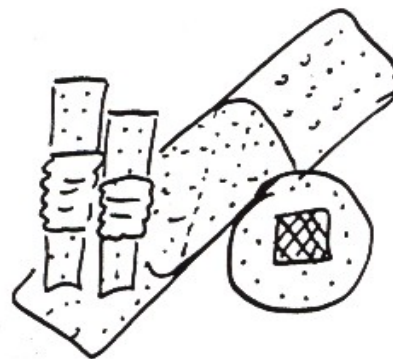
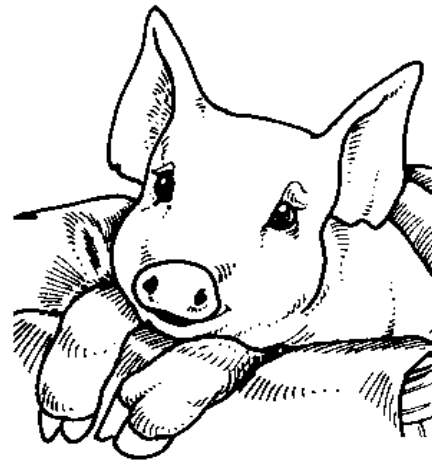
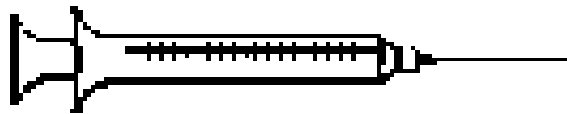

ASSOCIAZIONI LOGICHE

Far denominare e associare le immagini secondo un legame logico.

ASSOCIAZIONI DI IMMAGINI UGUALI O SIMILI

La possibilità di stimolazione logica fino ai tre anni, in pratica coincide per lo più con la possibilità dello sviluppo psicomotorio, percettivo e del linguaggio.

Il bambino, infatti, manifesta le sue capacità logiche attraverso un'attività rivolta soprattutto all'analisi, confronto e interpretazione della realtà sensoriale.

Nella sua esplorazione del mondo vengono ad essere coinvolti tutti i sensi per cui è importante una molteplicità di stimolazioni.

Maggiore attenzione noi diamo alla percezione uditiva e visiva, in quanto è più facile, per gli studiosi e per gli educatori in genere, preparare e somministrare materiale graduato e opportunamente variato composto da immagini, da suoni e parole, piuttosto che da gusti e da odori.

Le schede che qui presentiamo sono formate da immagini uguali o simili da riconoscere e da associare che hanno lo scopo di sviluppare nel bambino non solo la percezione visiva ma anche il linguaggio, i primi processi di astrazione e i fondamentali rapporti spaziali.

Il bambino viene inoltre arricchito da numerosi elementi culturali.

In tali schede sono presenti delle immagini nella parte alta da associare con quelle corrispondenti nella parte bassa.

UTILIZZAZIONE

Per un corretto uso di tali schede è opportuno seguire due fasi:

I fase

Inizialmente l'educatore dirà il nome dell'immagine di cui chiede l'associazione, ed è sufficiente in questa prima frase che il bambino risponda con un semplice gesto della mano.

Nel caso di bambini molto piccoli o inibiti l'educatore potrà tenere con la sua la mano del bambino in modo tale da incoraggiarlo e avviarlo al gioco associativo.

II fase

Gradualmente sarà il bambino stesso a verbalizzare il nome delle immagini più semplici mentre effettuerà l'associazione.

ETA' MENTALE DI RIFERIMENTO

Quattro anni.

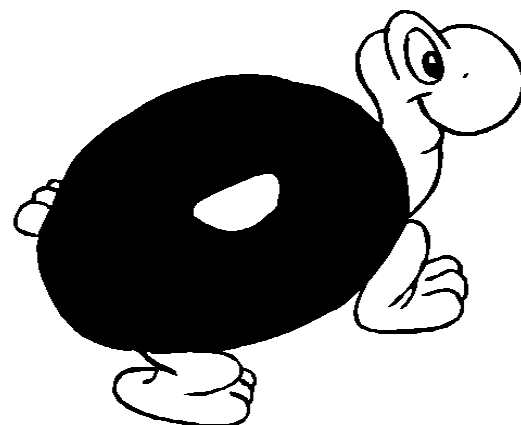
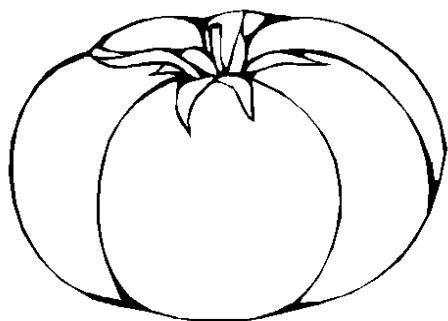
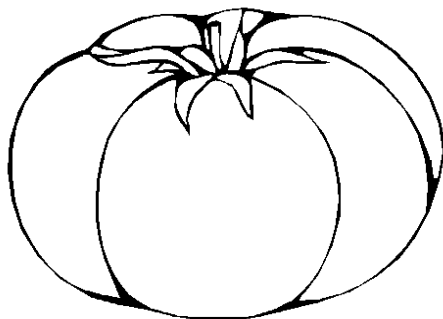
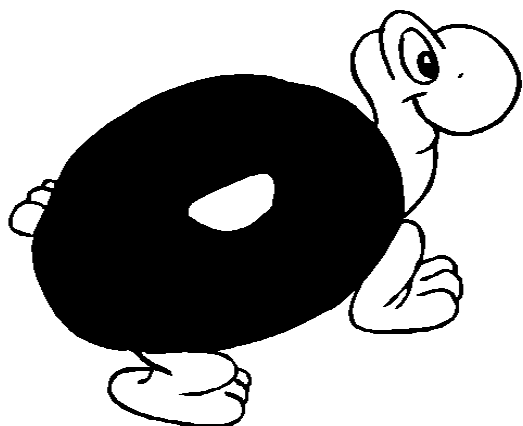

ASSOCIAZIONI DI IMMAGINI UGUALI O SIMILI
Far denominare e associare le immagini uguali o simili.

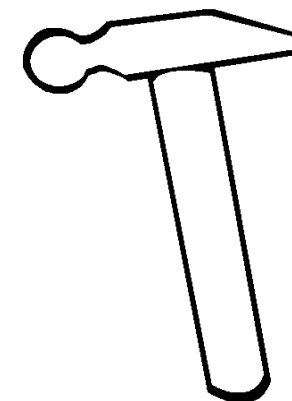
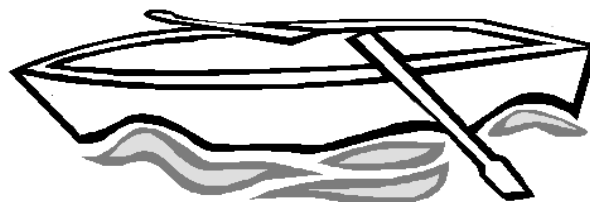
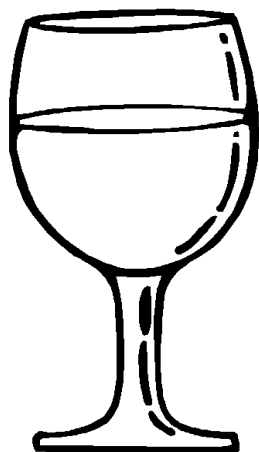
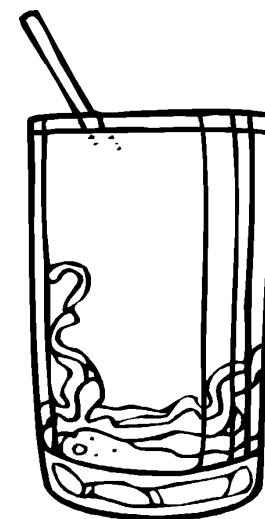
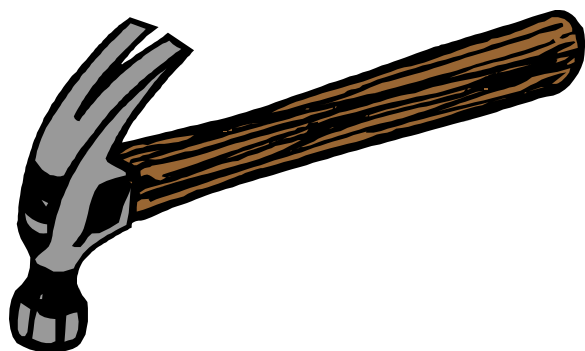

ASSOCIAZIONI DI IMMAGINI UGUALI O SIMILI
Far denominare e associare le immagini uguali o simili.

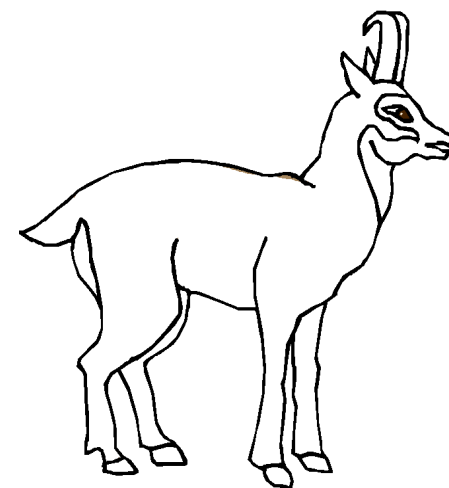
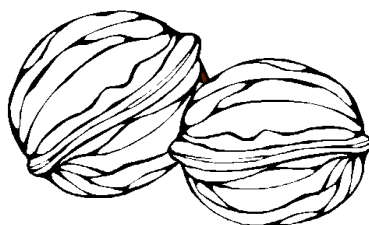
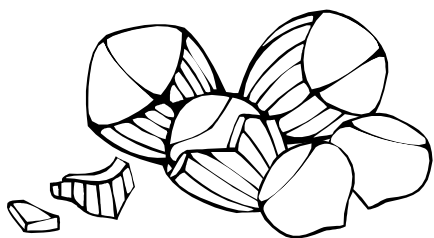
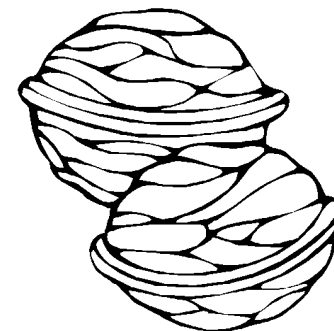
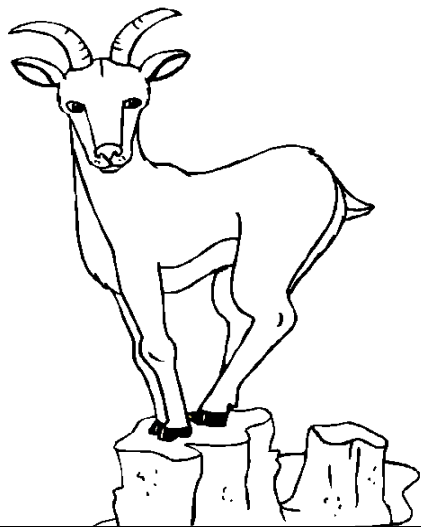

ASSOCIAZIONI DI IMMAGINI UGUALI O SIMILI
Far denominare e associare le immagini uguali o simili.

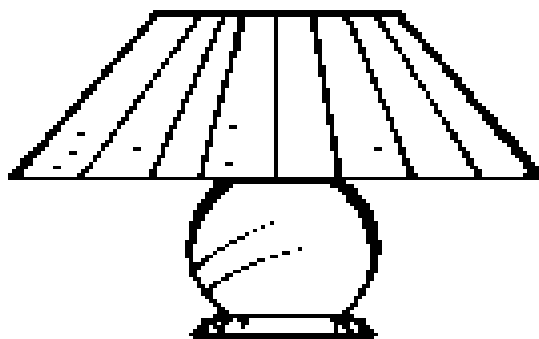
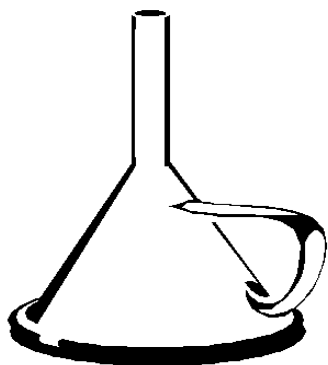
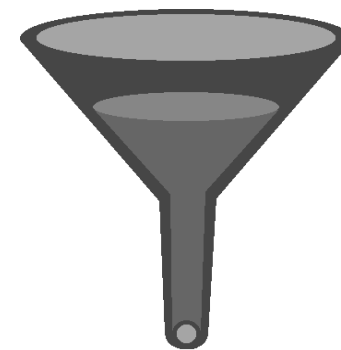
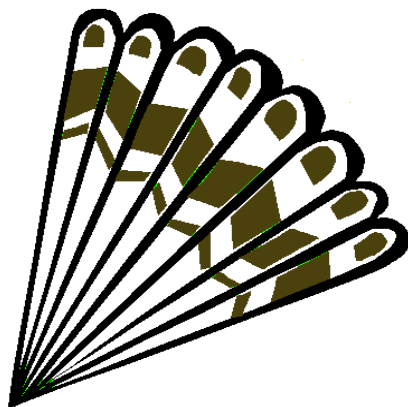
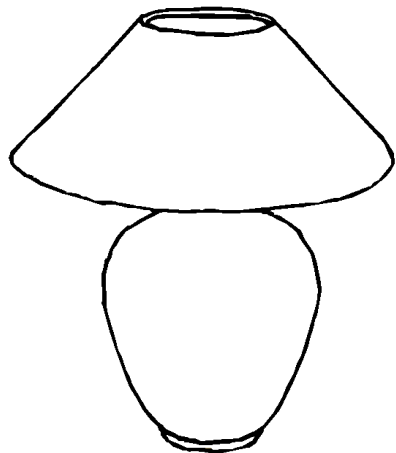

ASSOCIAZIONI DI IMMAGINI UGUALI O SIMILI
Far denominare e associare le immagini uguali o simili.

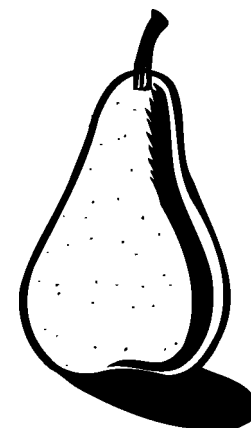
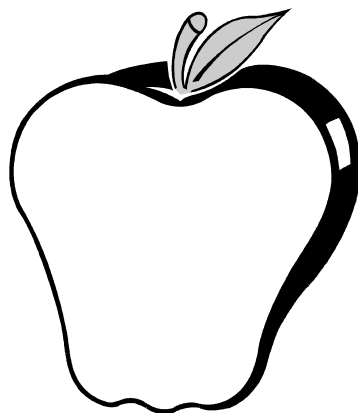
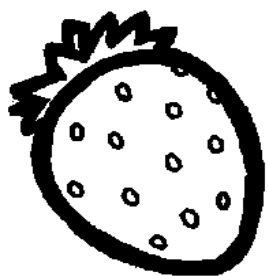
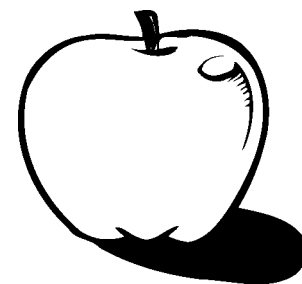
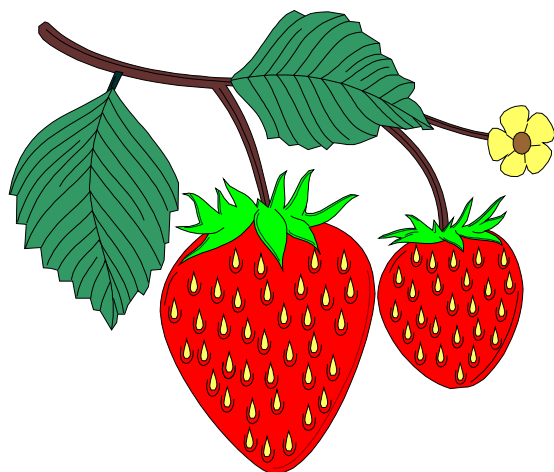

ASSOCIAZIONI DI IMMAGINI UGUALI O SIMILI
Far denominare e associare le immagini uguali o simili.

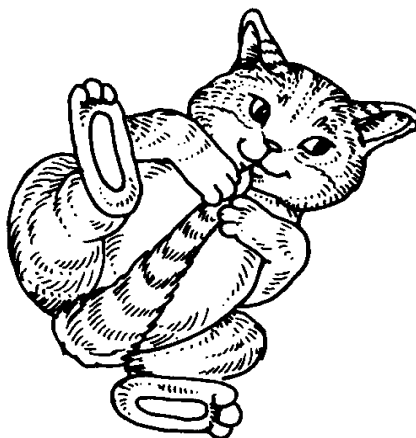
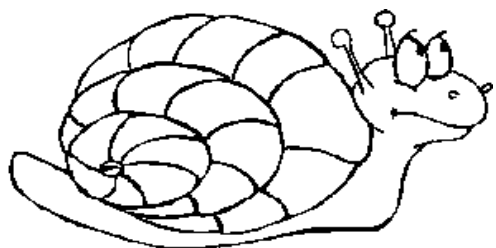
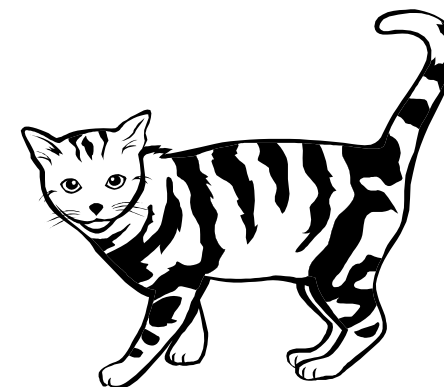
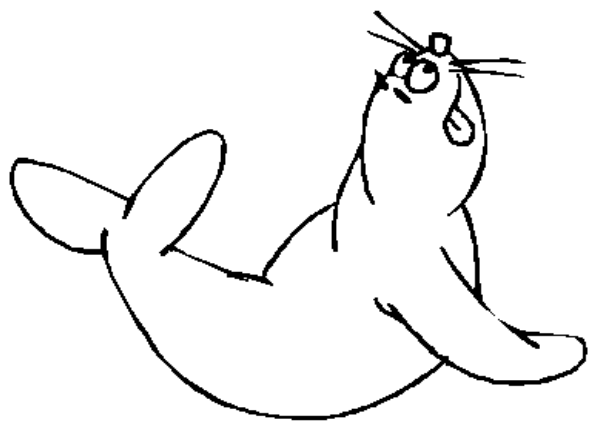

ASSOCIAZIONI DI IMMAGINI UGUALI O SIMILI
Far denominare e associare le immagini uguali o simili.

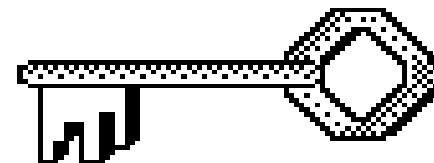
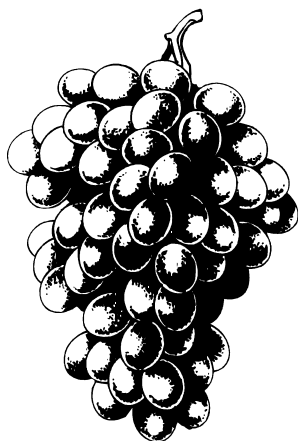
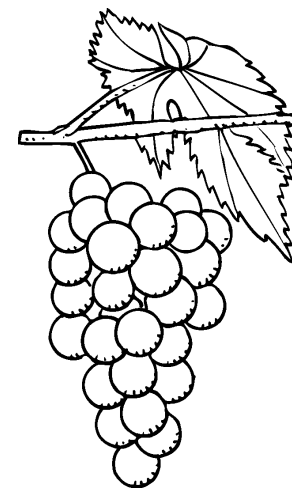
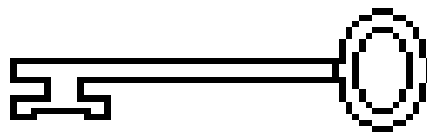
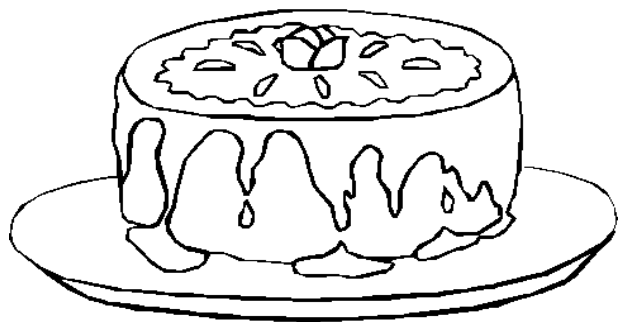

ASSOCIAZIONI DI IMMAGINI UGUALI O SIMILI
Far denominare e associare le immagini uguali o simili.

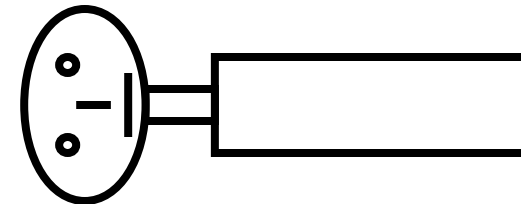
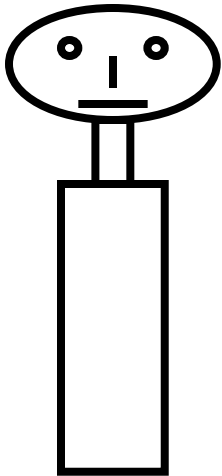
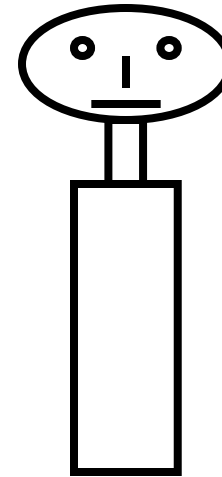
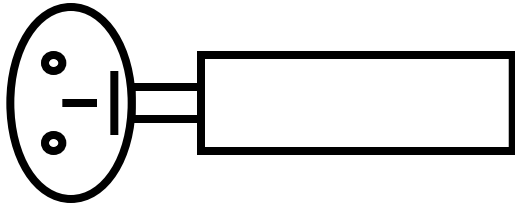

ASSOCIAZIONI DI IMMAGINI UGUALI O SIMILI
Far denominare e associare le immagini uguali o simili.

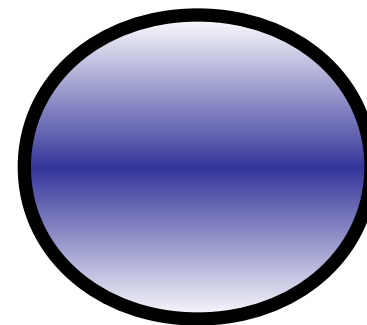
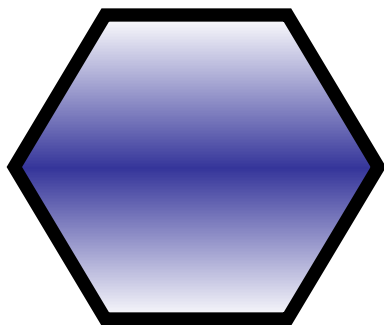
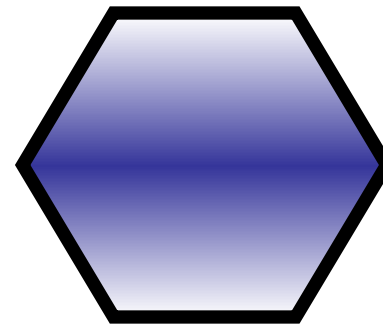
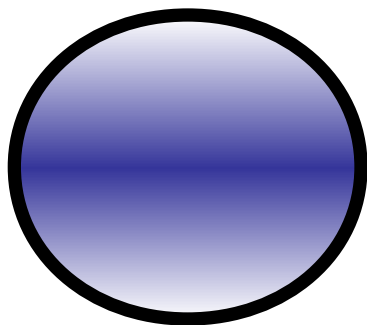

ASSOCIAZIONI DI IMMAGINI UGUALI O SIMILI
Far denominare e associare le immagini uguali o simili.

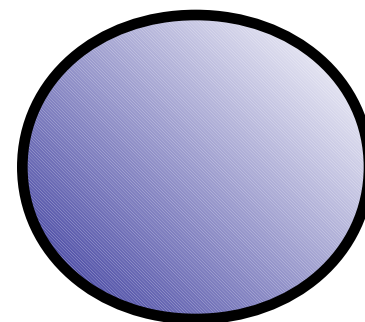
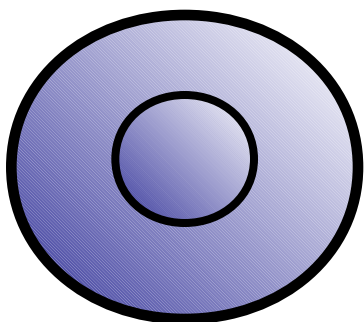
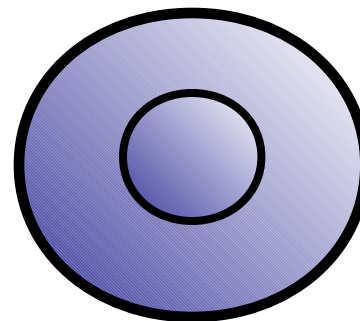
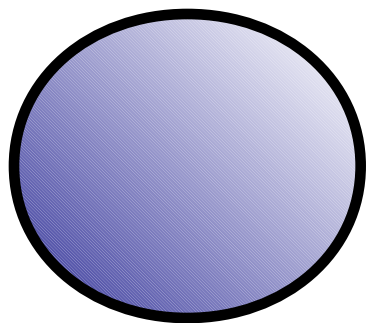

ASSOCIAZIONI DI IMMAGINI UGUALI O SIMILI
Far denominare e associare le immagini uguali o simili.

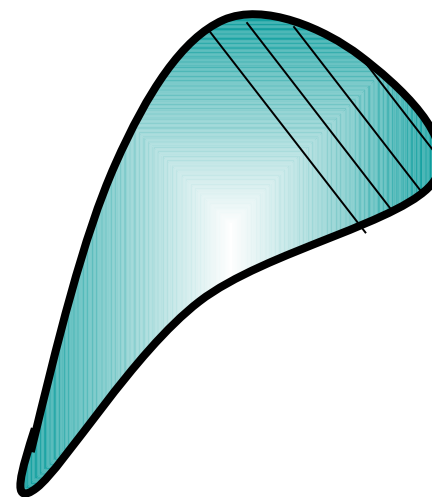
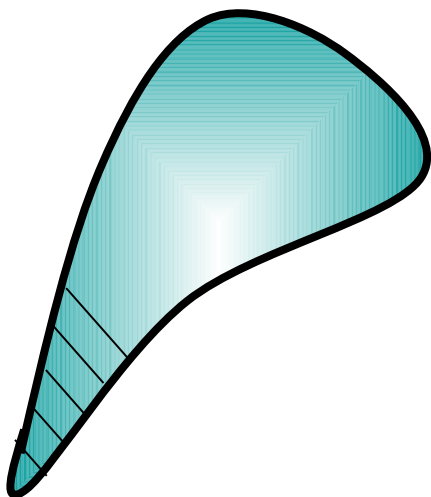
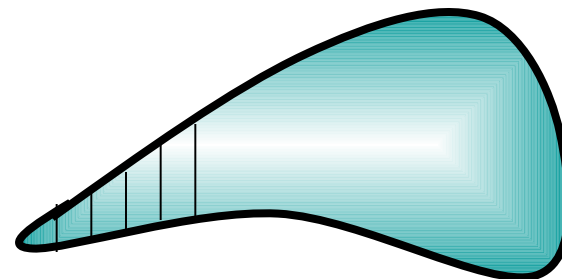
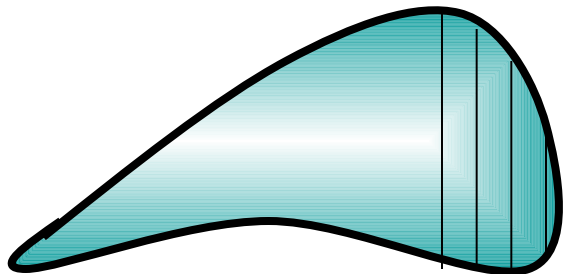

ASSOCIAZIONI DI IMMAGINI UGUALI O SIMILI
Far denominare e associare le immagini uguali o simili.

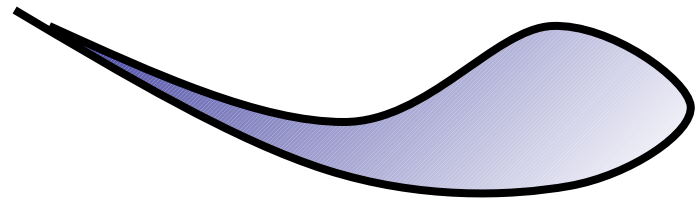
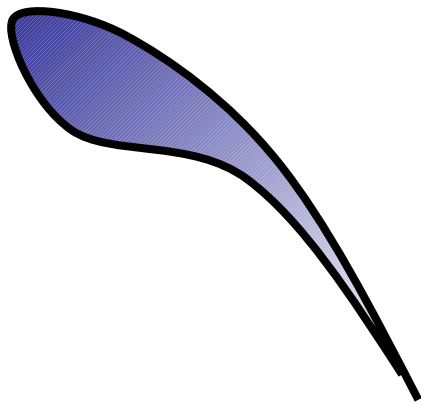
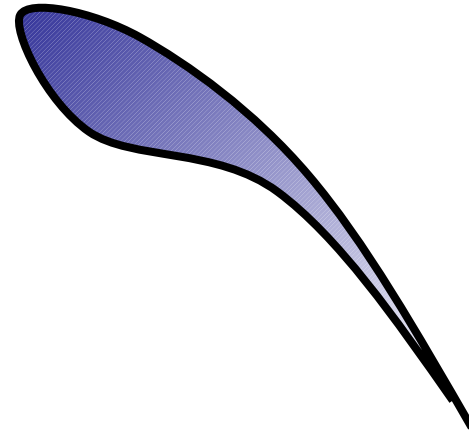
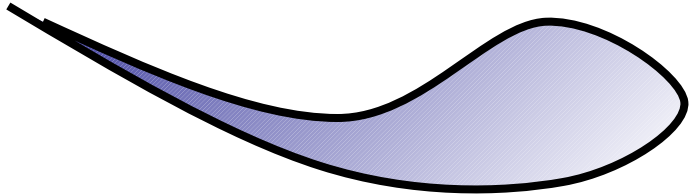

ASSOCIAZIONI DI IMMAGINI UGUALI O SIMILI
Far denominare e associare le immagini uguali o simili.

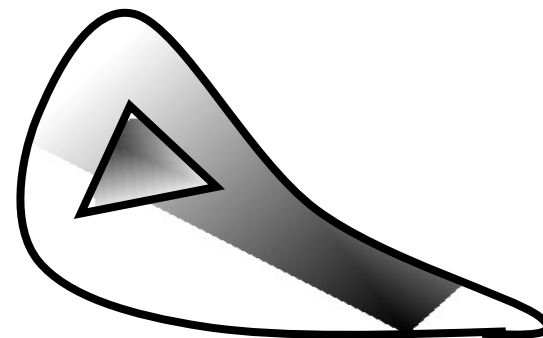
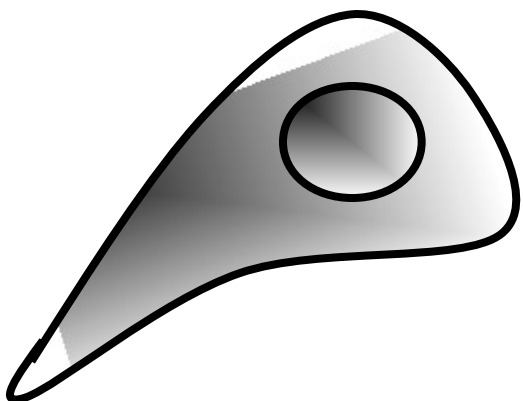
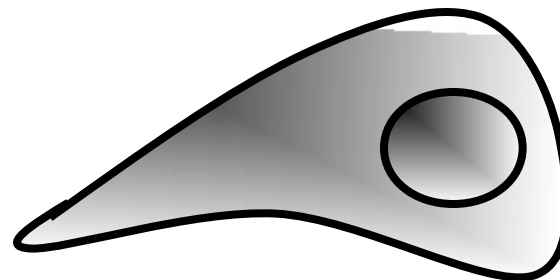
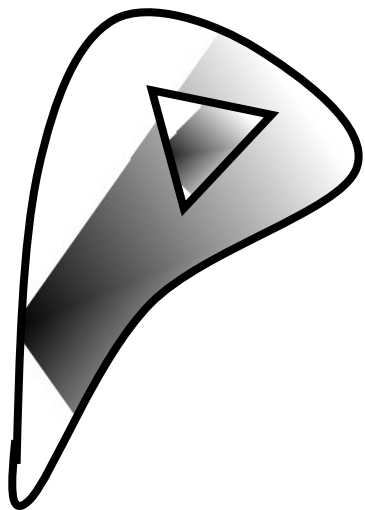

ASSOCIAZIONI DI IMMAGINI UGUALI O SIMILI
Far denominare e associare le immagini uguali o simili.

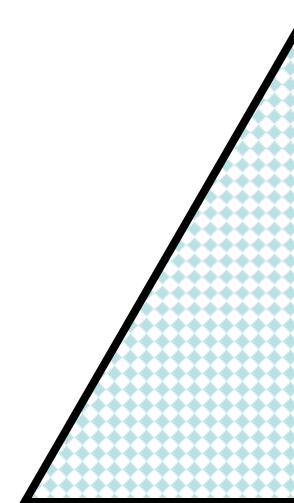
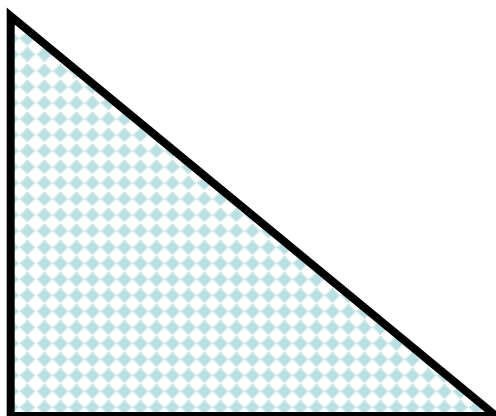
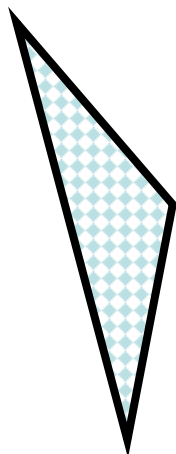
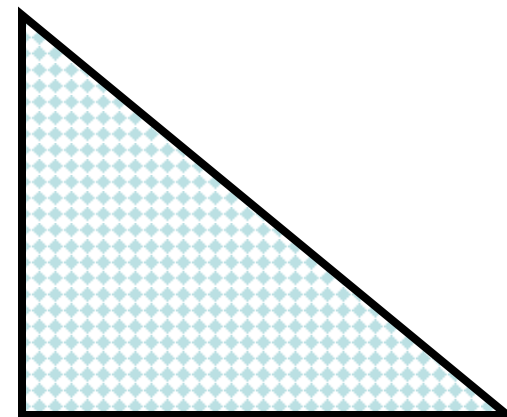
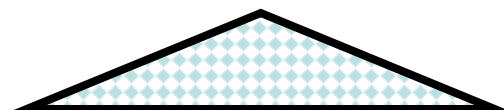
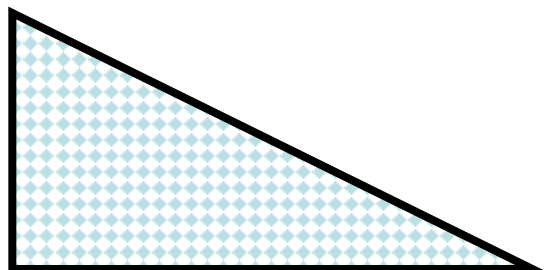

ASSOCIAZIONI DI IMMAGINI UGUALI O SIMILI
Far denominare e associare le immagini uguali o simili.

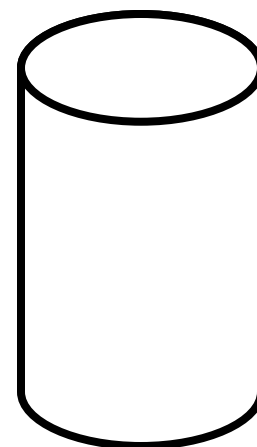
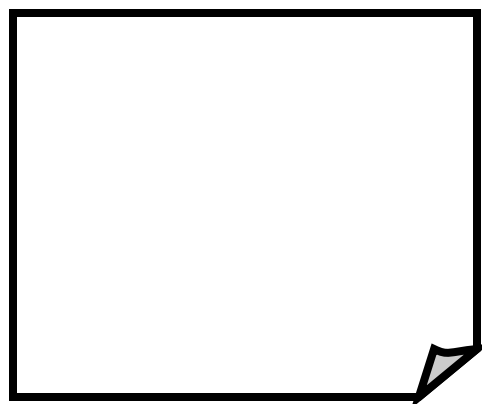
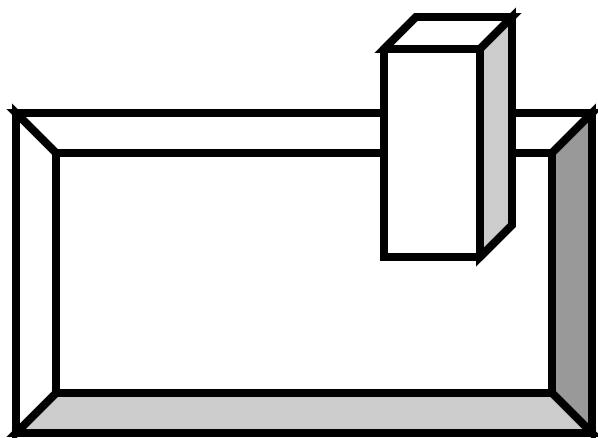
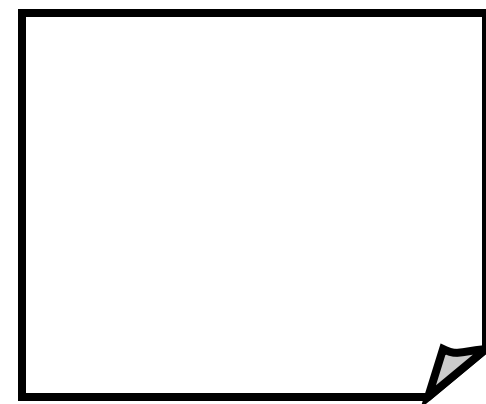
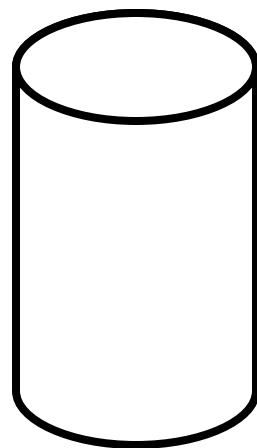
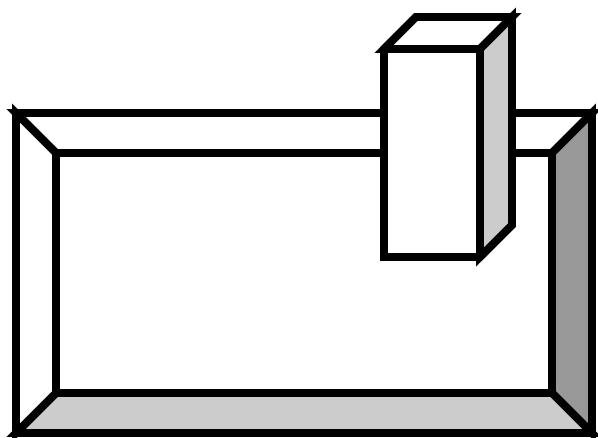

ASSOCIAZIONI DI IMMAGINI UGUALI O SIMILI
Far denominare e associare le immagini uguali o simili.

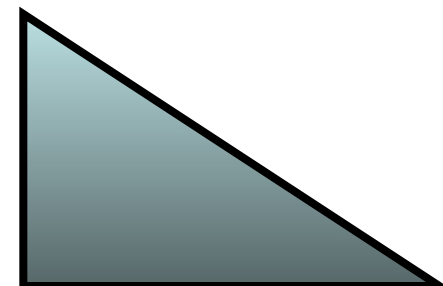
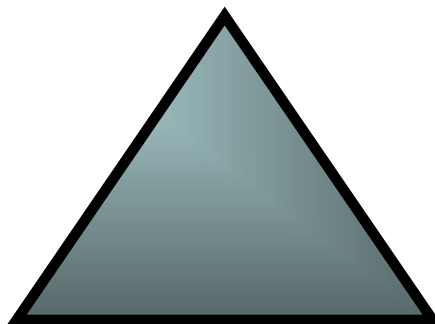
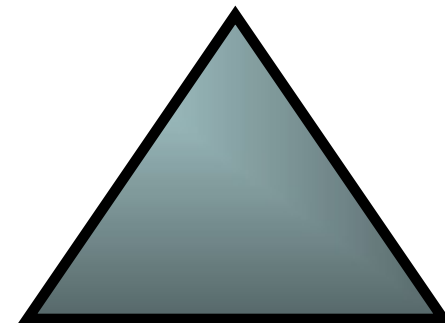
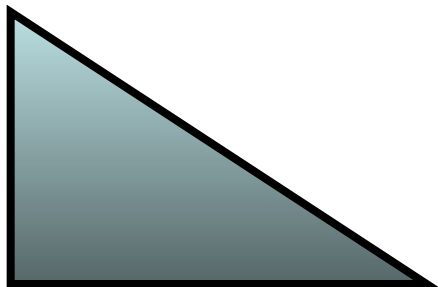

ASSOCIAZIONI DI IMMAGINI UGUALI O SIMILI
Far denominare e associare le immagini uguali o simili.

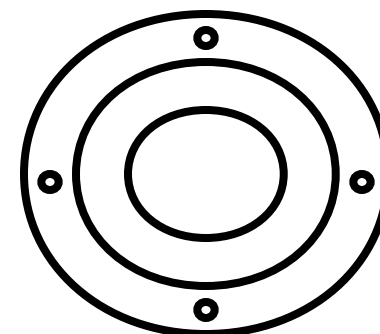
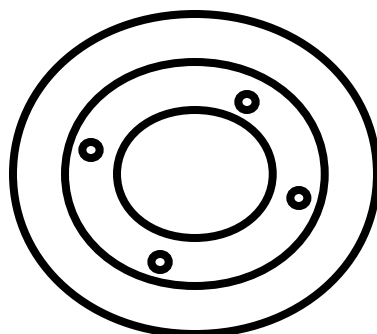
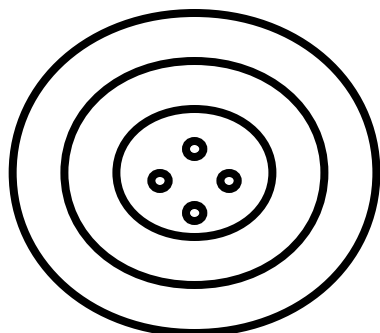
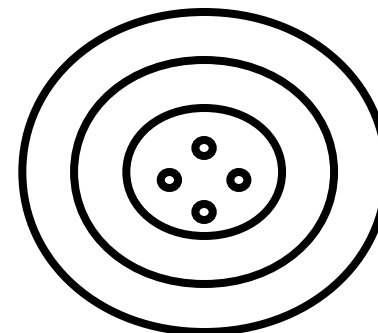
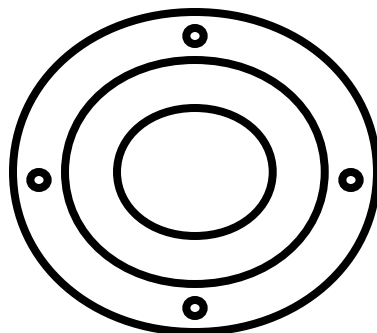
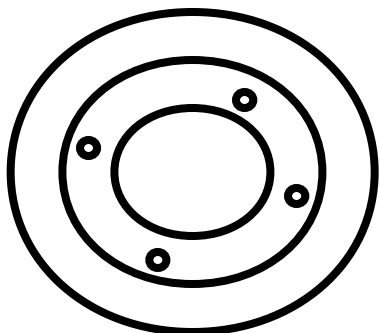

ASSOCIAZIONI DI IMMAGINI UGUALI O SIMILI
Far denominare e associare le immagini uguali o simili.

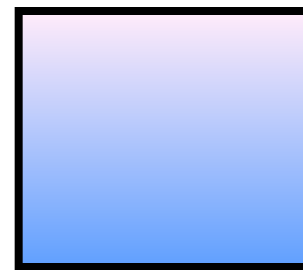
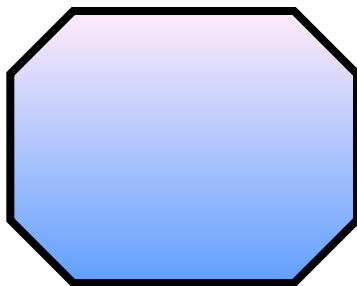
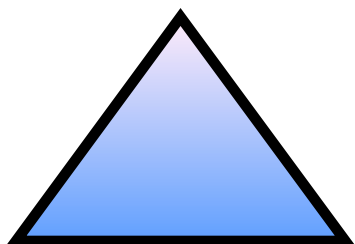
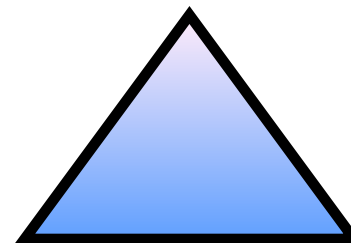
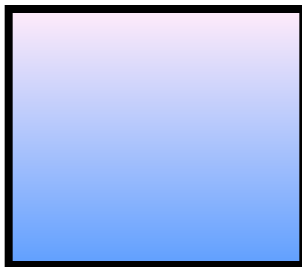
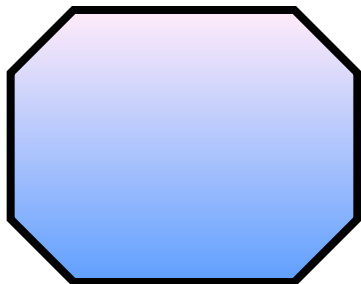

ASSOCIAZIONI DI IMMAGINI UGUALI O SIMILI
Far denominare e associare le immagini uguali o simili.

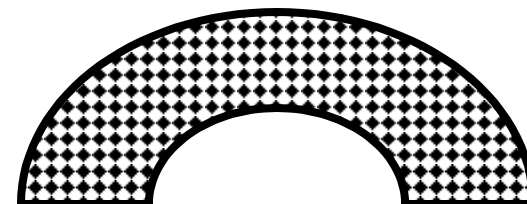
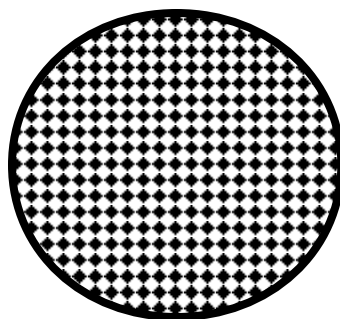
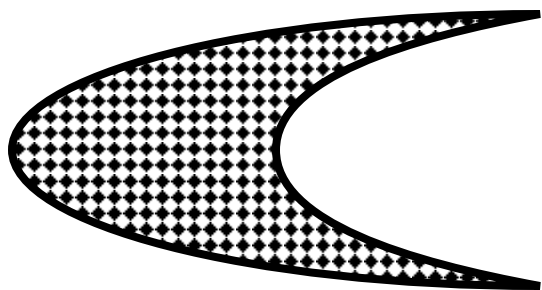
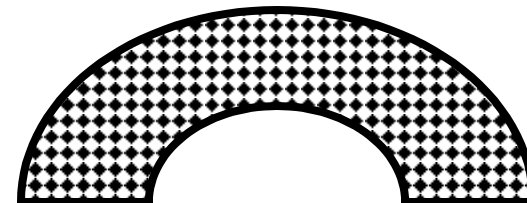
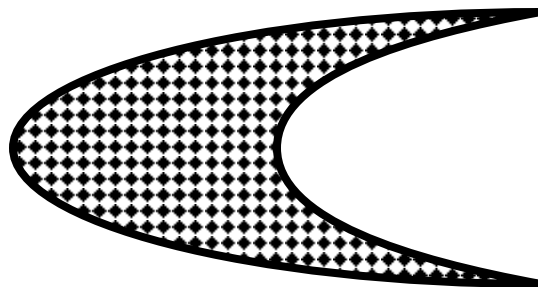
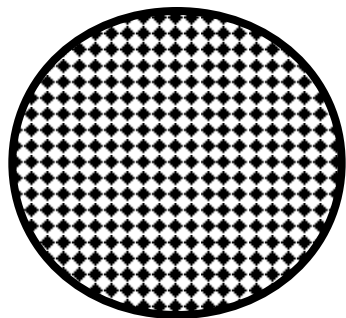

ASSOCIAZIONI DI IMMAGINI UGUALI O SIMILI
Far denominare e associare le immagini uguali o simili.

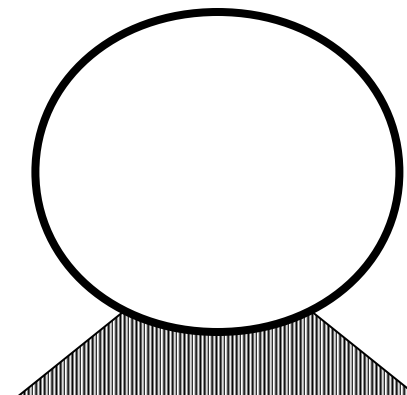
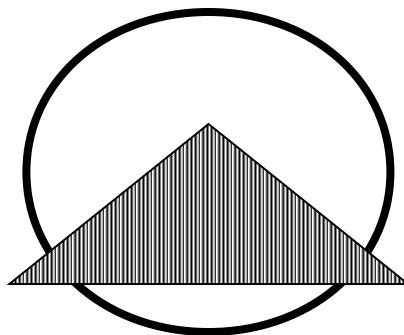
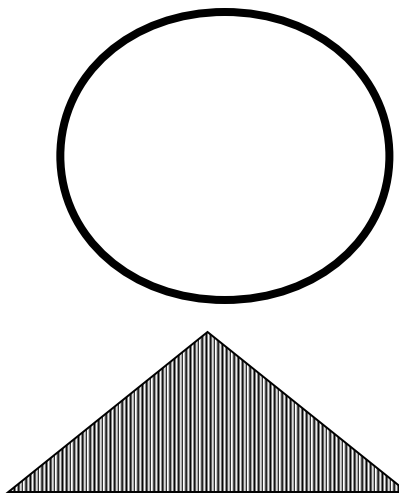
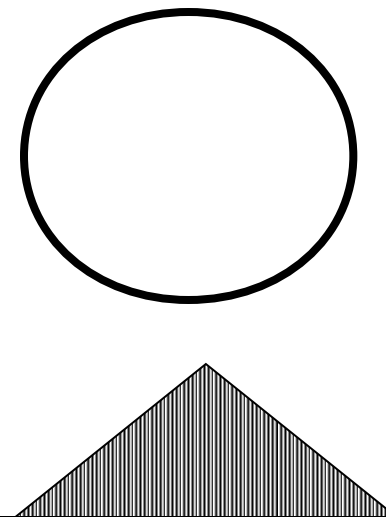
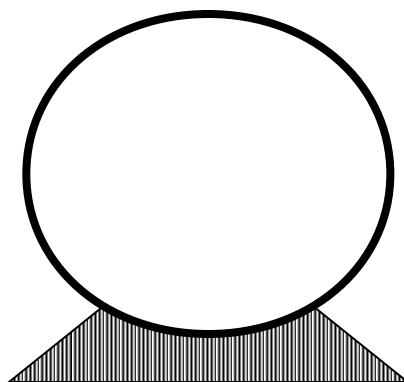
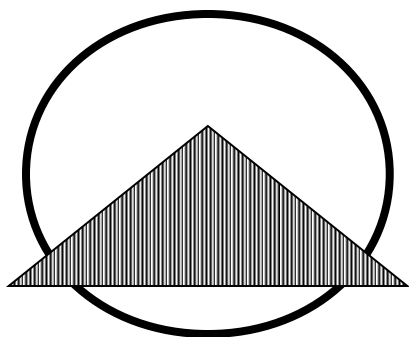

ASSOCIAZIONI DI IMMAGINI UGUALI O SIMILI
Far denominare e associare le immagini uguali o simili.

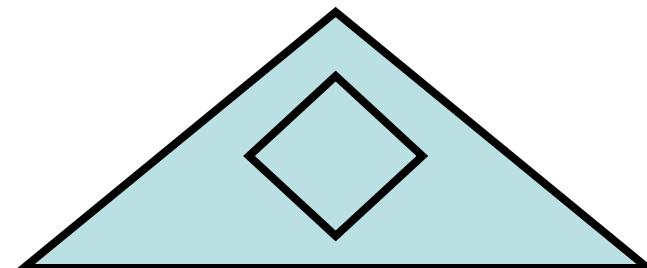
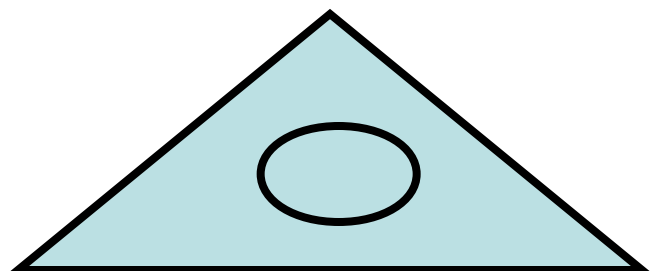
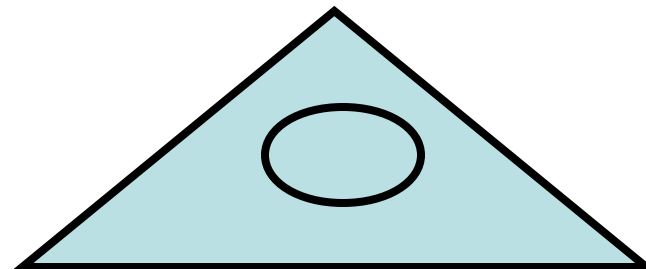
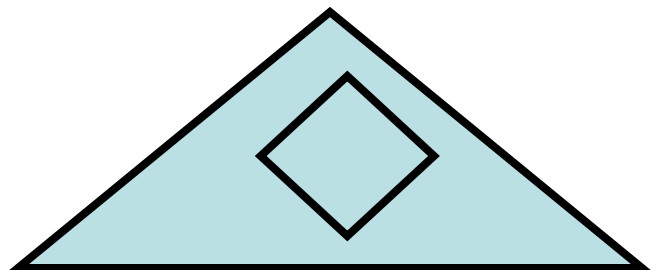

ASSOCIAZIONI DI IMMAGINI UGUALI O SIMILI
Far denominare e associare le immagini uguali o simili.

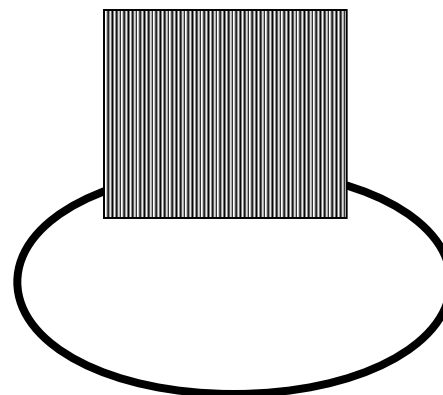
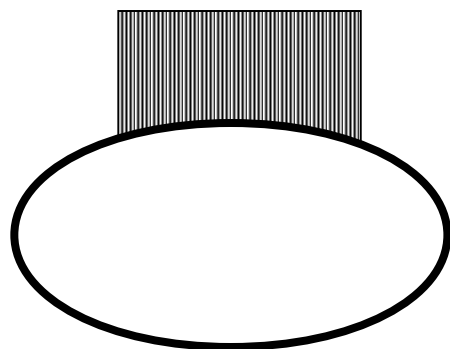
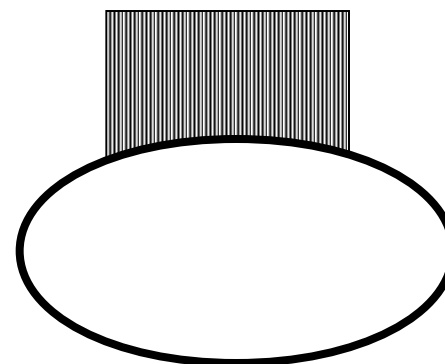
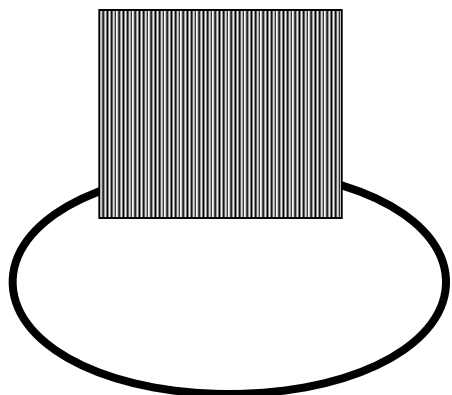

ASSOCIAZIONI DI IMMAGINI UGUALI O SIMILI
Far denominare e associare le immagini uguali o simili.

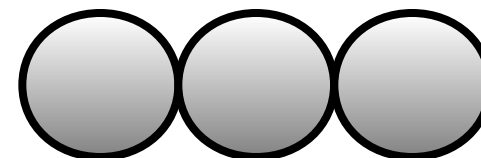
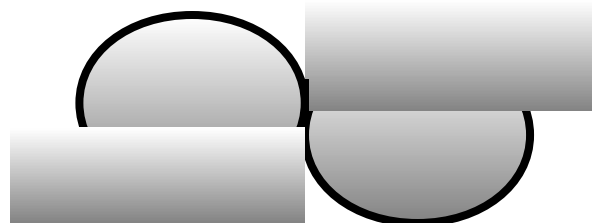
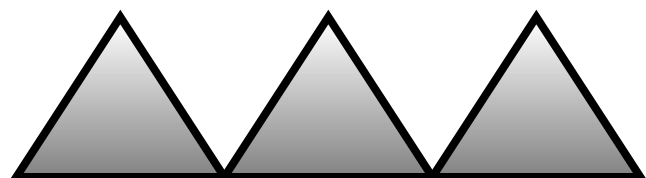
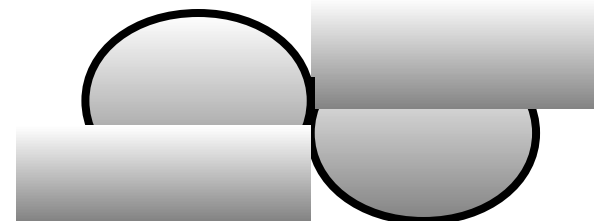
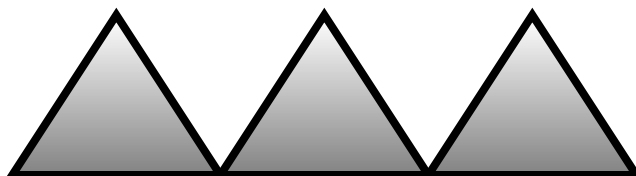
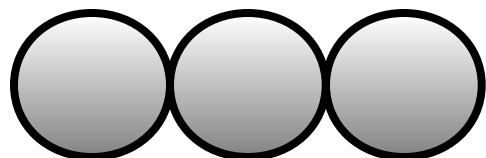

ASSOCIAZIONI DI IMMAGINI UGUALI O SIMILI
Far denominare e associare le immagini uguali o simili.

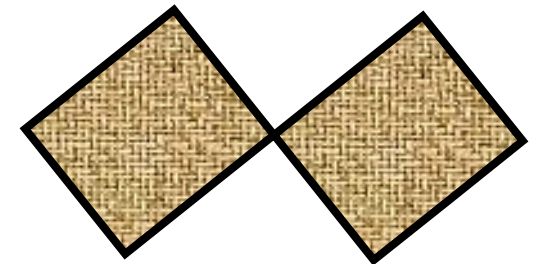
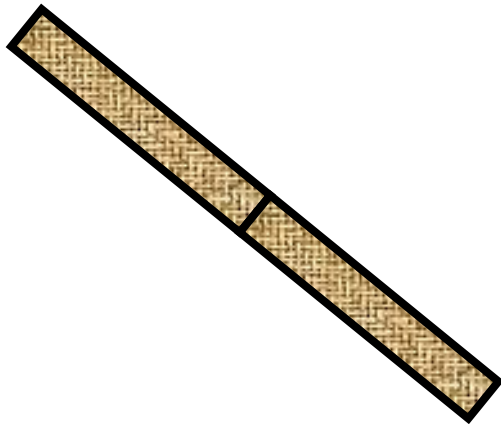
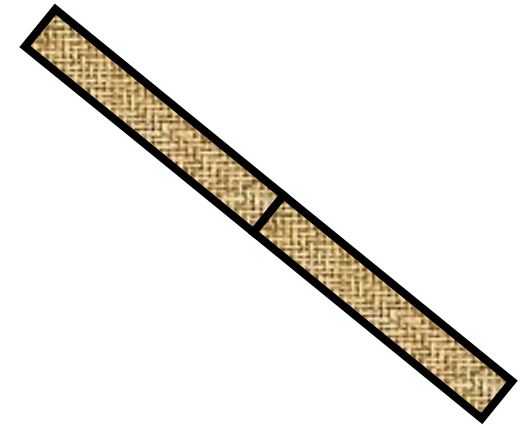
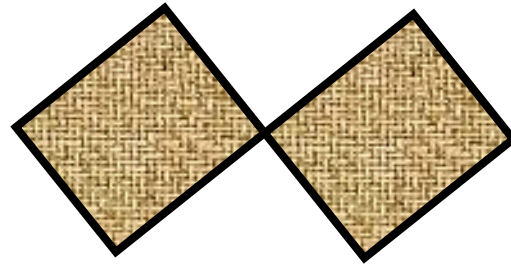

ASSOCIAZIONI DI IMMAGINI UGUALI O SIMILI
Far denominare e associare le immagini uguali o simili.

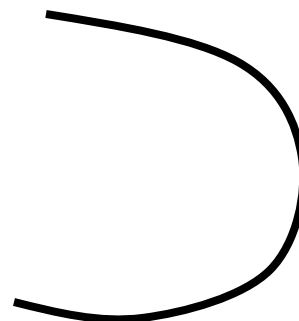
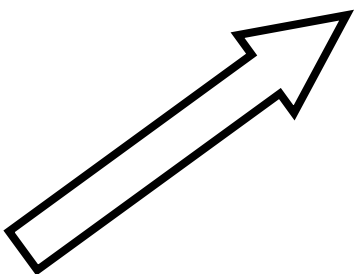
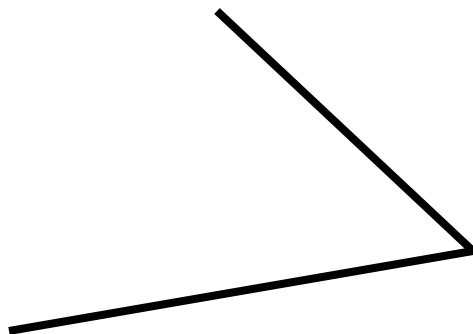
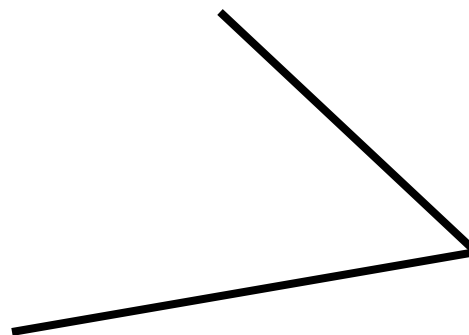
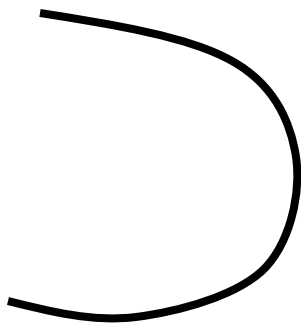
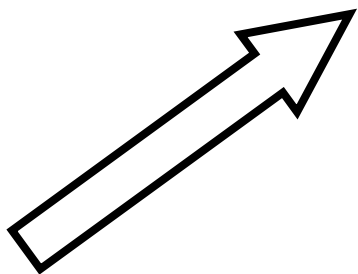

ASSOCIAZIONI DI IMMAGINI UGUALI O SIMILI
Far denominare e associare le immagini uguali o simili.

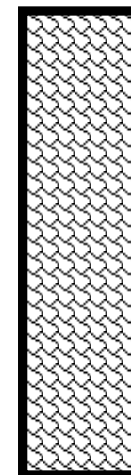
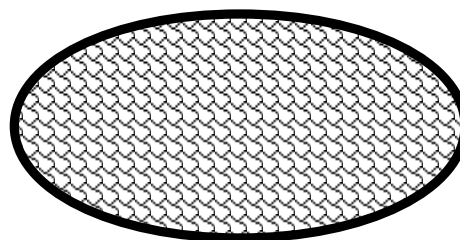
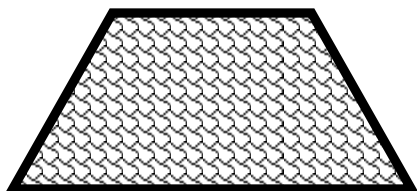
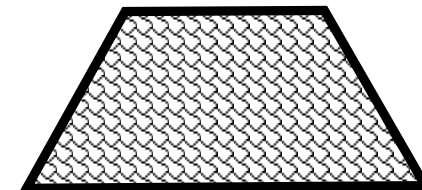
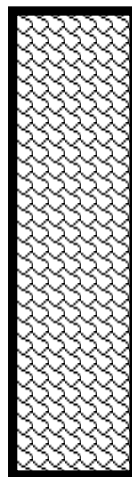
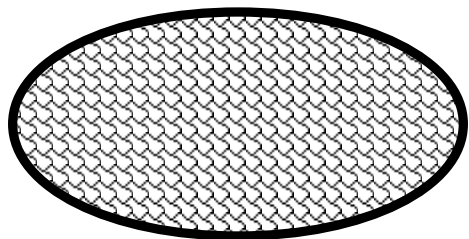

ASSOCIAZIONI DI IMMAGINI UGUALI O SIMILI
Far denominare e associare le immagini uguali o simili.

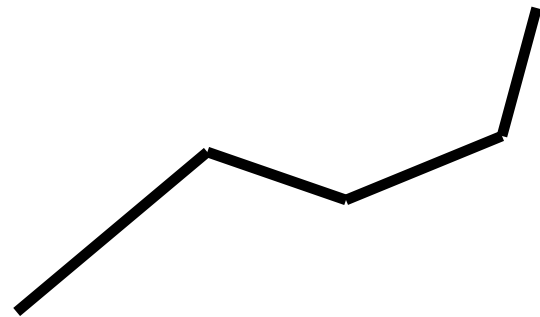
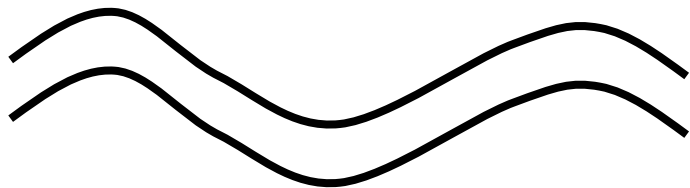
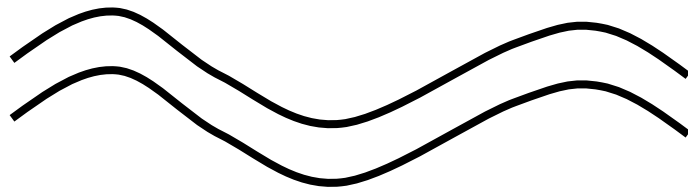
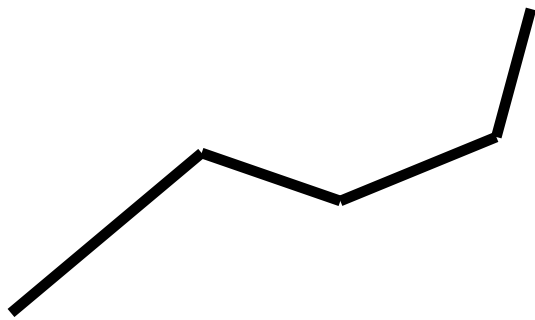

ASSOCIAZIONI DI IMMAGINI UGUALI O SIMILI
Far denominare e associare le immagini uguali o simili.

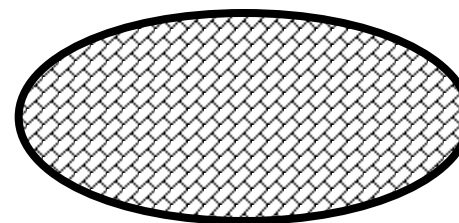
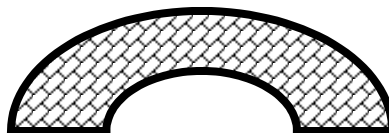
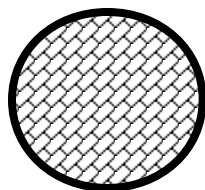
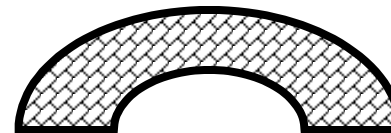
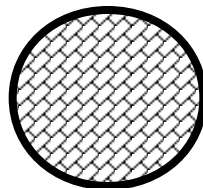
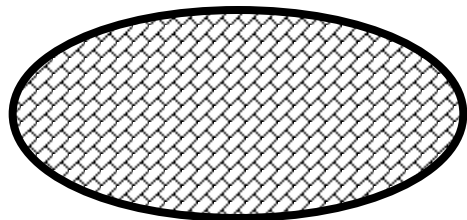

ASSOCIAZIONI DI IMMAGINI UGUALI O SIMILI
Far denominare e associare le immagini uguali o simili.

ASSOCIAZIONI LOGICHE

L'attività di associare un oggetto, un animale, un vegetale o una forma geometrica ad un altro, ricercando un possibile legame logico di uso, funzione, forma, posizione nello spazio, somiglianza, causa - effetto, parte - tutto ecc. implica la stimolazione di processi di astrazione, classificazione ed organizzazione spaziale, basilari per lo sviluppo intellettuale.

UTILIZZAZIONE

Per utilizzare tali schede basta indicare al bambino l'immagine presente nella parte sinistra, chiedendo di associarla con un'altra disegnata nella parte destra. Nei bambini sordi, si cercherà di utilizzare il segno mimico che significa legame. Dopo che il bambino avrà effettuato l'associazione l'educatore chiarirà il motivo che lo ha spinto ad effettuare tale scelta.

ETA' DI RIFERIMENTO

Quattro anni nello sviluppo logico.

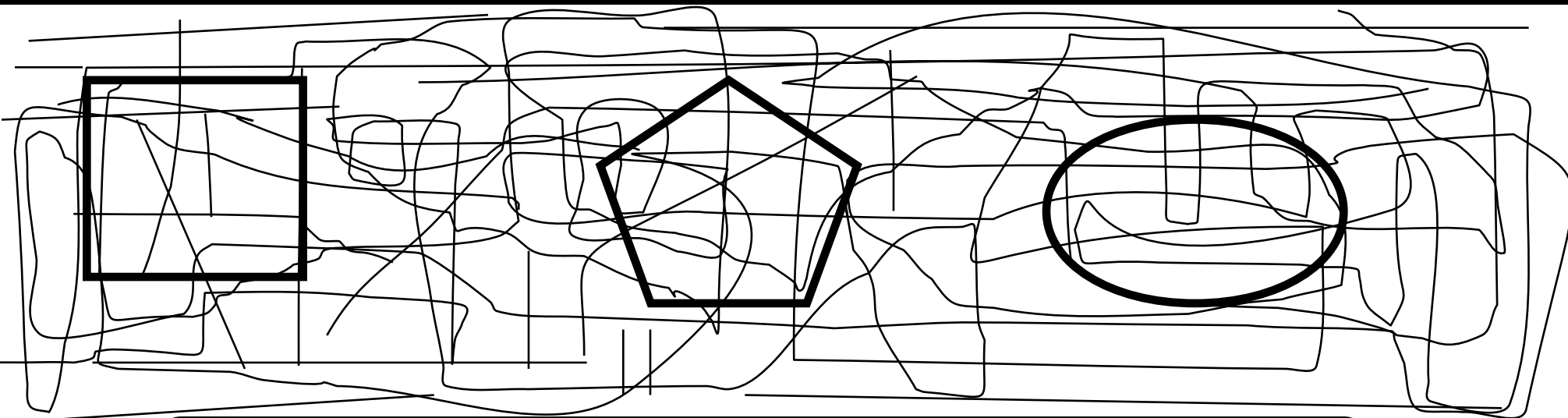
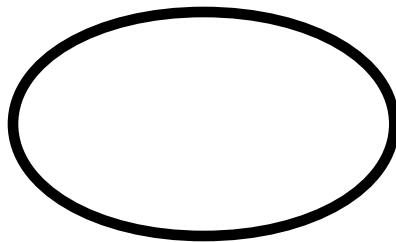
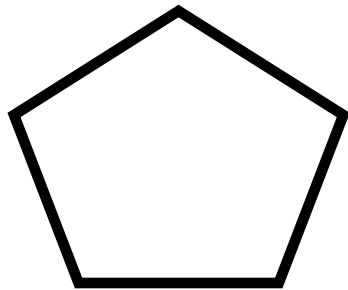

ASSOCIAZIONI LOGICHE

Associare le immagini secondo un legame logico.

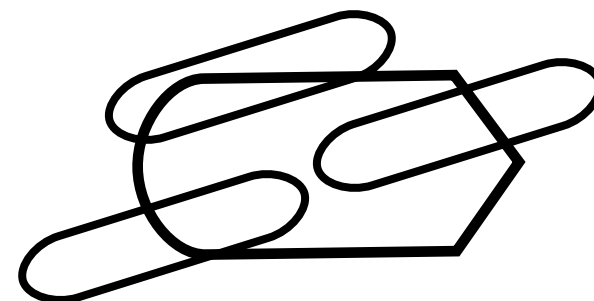
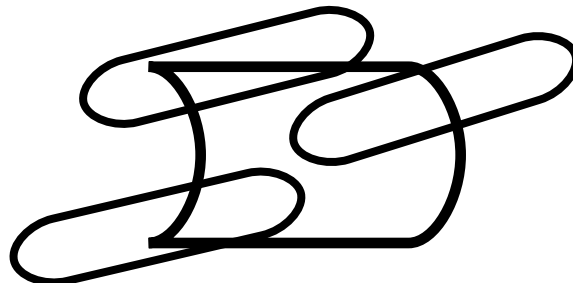
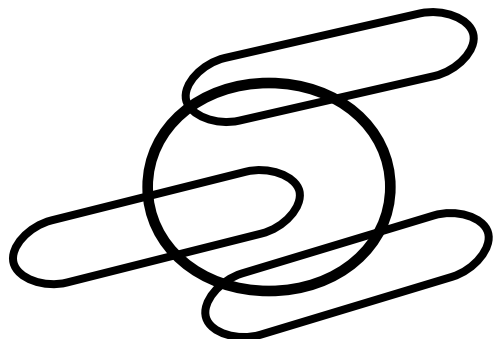
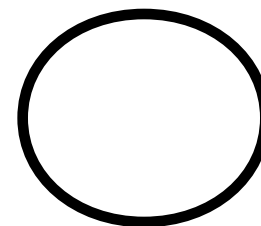
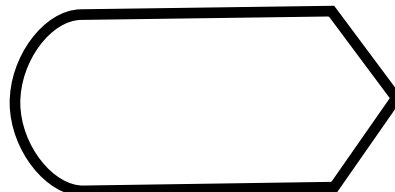

ASSOCIAZIONI LOGICHE

Associare le immagini secondo un legame logico.

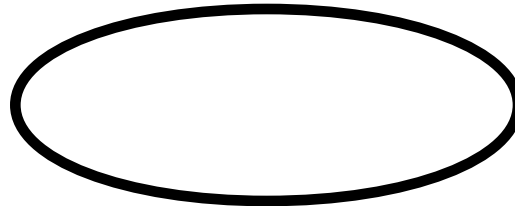
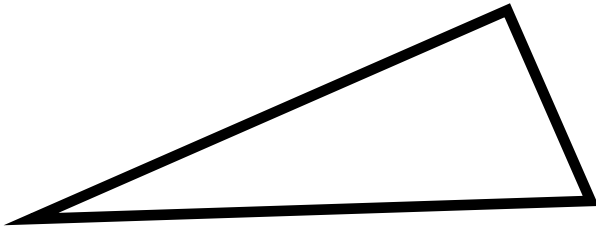
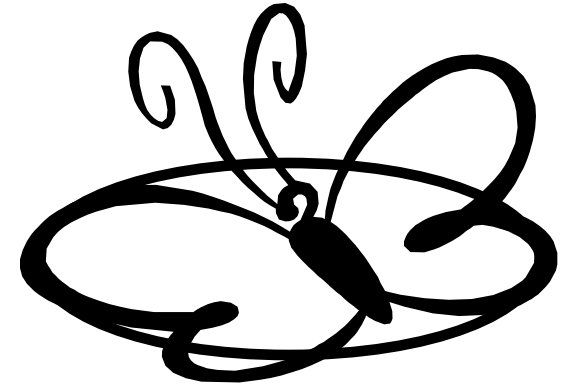

ASSOCIAZIONI LOGICHE

Associare le immagini secondo un legame logico.

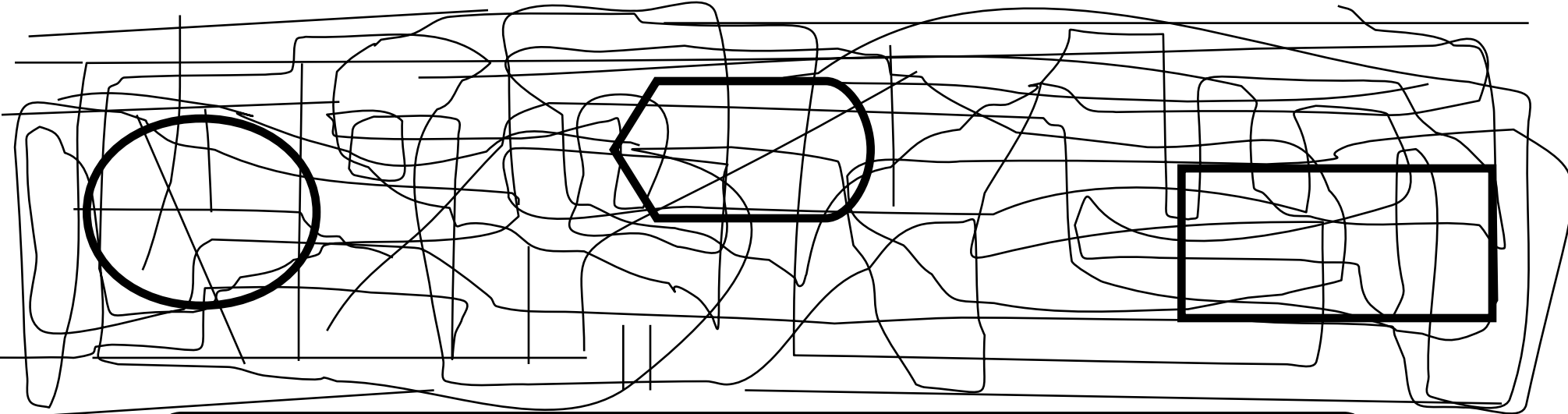
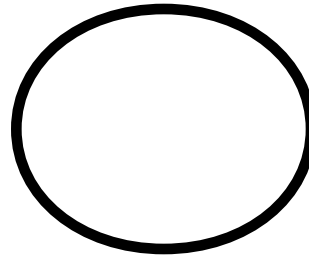

ASSOCIAZIONI LOGICHE

Associare le immagini secondo un legame logico.

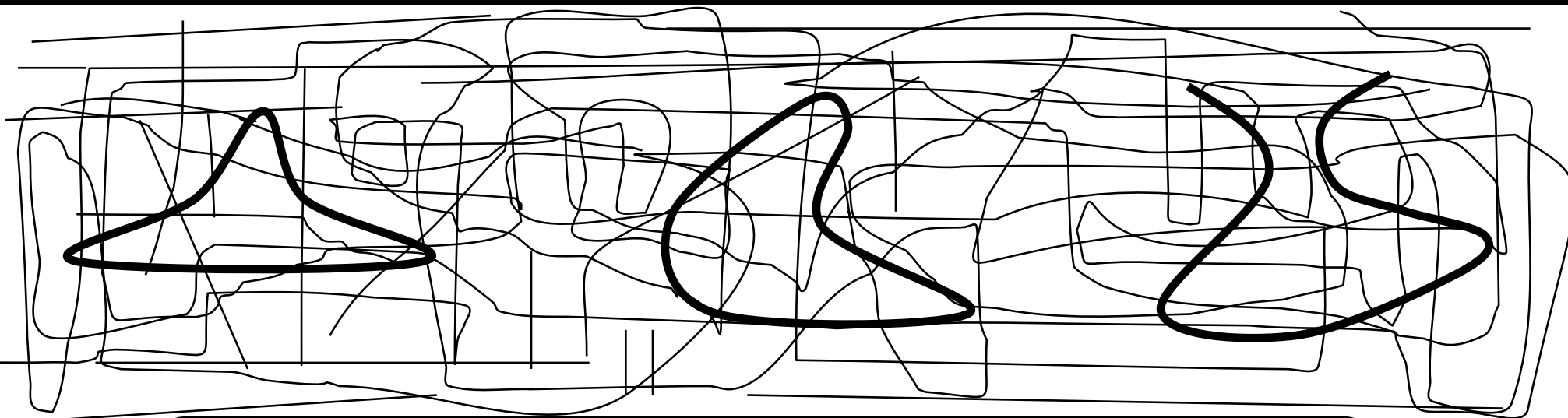
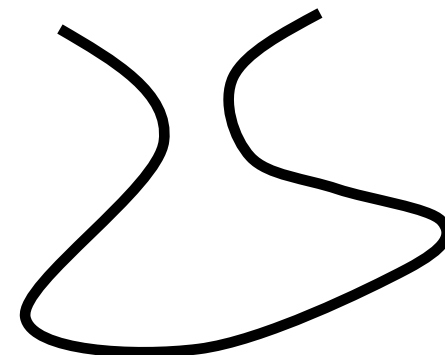
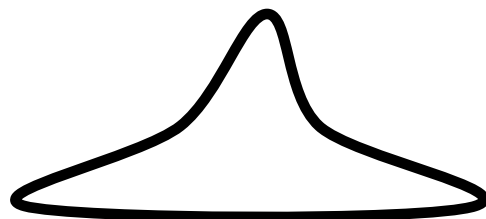
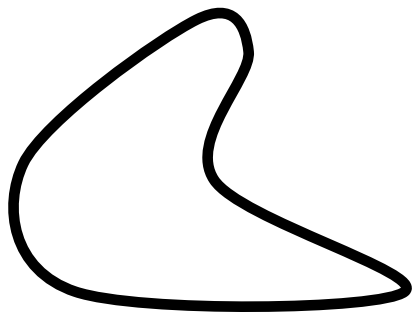

ASSOCIAZIONI LOGICHE

Associare le immagini secondo un legame logico.

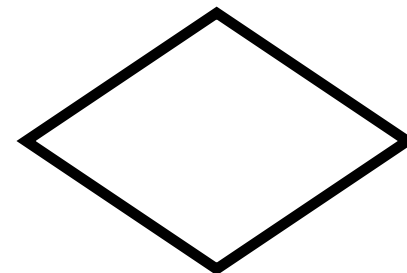
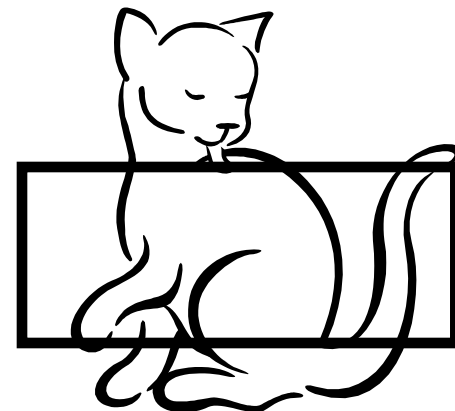
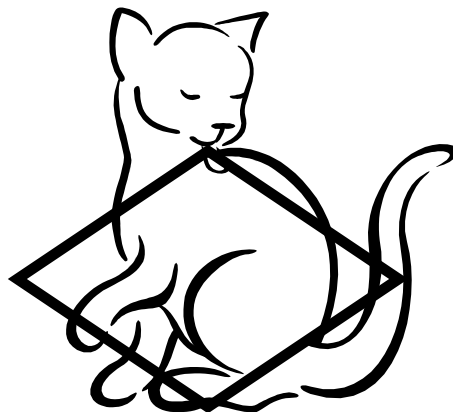
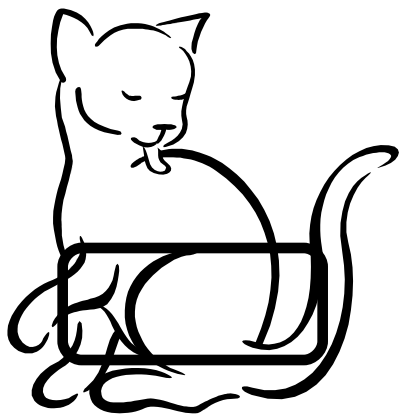

ASSOCIAZIONI LOGICHE

Associare le immagini secondo un legame logico.

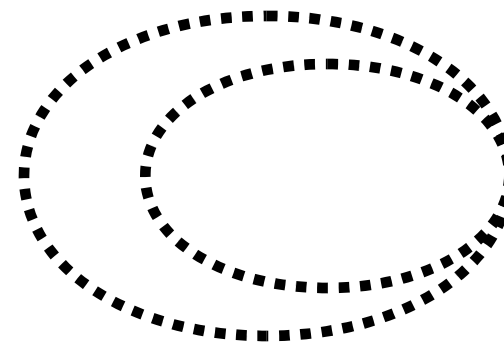
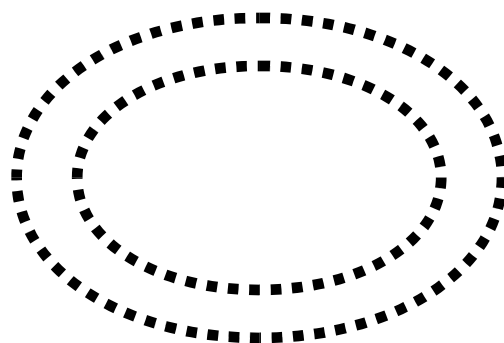
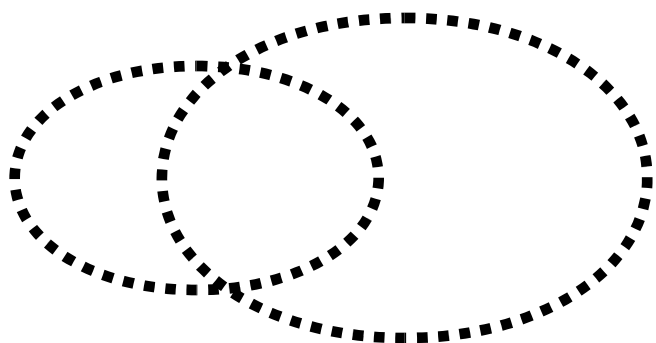
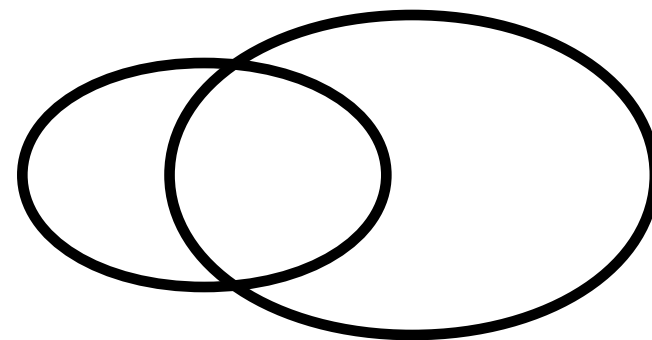
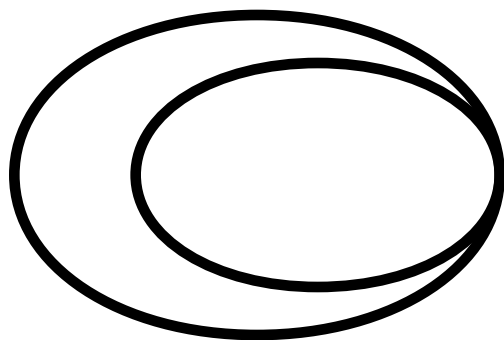
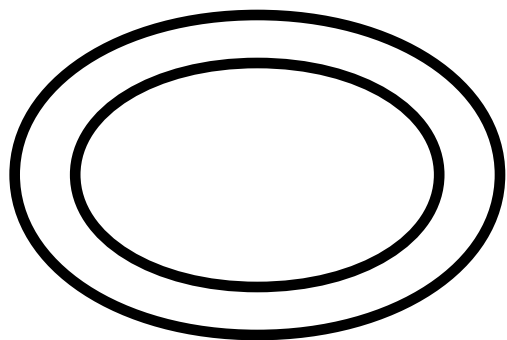

ASSOCIAZIONI LOGICHE

Associare le immagini secondo un legame logico.

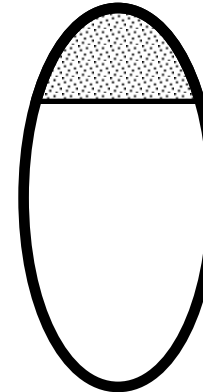
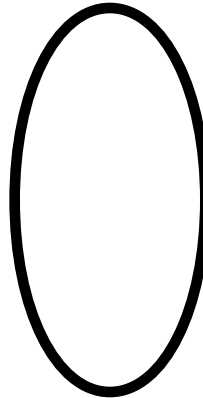
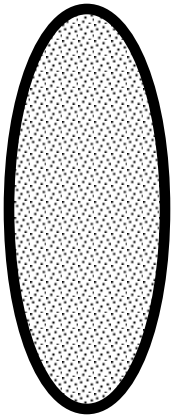
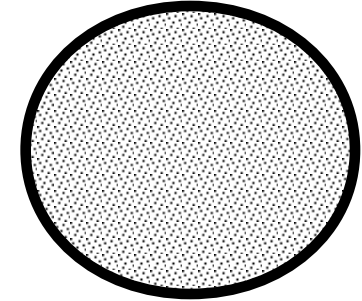
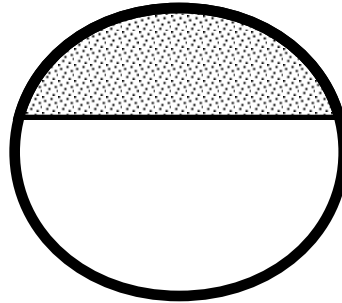
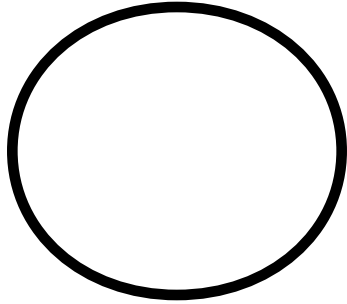

ASSOCIAZIONI LOGICHE
Associare le immagini secondo un legame logico.

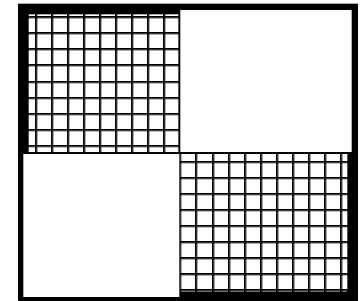
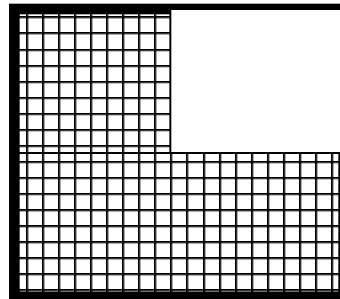
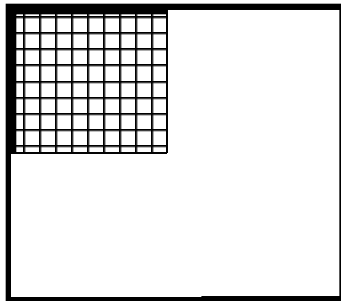
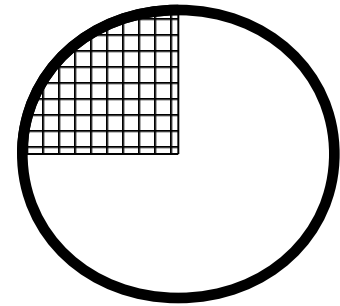
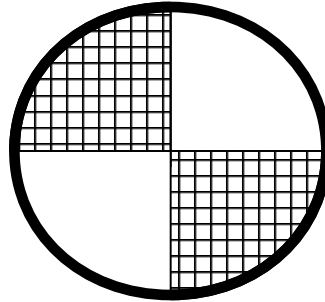
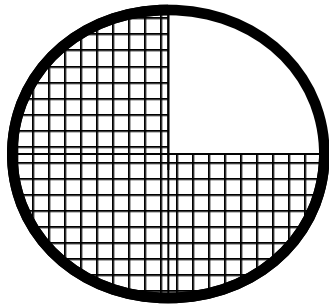

ASSOCIAZIONI LOGICHE
Associare le immagini secondo un legame logico.

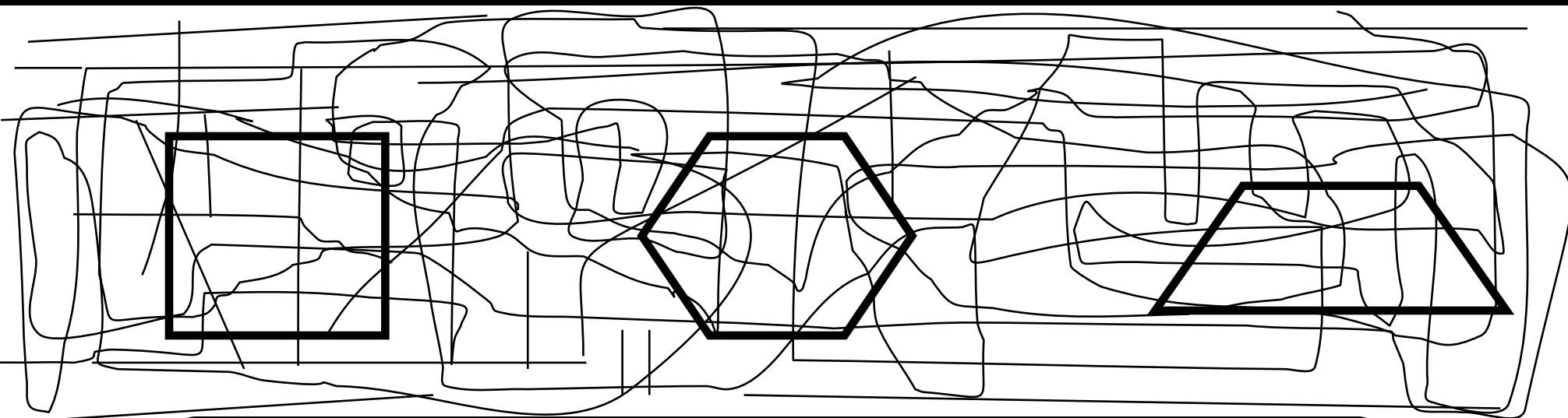
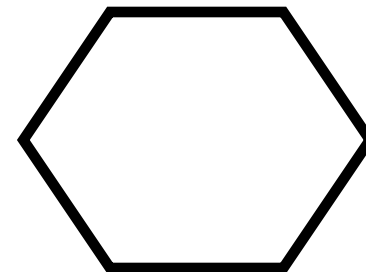

ASSOCIAZIONI LOGICHE

Associare le immagini secondo un legame logico.

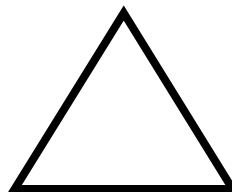
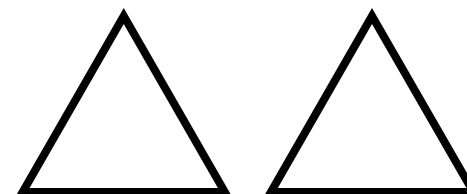
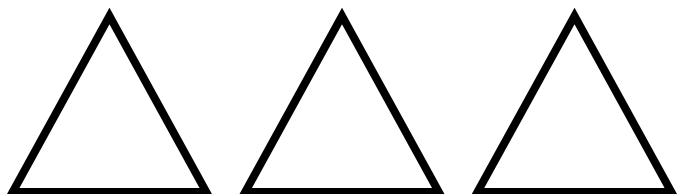
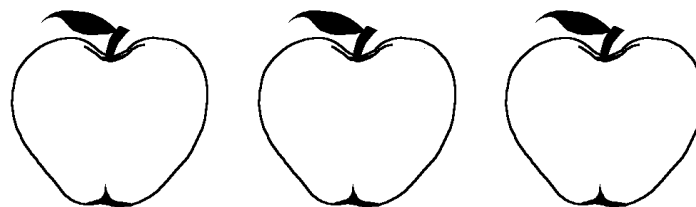
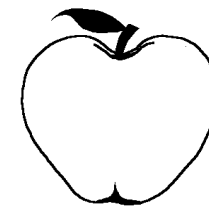
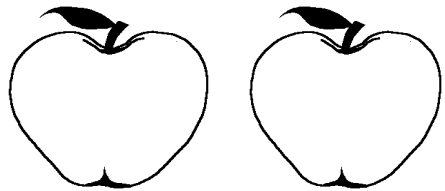

ASSOCIAZIONI LOGICHE

Associare le immagini secondo un legame logico.

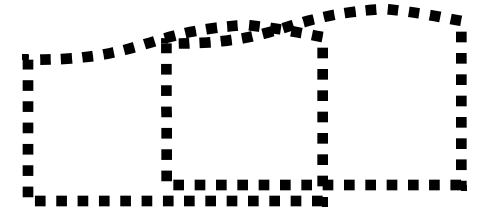
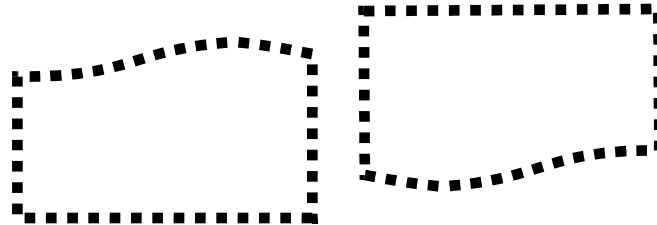
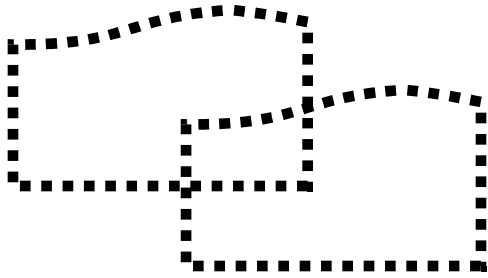
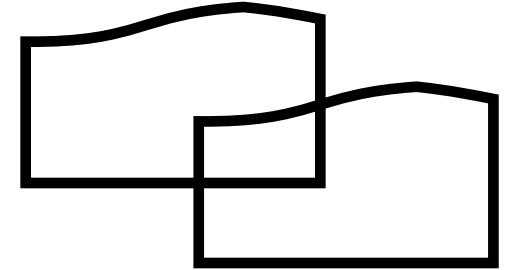
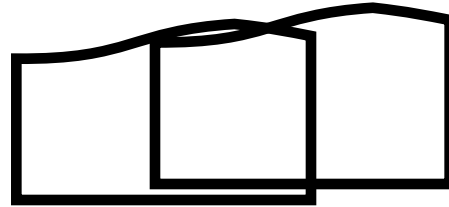
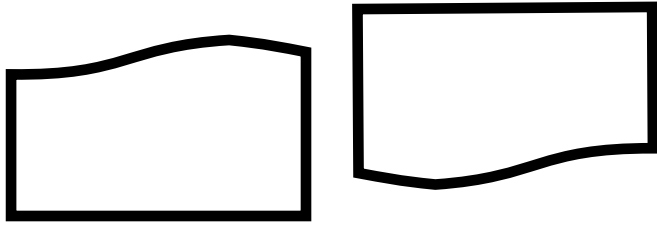

ASSOCIAZIONI LOGICHE

Associare le immagini secondo un legame logico.

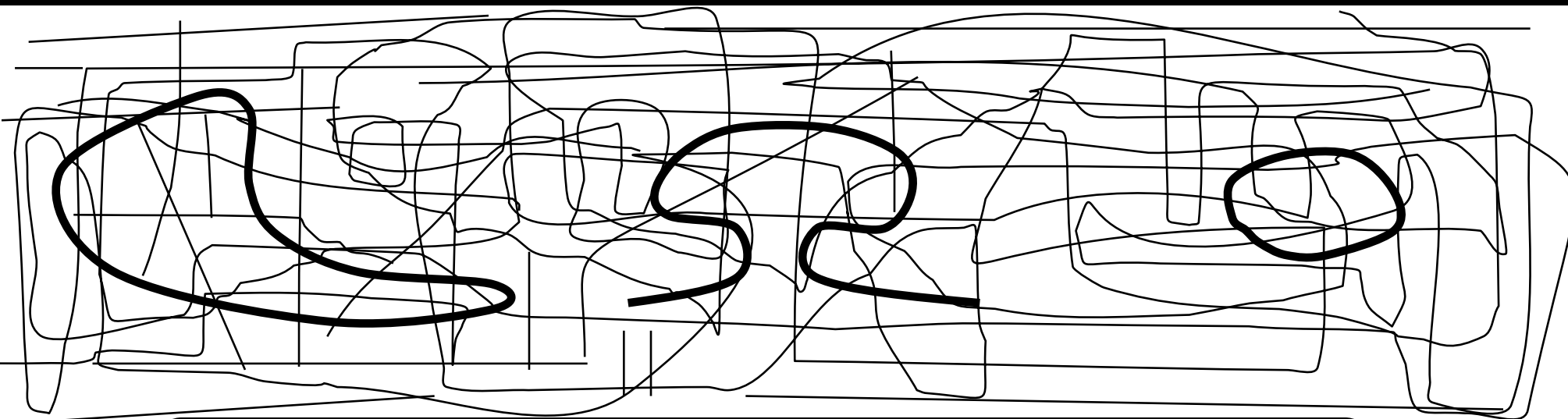
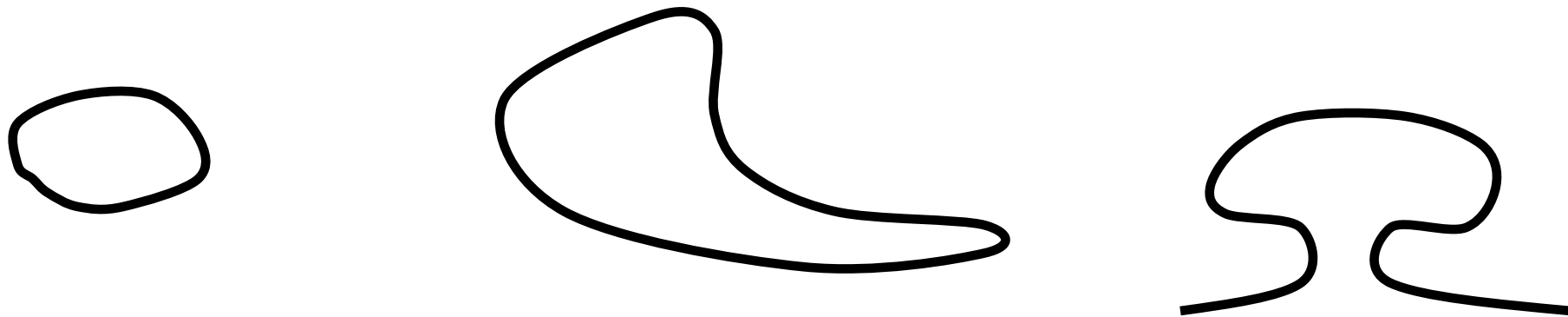

ASSOCIAZIONI LOGICHE

Associare le immagini secondo un legame logico.

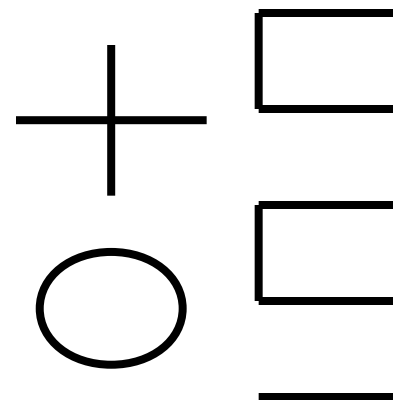
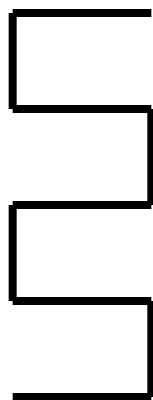
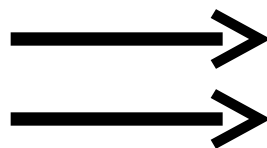
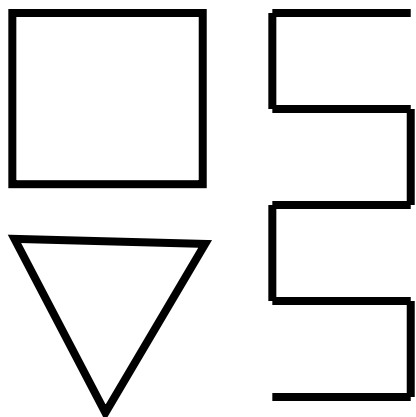
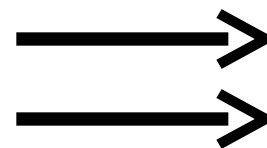
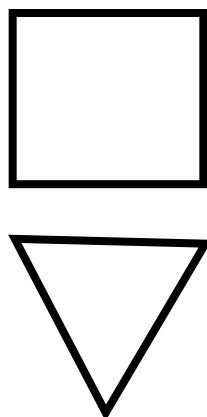
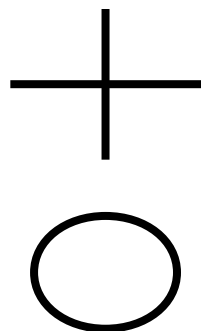

ASSOCIAZIONI LOGICHE

Associare le immagini secondo un legame logico.

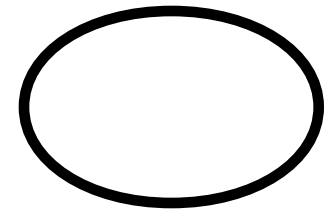
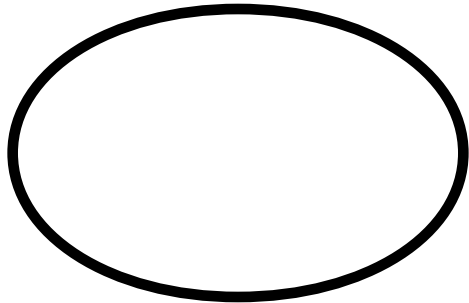
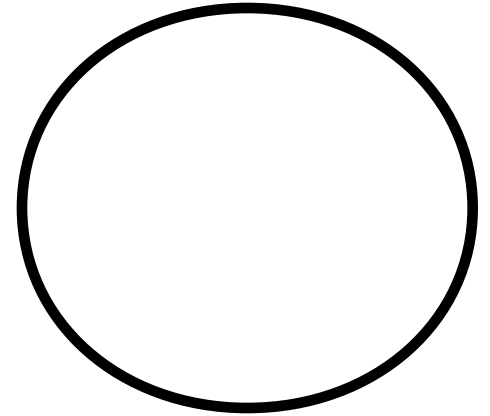
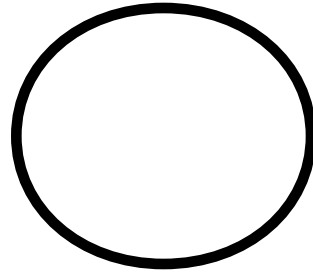
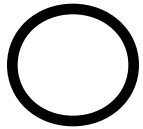

ASSOCIAZIONI LOGICHE

Associare le immagini secondo un legame logico.

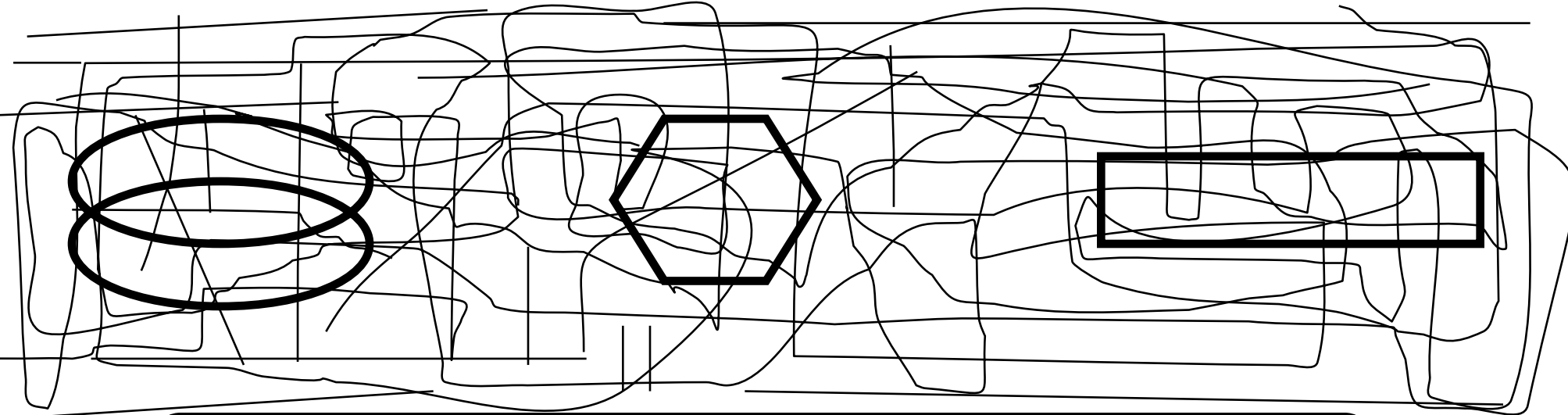
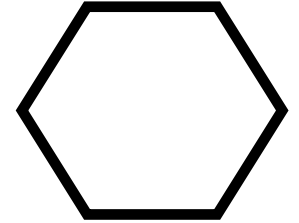
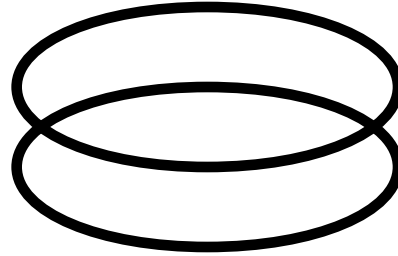

ASSOCIAZIONI LOGICHE

Associare le immagini secondo un legame logico.

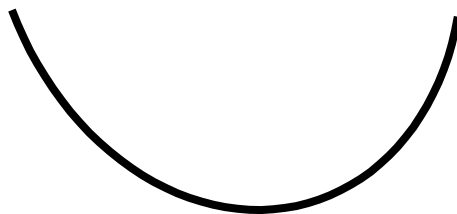
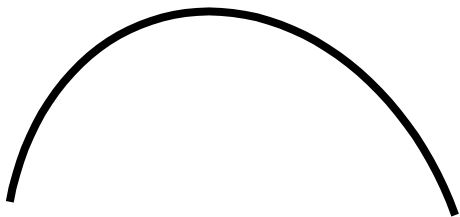
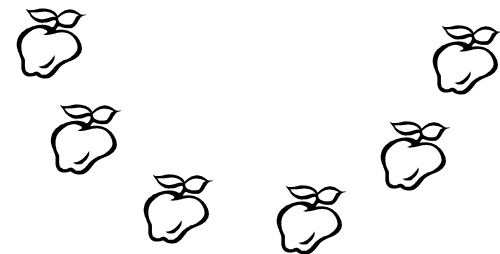
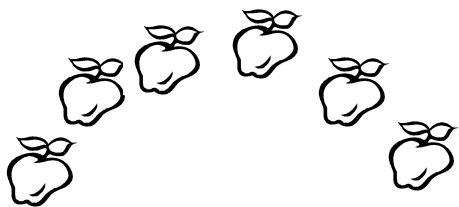

ASSOCIAZIONI LOGICHE

Associare le immagini secondo un legame logico.

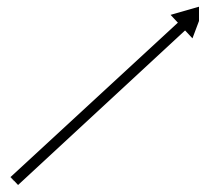
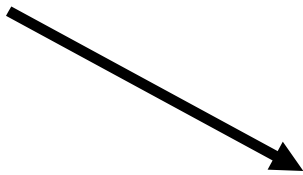
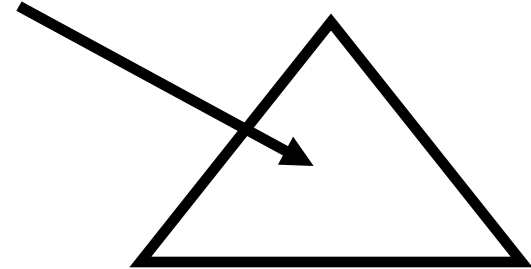
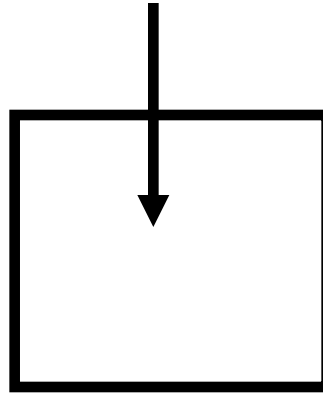
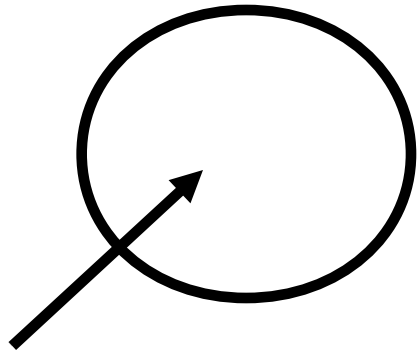

ASSOCIAZIONI LOGICHE

Associare le immagini secondo un legame logico.

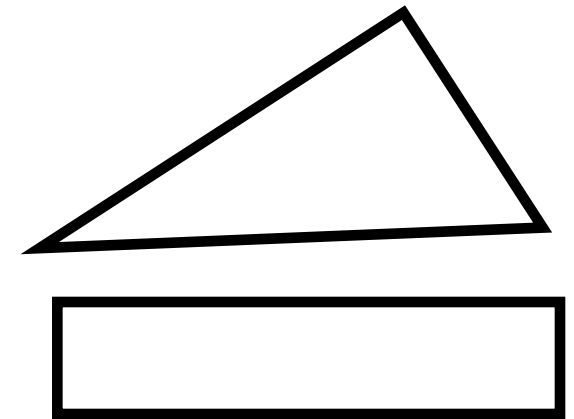
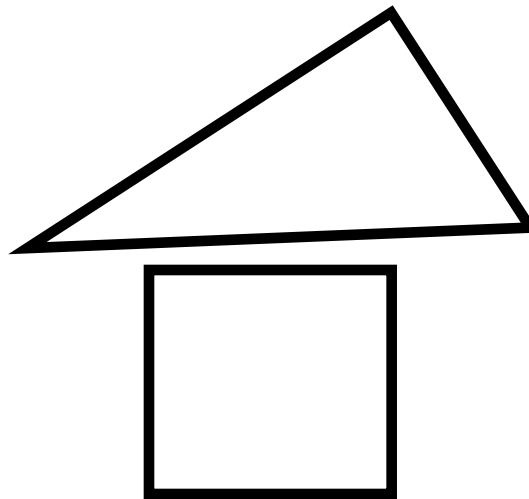
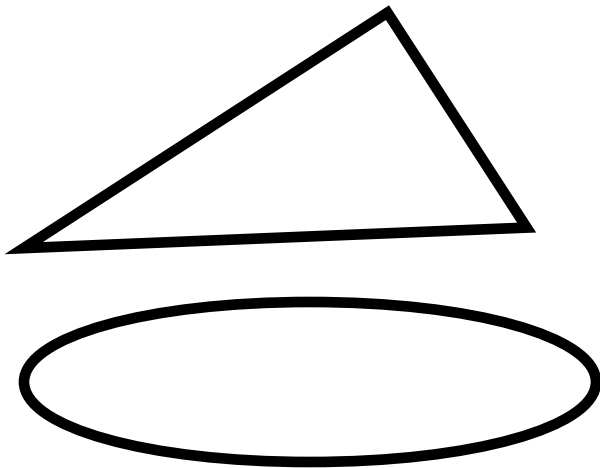
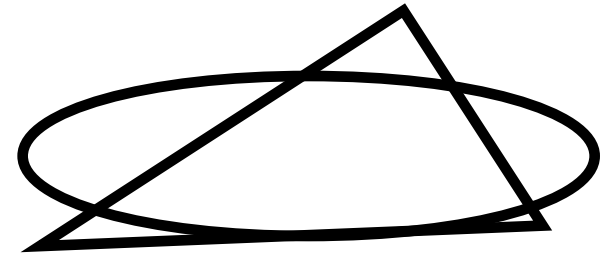
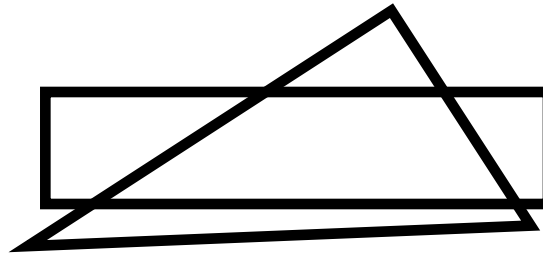
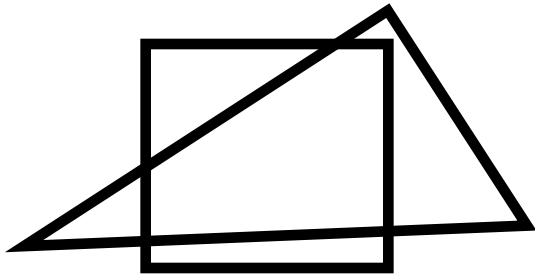

ASSOCIAZIONI LOGICHE
Associare le immagini secondo un legame logico.

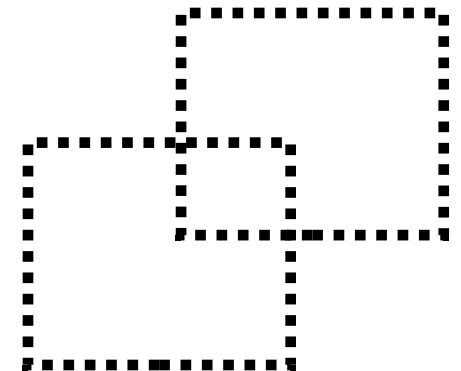
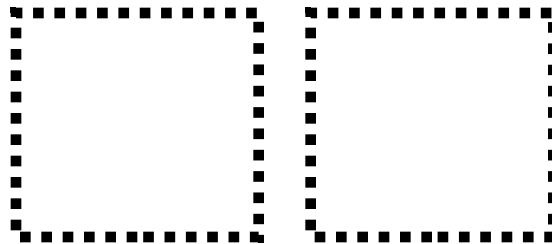
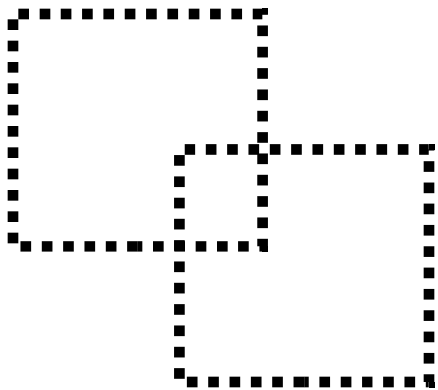
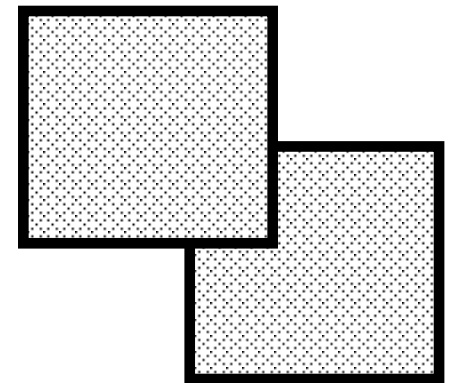
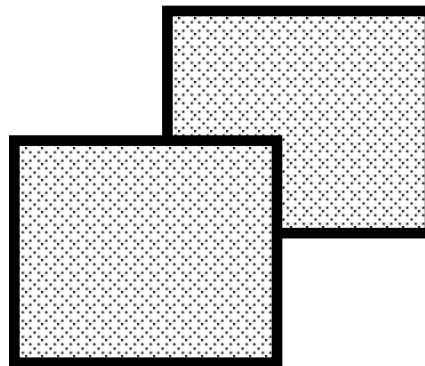
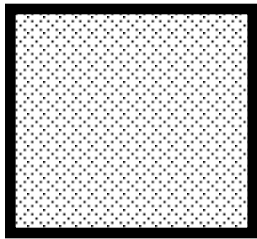
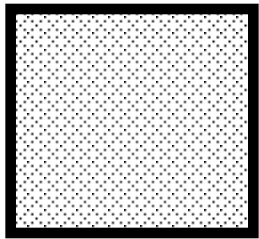

ASSOCIAZIONI LOGICHE

Associare le immagini secondo un legame logico.

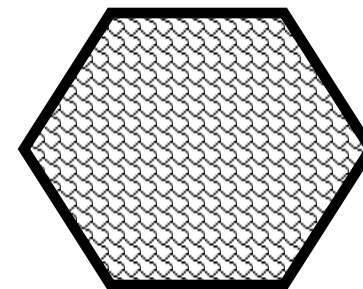
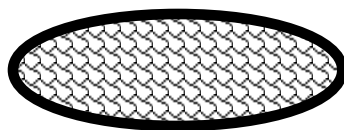
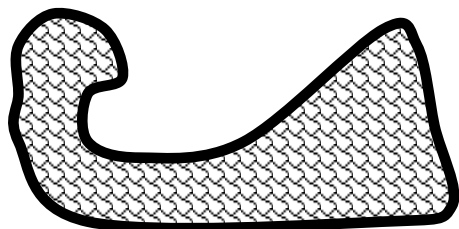
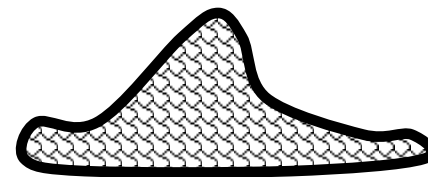
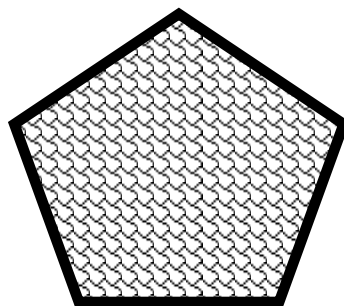
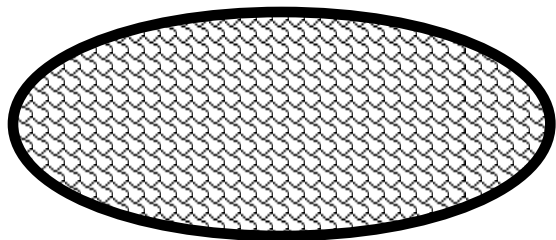

ASSOCIAZIONI LOGICHE
Associare le immagini secondo un legame logico.

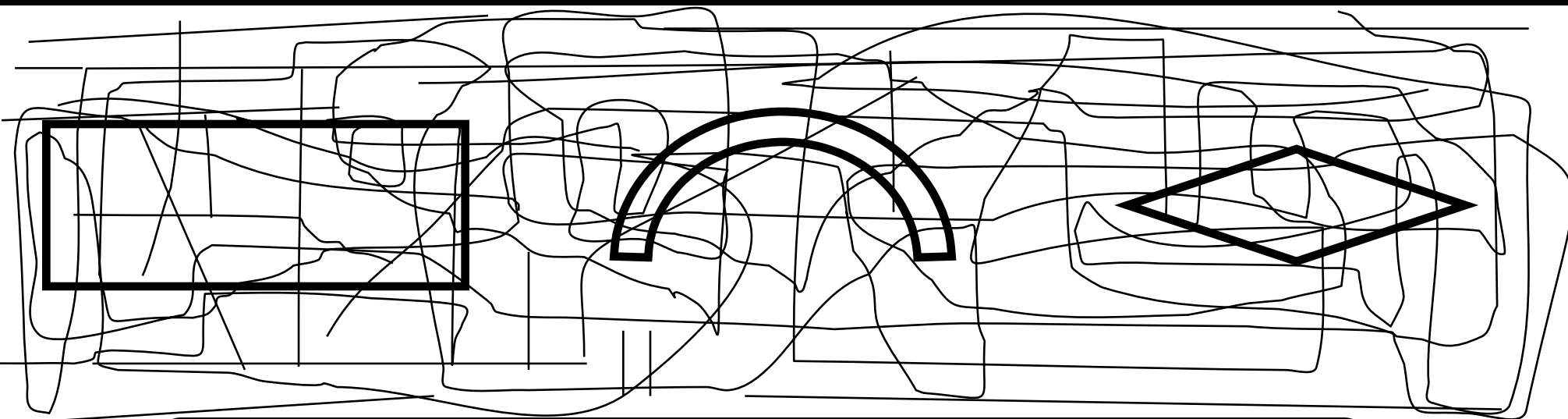
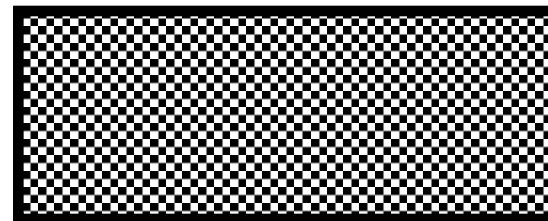
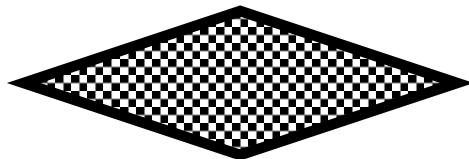
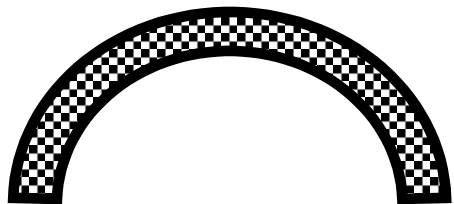

ASSOCIAZIONI LOGICHE

Associare le immagini secondo un legame logico.

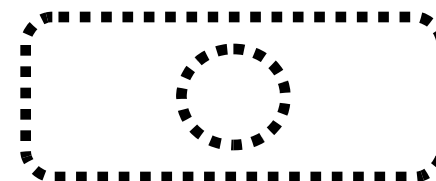
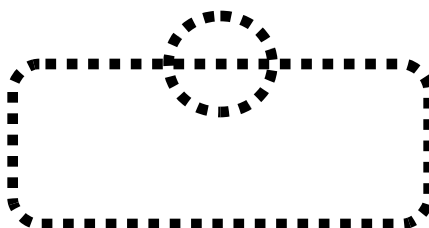
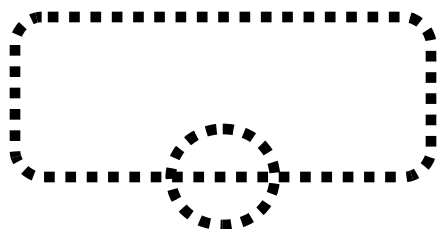
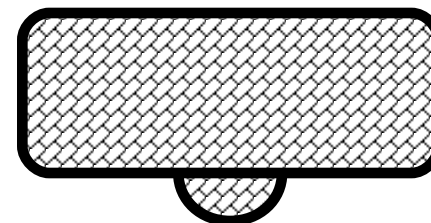
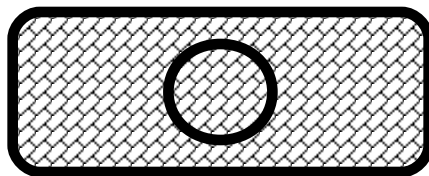
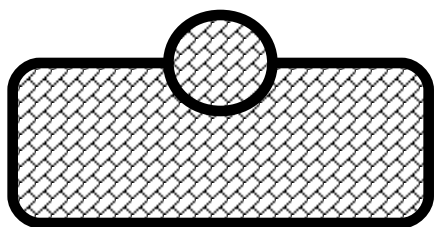

ASSOCIAZIONI LOGICHE
Associare le immagini secondo un legame logico.

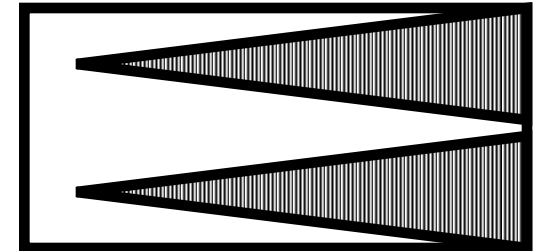
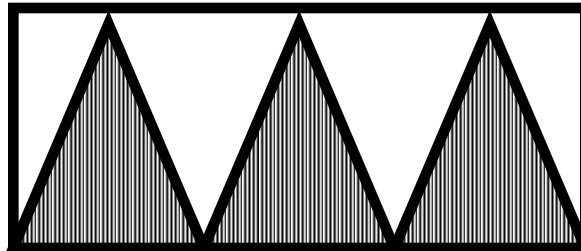
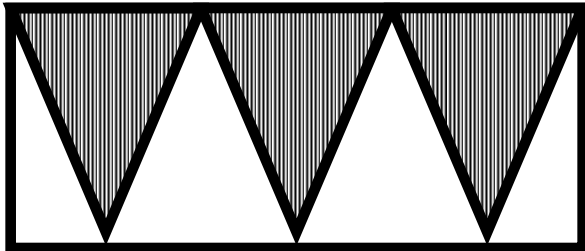
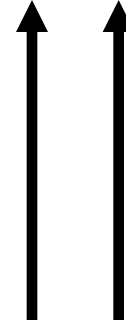
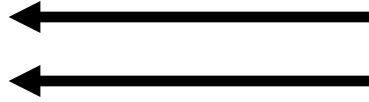
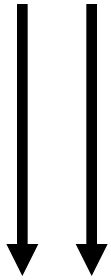

ASSOCIAZIONI LOGICHE

Associare le immagini secondo un legame logico.

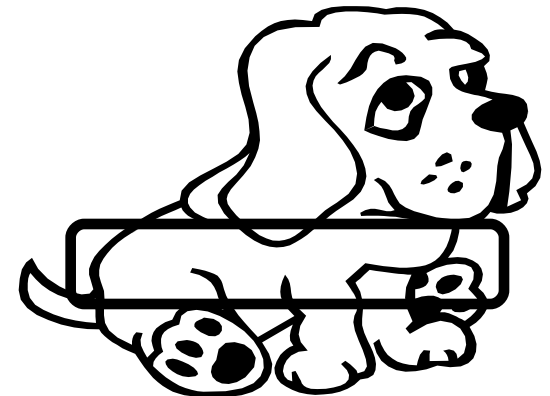
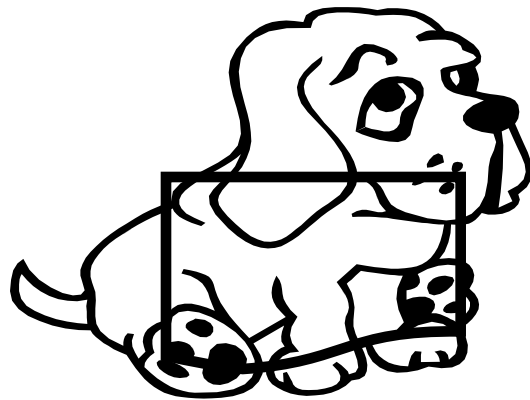
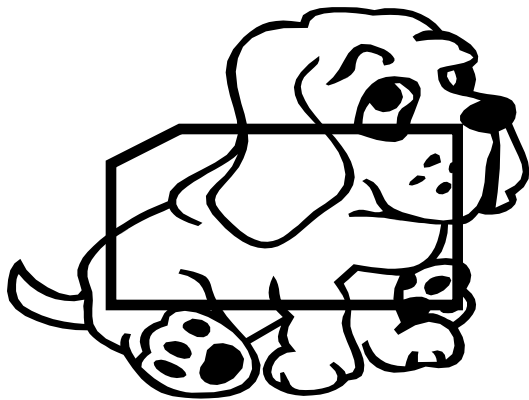
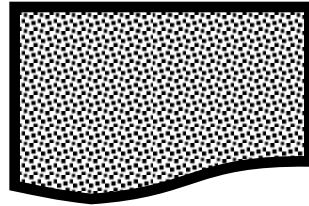
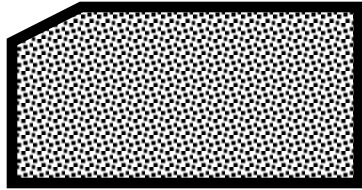

ASSOCIAZIONI LOGICHE

Associare le immagini secondo un legame logico.

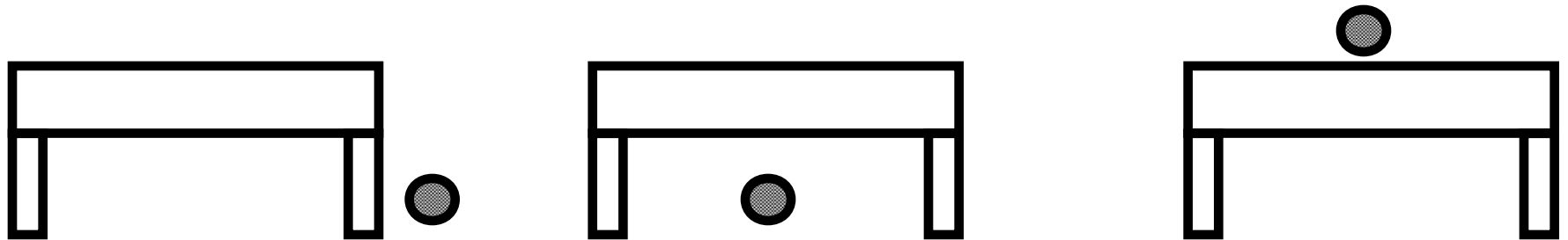
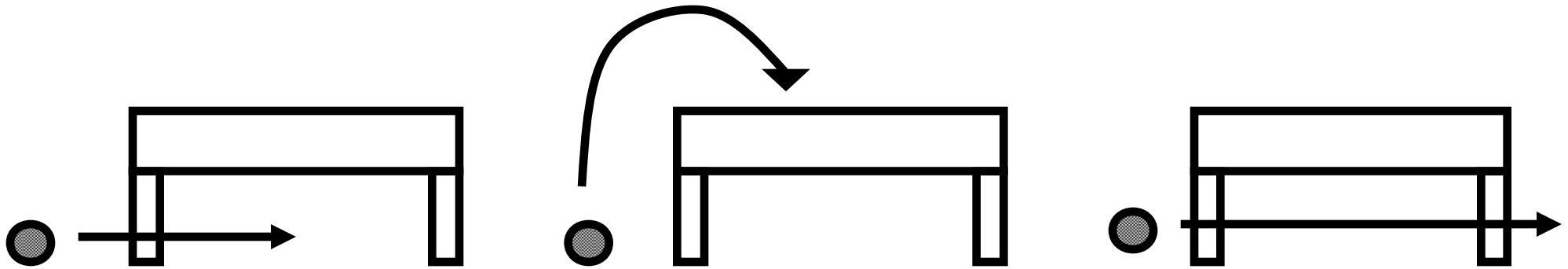

ASSOCIAZIONI LOGICHE
Associare le immagini secondo un legame logico.

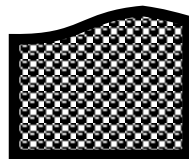
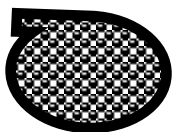
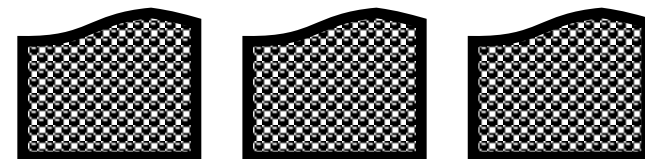
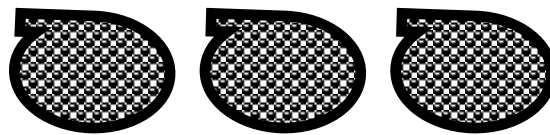
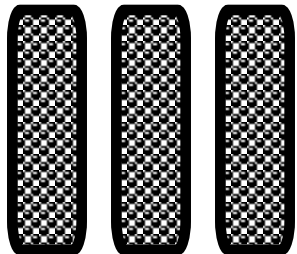

ASSOCIAZIONI LOGICHE
Associare le immagini secondo un legame logico.

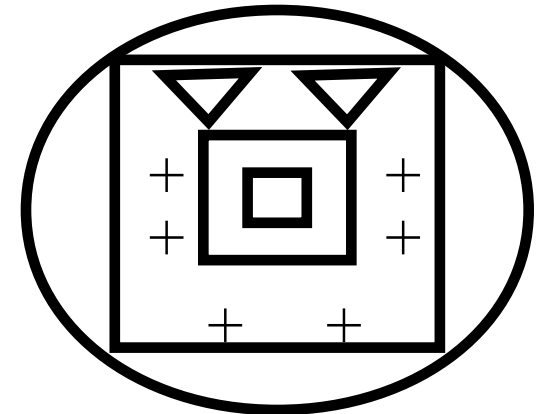
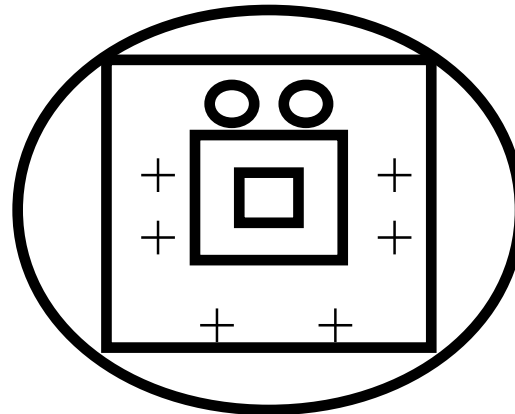
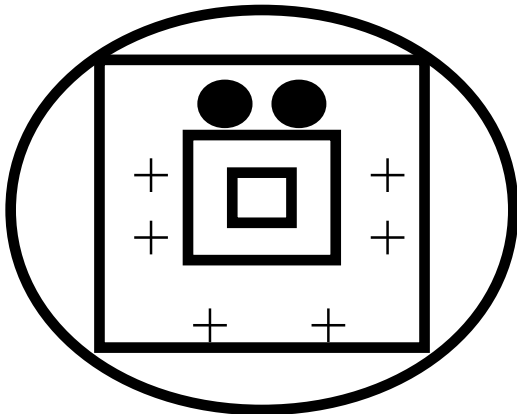
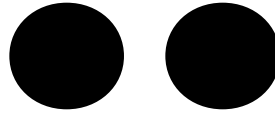

ASSOCIAZIONI LOGICHE
Associare le immagini secondo un legame logico.

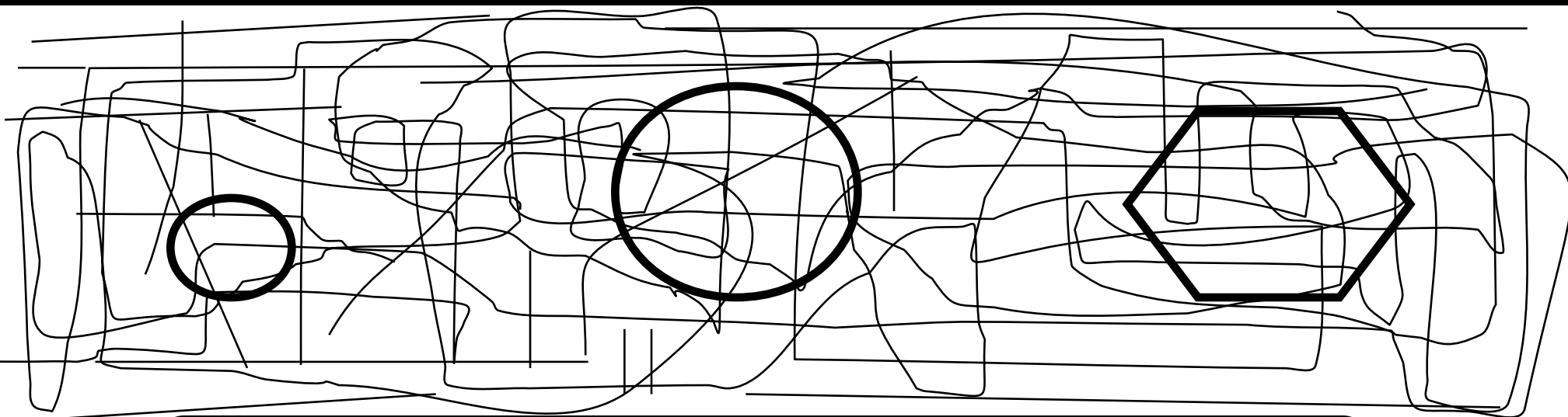
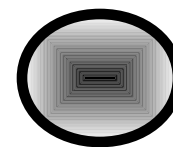
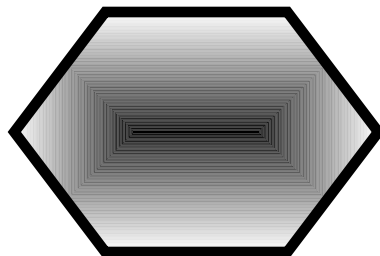
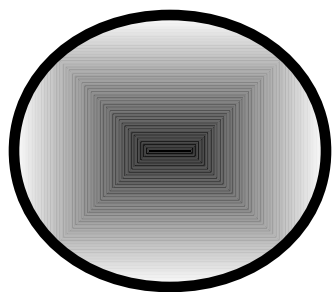

ASSOCIAZIONI LOGICHE

Associare le immagini secondo un legame logico.

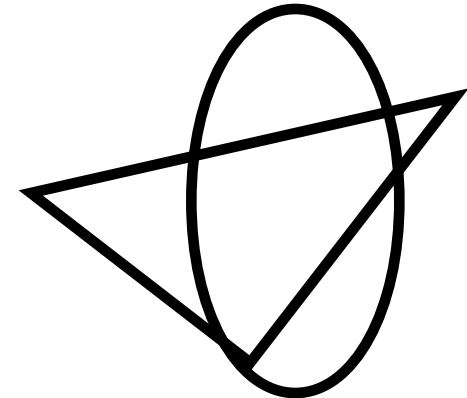
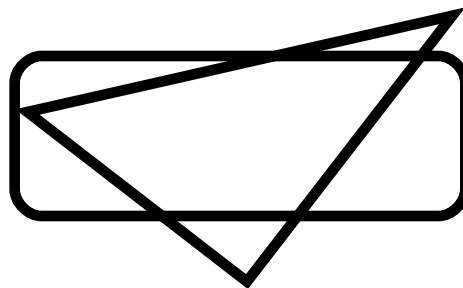
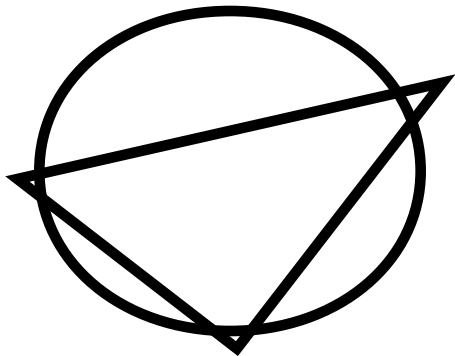
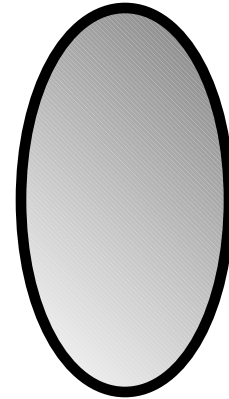
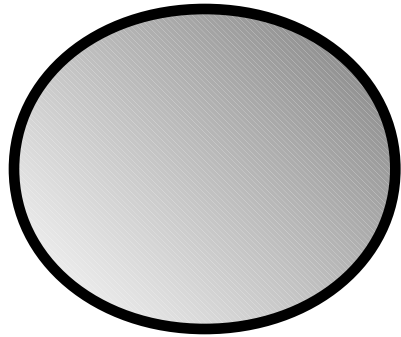

ASSOCIAZIONI LOGICHE

Associare le immagini secondo un legame logico.

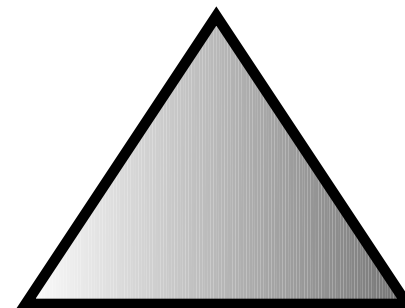
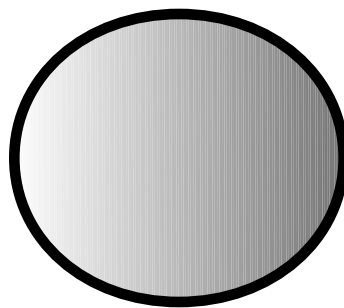
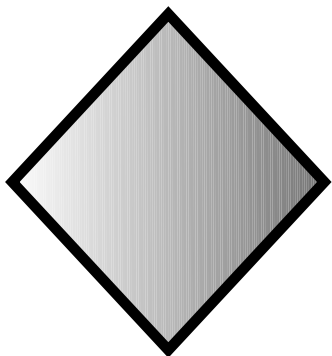
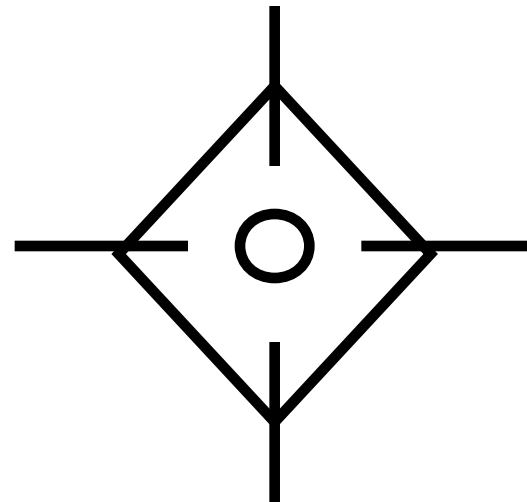
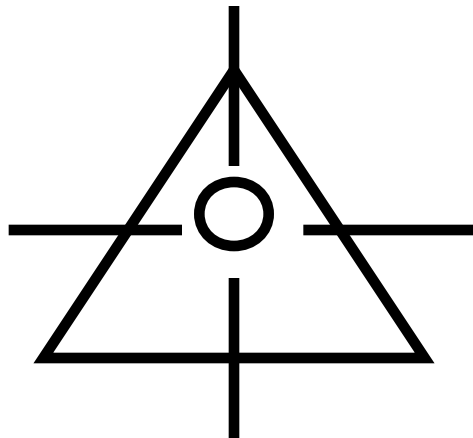
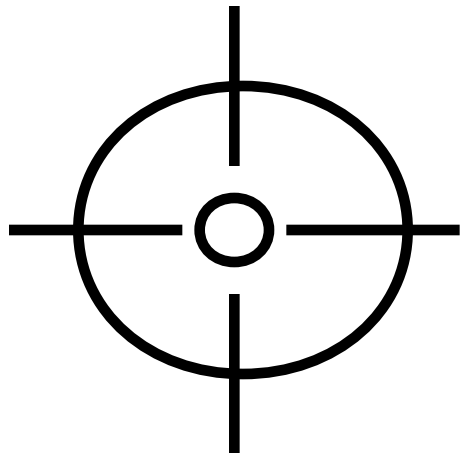

ASSOCIAZIONI LOGICHE
Associare le immagini secondo un legame logico.

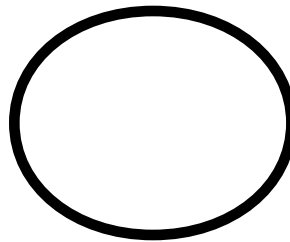
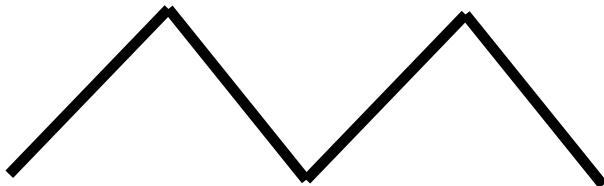
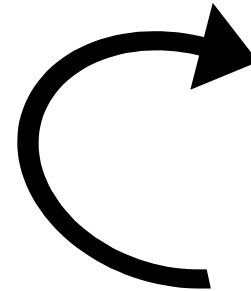
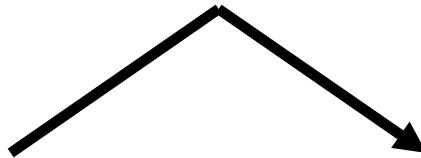

ASSOCIAZIONI LOGICHE

Associare le immagini secondo un legame logico.

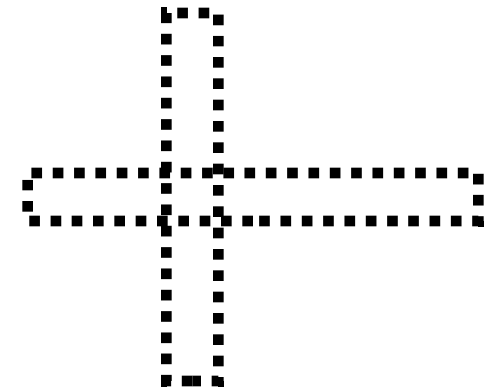
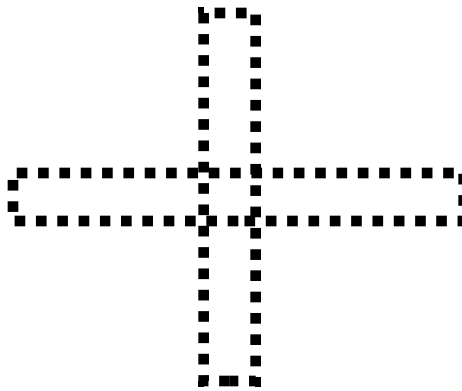
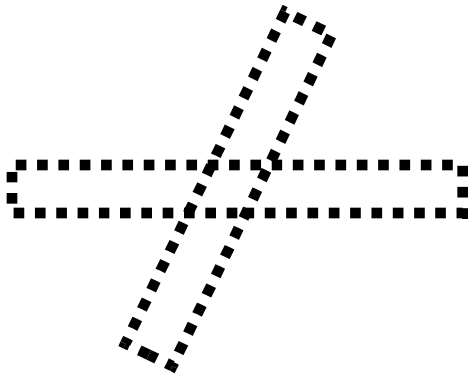
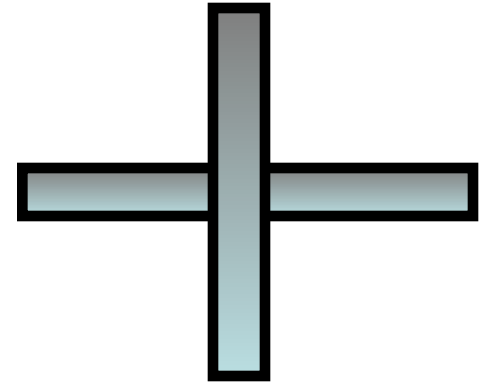
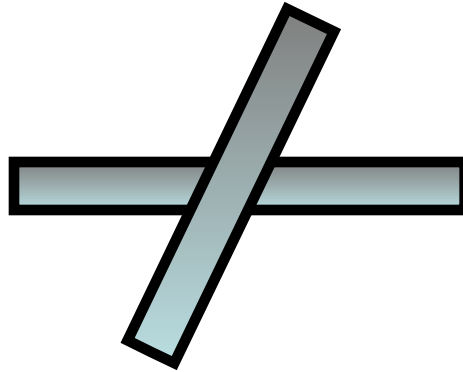
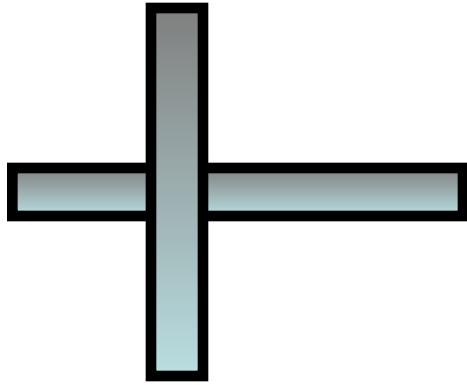

ASSOCIAZIONI LOGICHE

Associare le immagini secondo un legame logico.

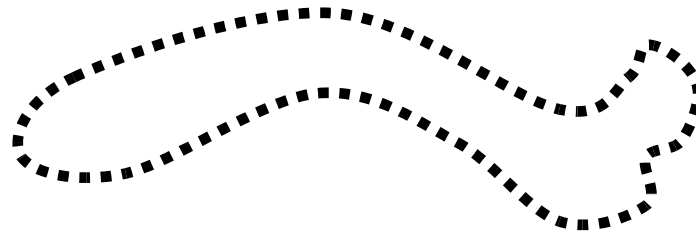
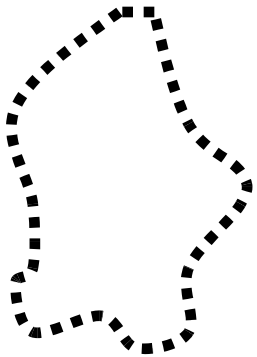
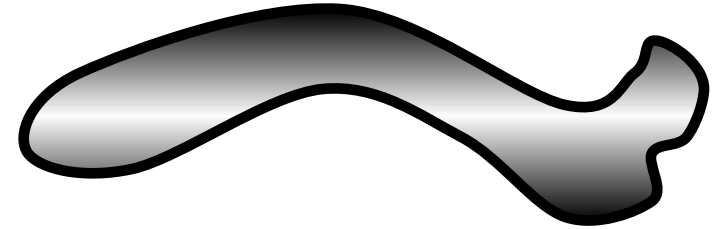
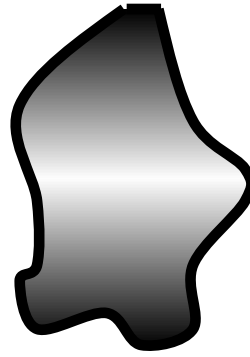
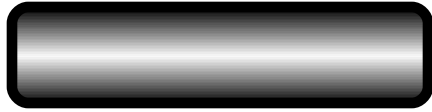

ASSOCIAZIONI LOGICHE

Associare le immagini secondo un legame logico.

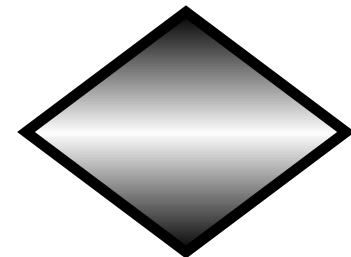
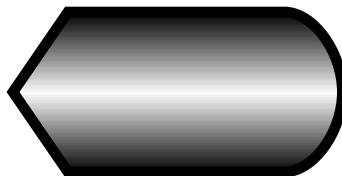
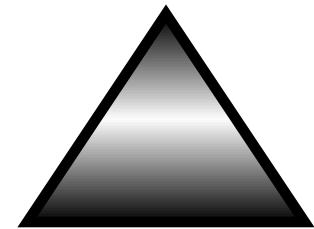
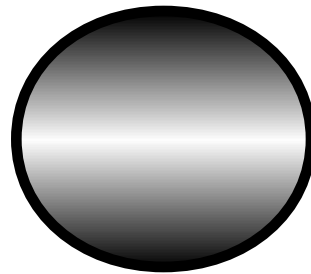
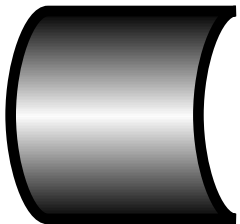
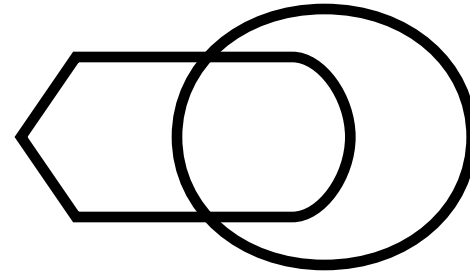
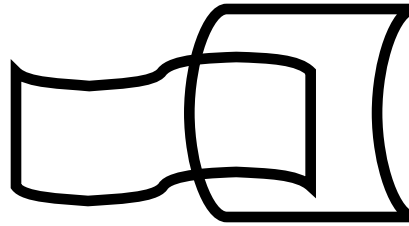
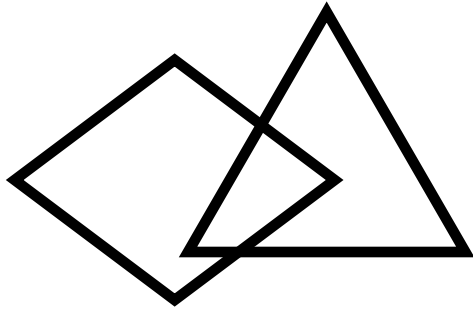

ASSOCIAZIONI LOGICHE

Associare le immagini secondo un legame logico.

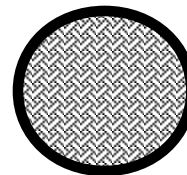
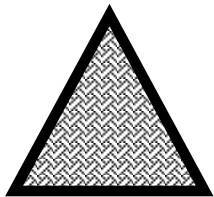
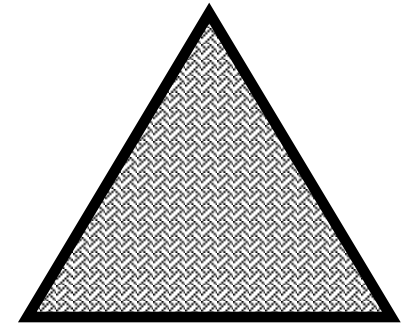
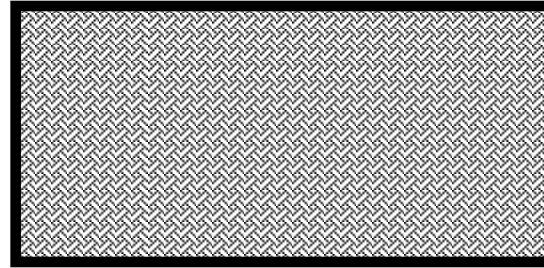
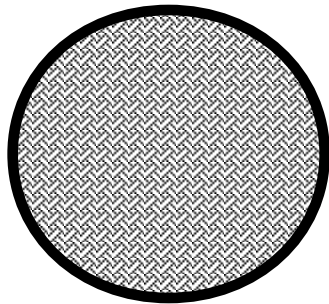

ASSOCIAZIONI LOGICHE
Associare le immagini secondo un legame logico.

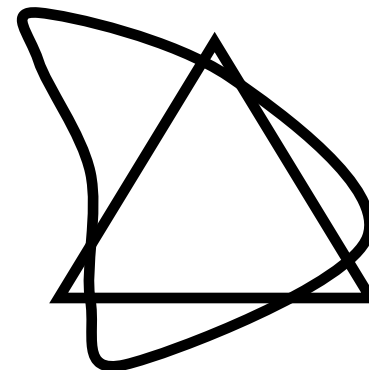
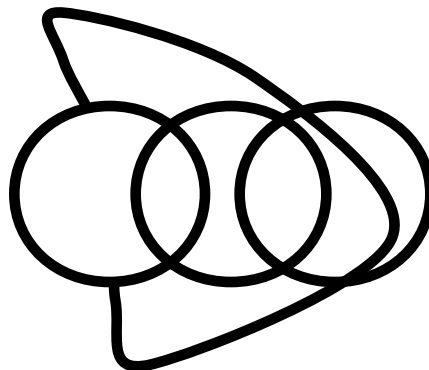
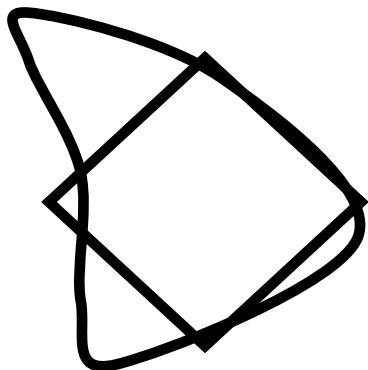
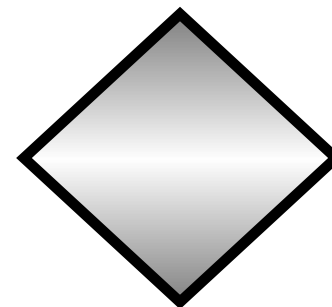
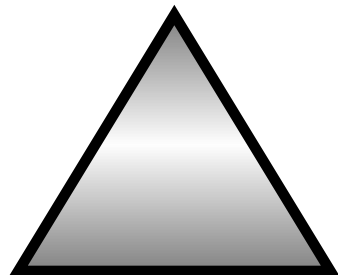
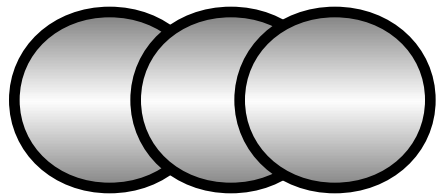

ASSOCIAZIONI LOGICHE

Associare le immagini secondo un legame logico.

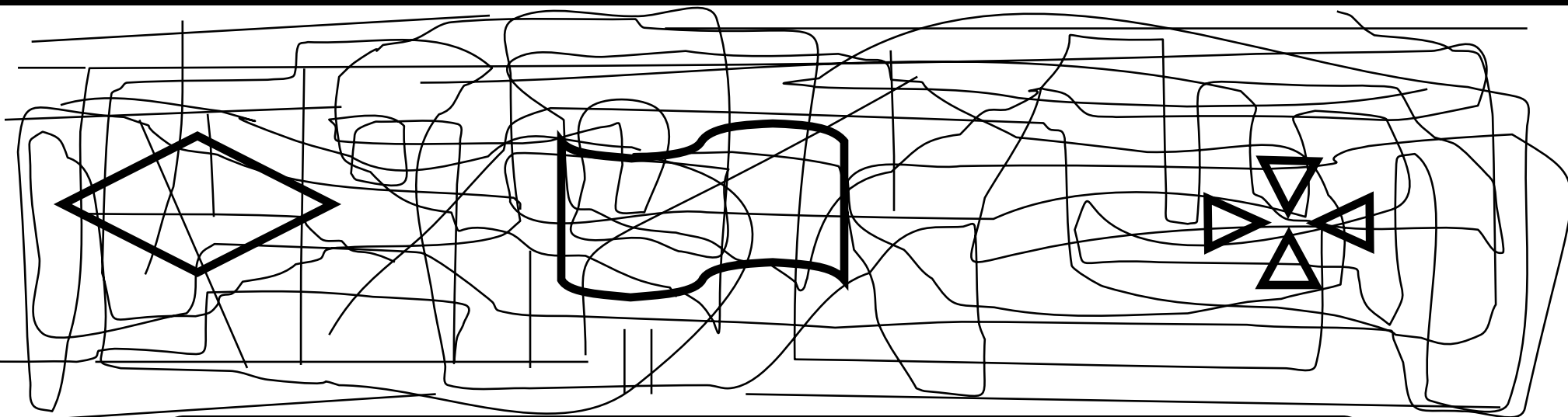
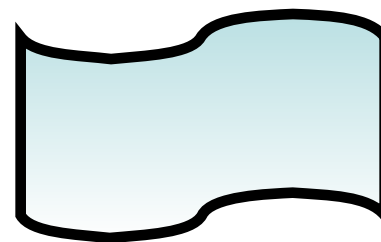
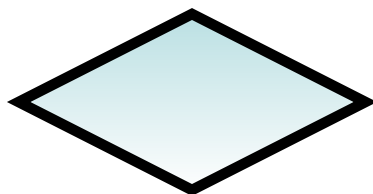
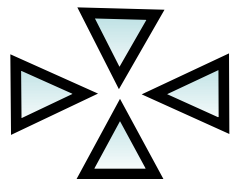

ASSOCIAZIONI LOGICHE

Associare le immagini secondo un legame logico.

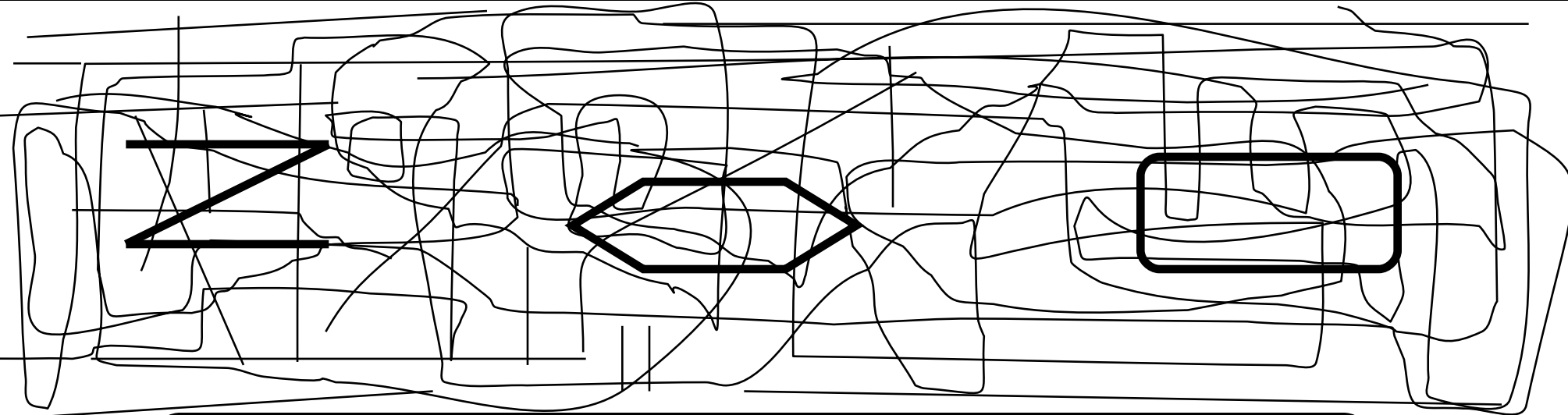
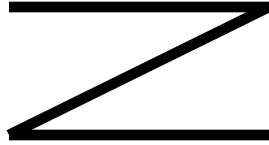

ASSOCIAZIONI LOGICHE

Associare le immagini secondo un legame logico.

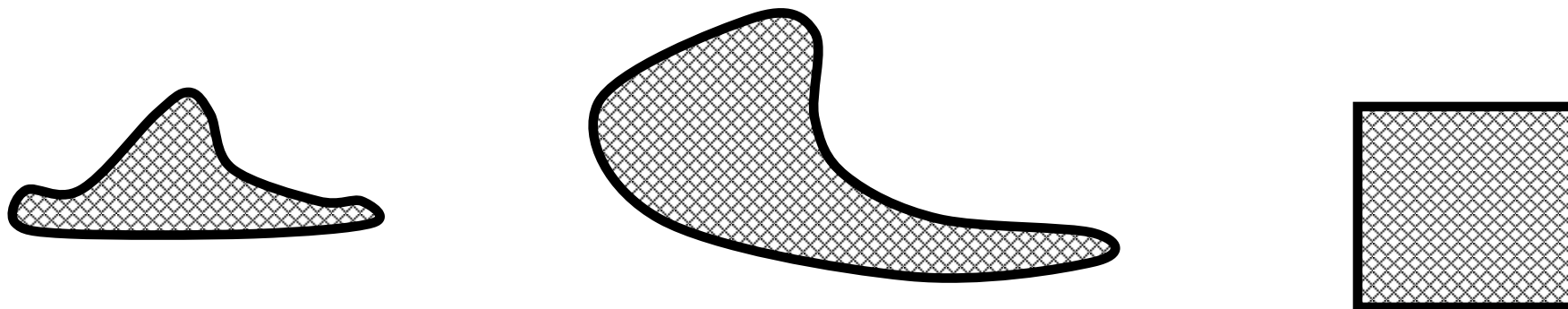
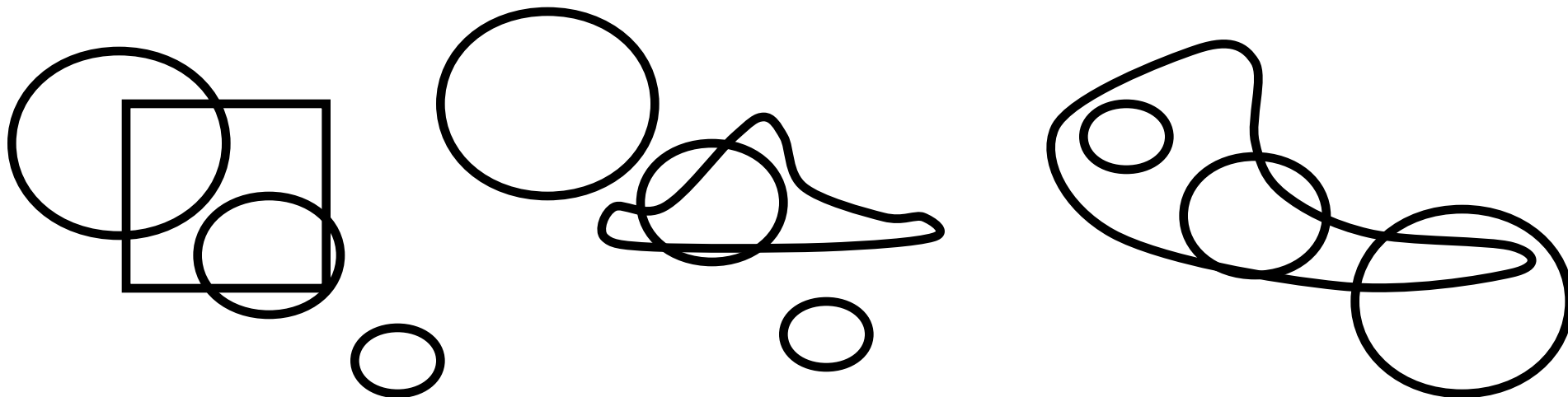

ASSOCIAZIONI LOGICHE

Associare le immagini secondo un legame logico.

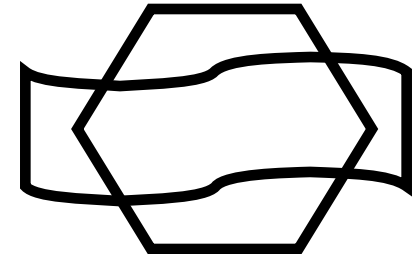
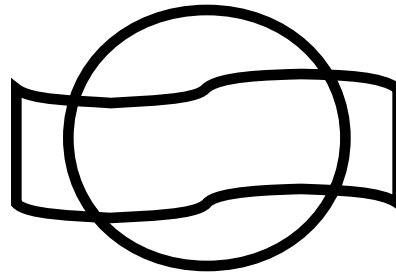
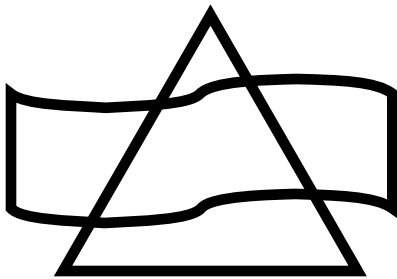
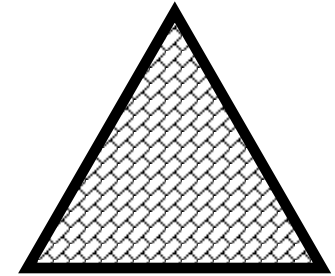
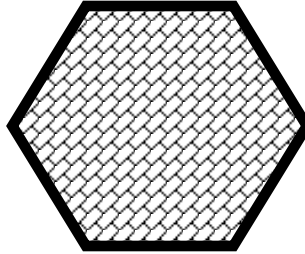
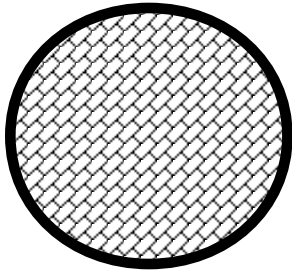

ASSOCIAZIONI LOGICHE
Associare le immagini secondo un legame logico.

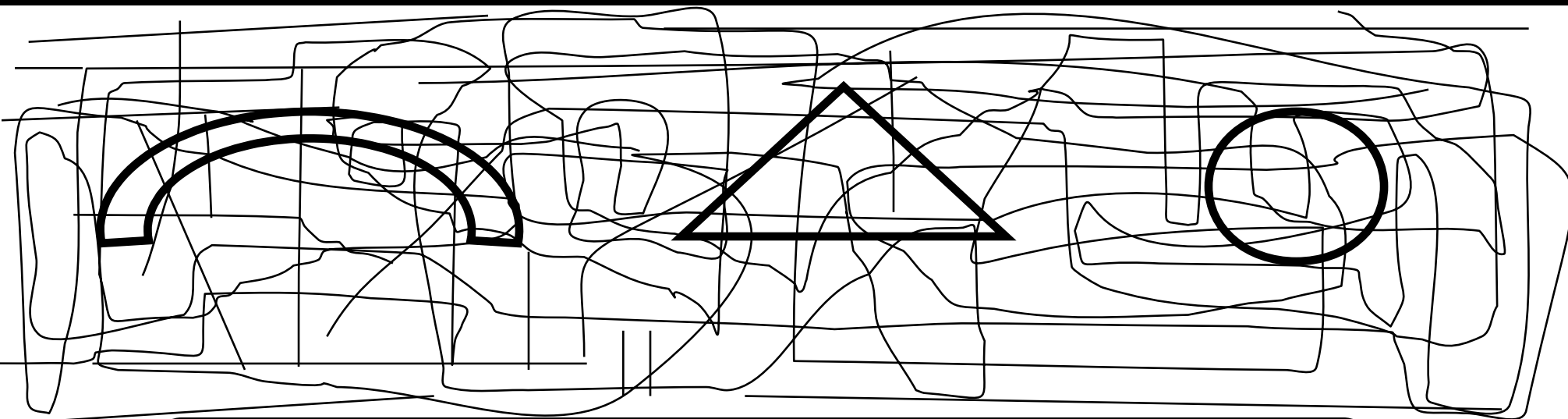
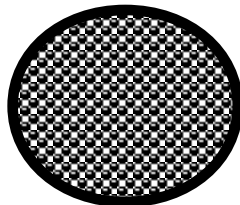
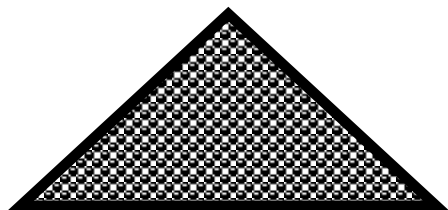

ASSOCIAZIONI LOGICHE

Associare le immagini secondo un legame logico.

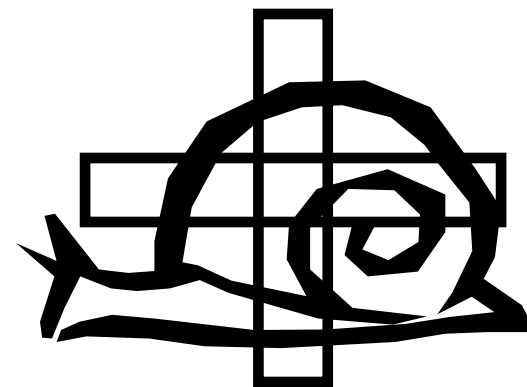
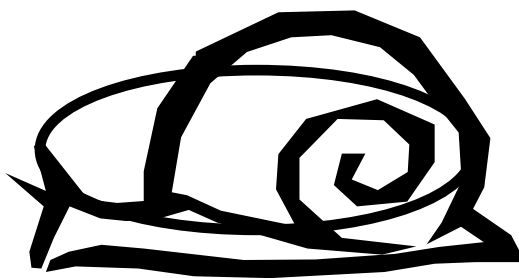
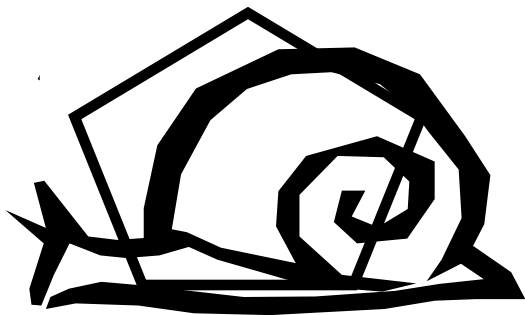
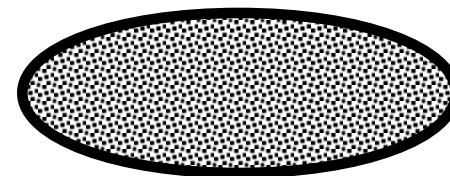
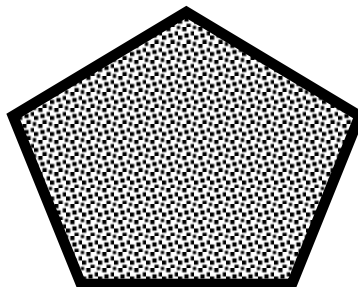
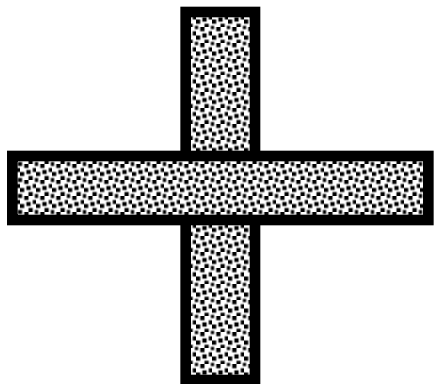

ASSOCIAZIONI LOGICHE

Associare le immagini secondo un legame logico.

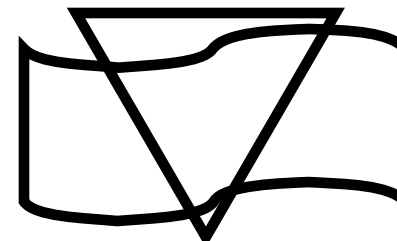
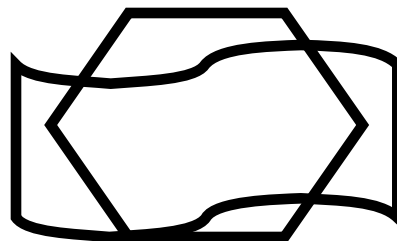
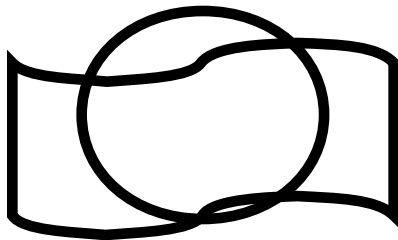
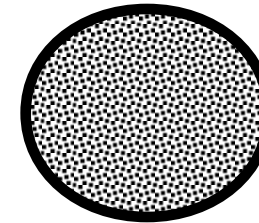
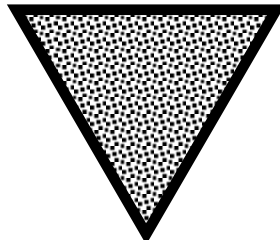
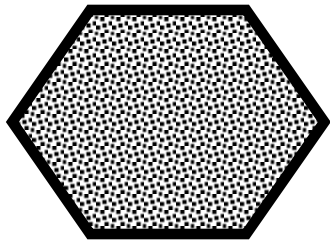

ASSOCIAZIONI LOGICHE

Associare le immagini secondo un legame logico.

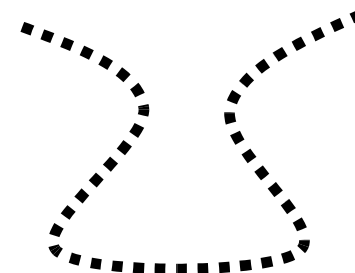
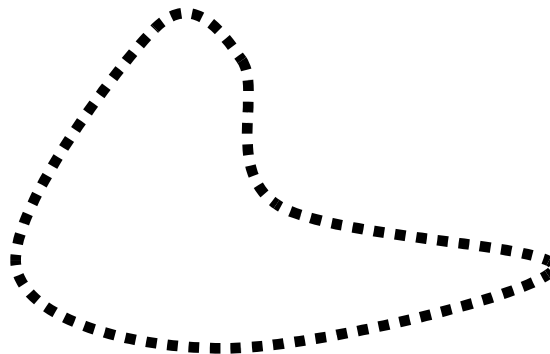
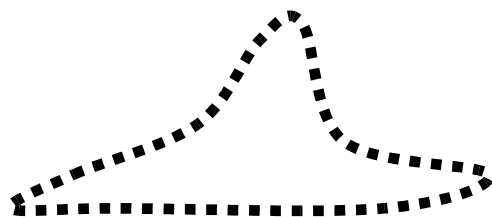
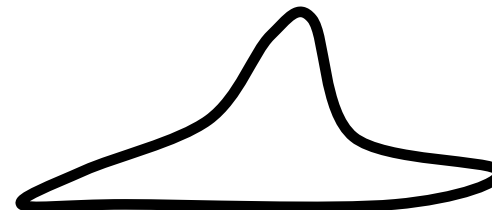
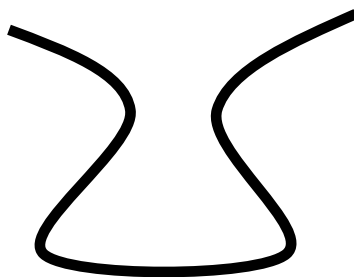
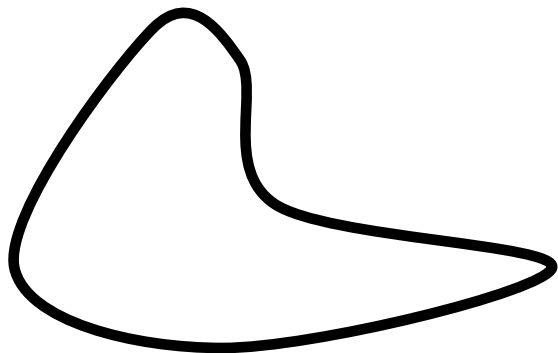

ASSOCIAZIONI LOGICHE

Associare le immagini secondo un legame logico.

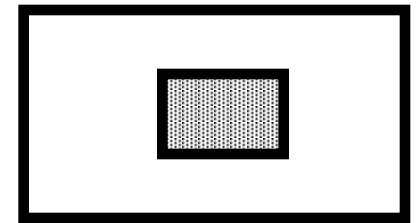
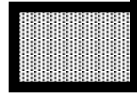
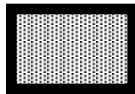
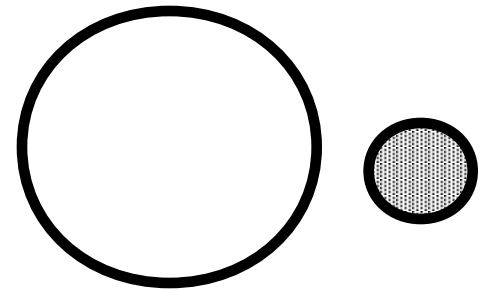
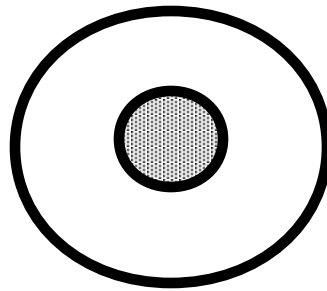
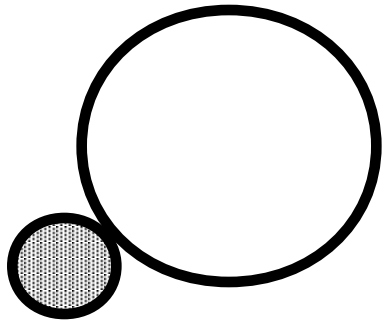

ASSOCIAZIONI LOGICHE
Associare le immagini secondo un legame logico.



ASSOCIAZIONI LOGICHE
Associare le immagini secondo un legame logico.

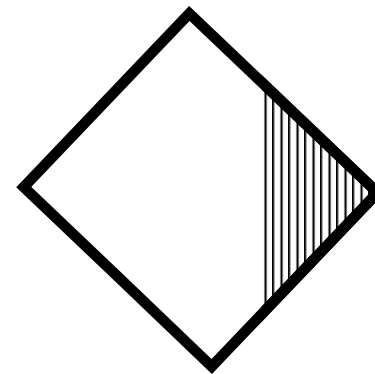
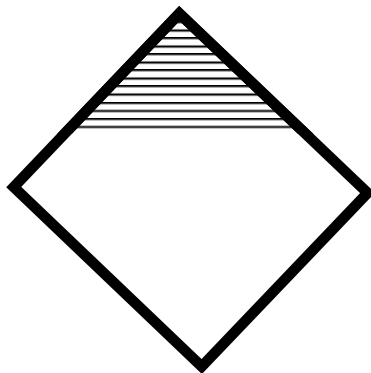
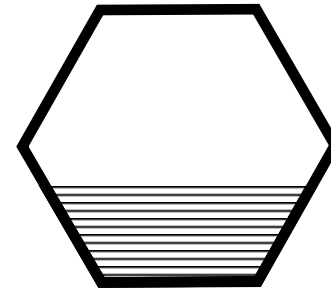
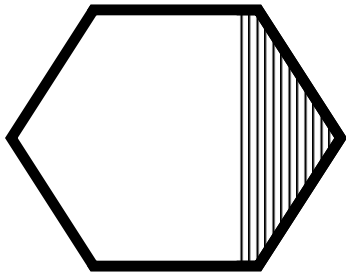

ASSOCIAZIONI LOGICHE
Associare le immagini secondo un legame logico.

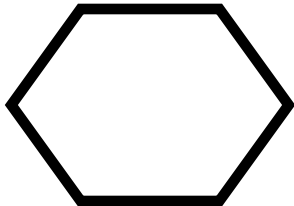
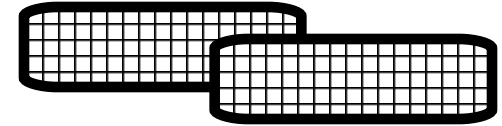
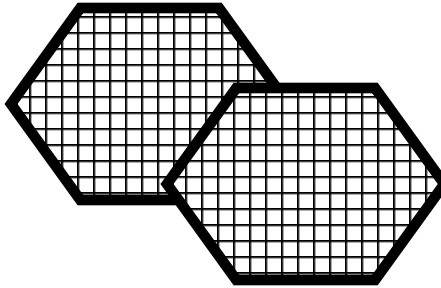
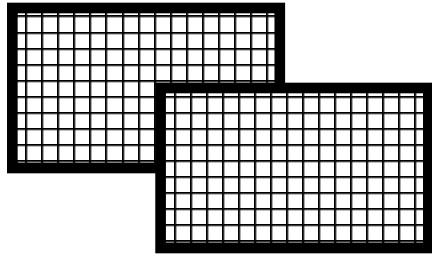

ASSOCIAZIONI LOGICHE
Associare le immagini secondo un legame logico.

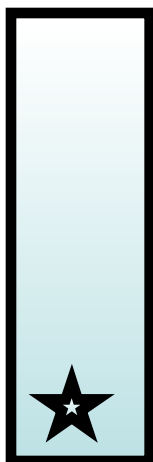
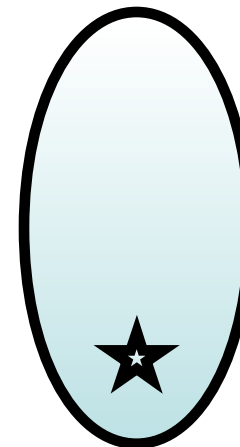
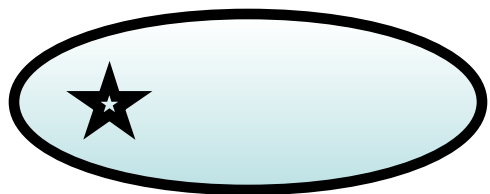

ASSOCIAZIONI LOGICHE
Associare le immagini secondo un legame logico.

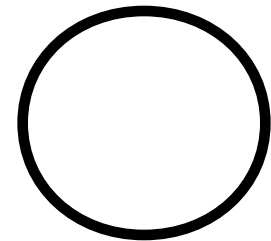
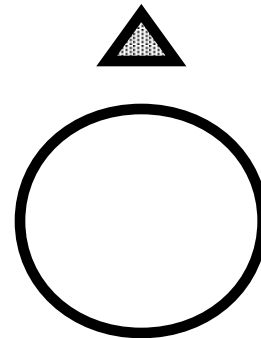
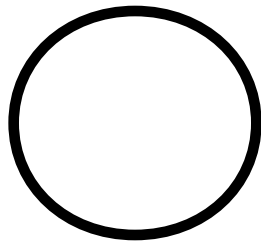
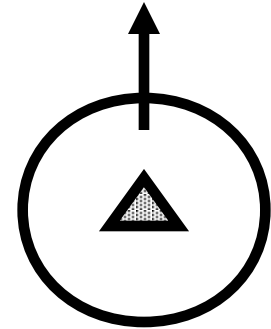
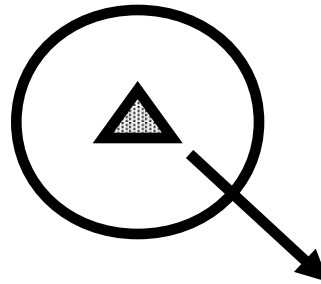
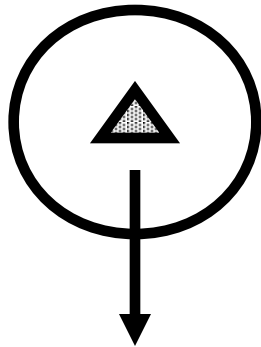

ASSOCIAZIONI LOGICHE

Associare le immagini secondo un legame logico.

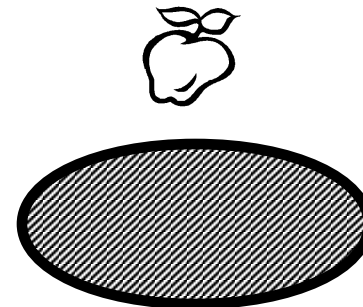
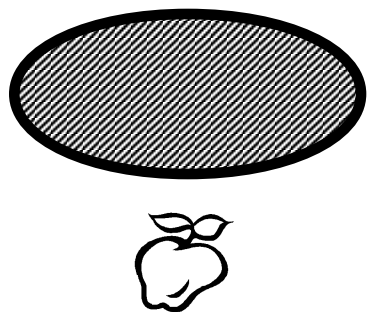
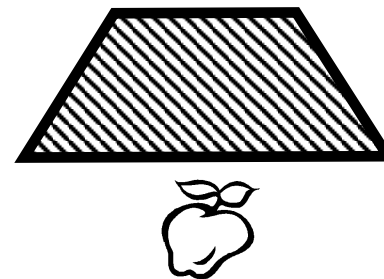
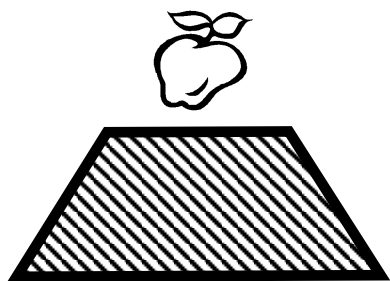

ASSOCIAZIONI LOGICHE
Associare le immagini secondo un legame logico.

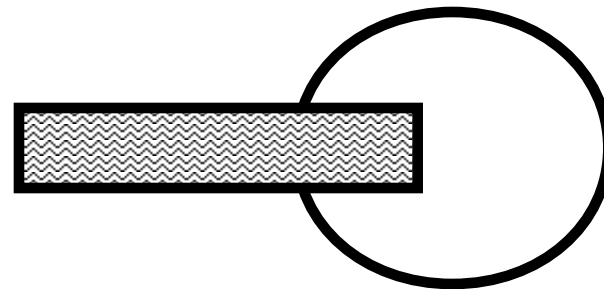
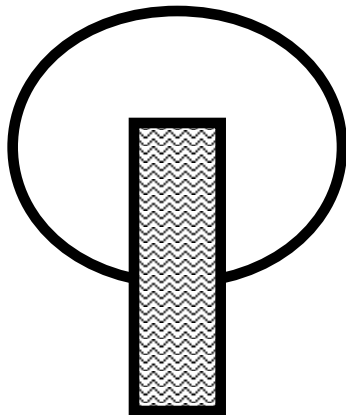
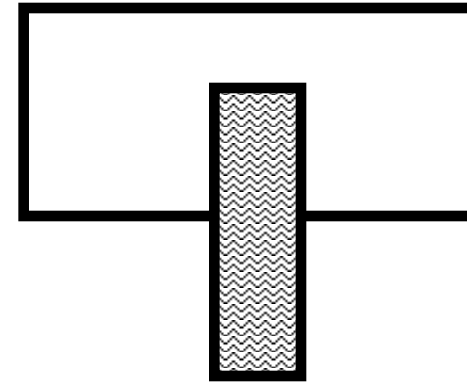
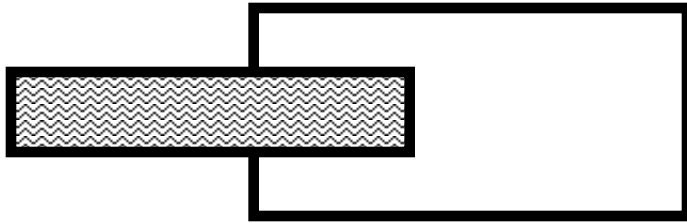

ASSOCIAZIONI LOGICHE
Associare le immagini secondo un legame logico.

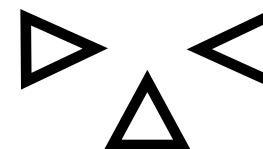
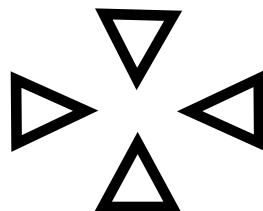
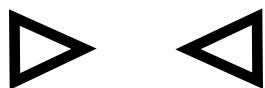
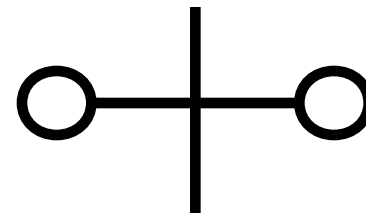
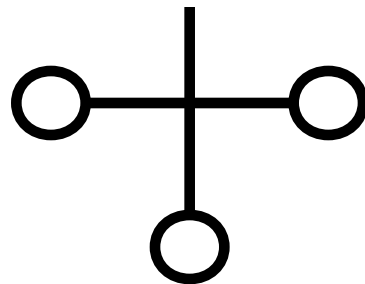
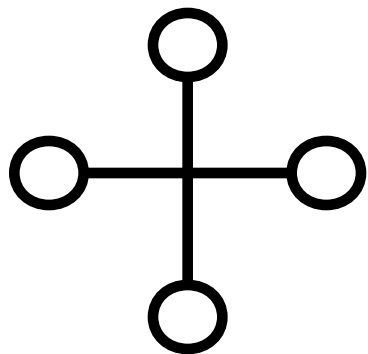

ASSOCIAZIONI LOGICHE
Associare le immagini secondo un legame logico.

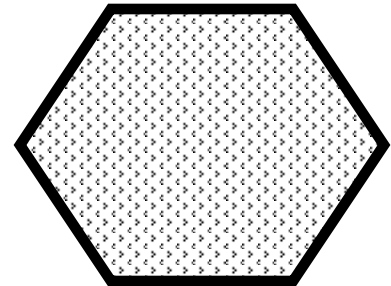
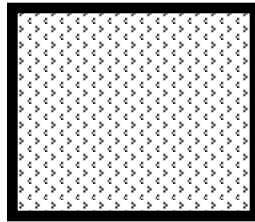
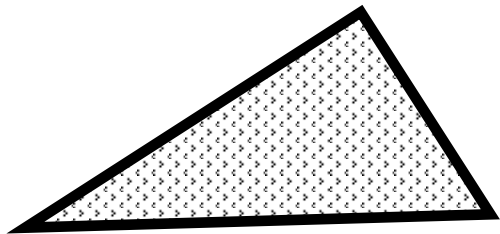
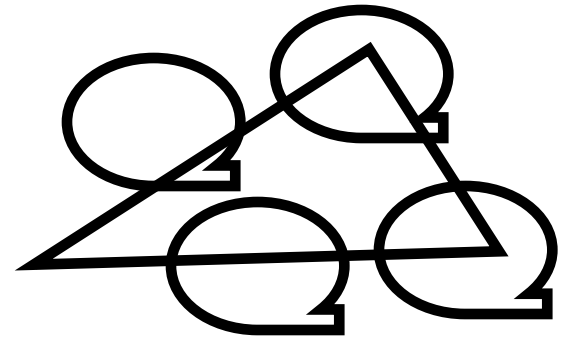
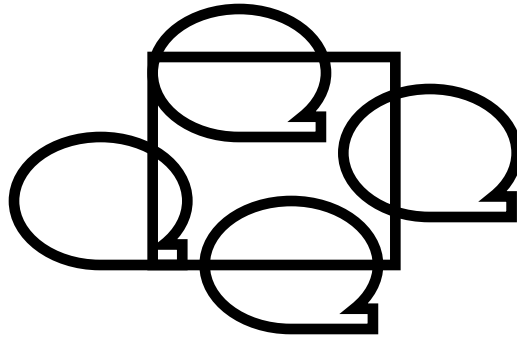
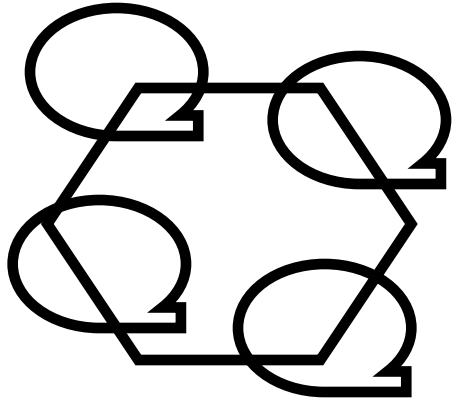

ASSOCIAZIONI LOGICHE
Associare le immagini secondo un legame logico.

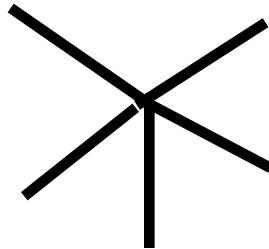
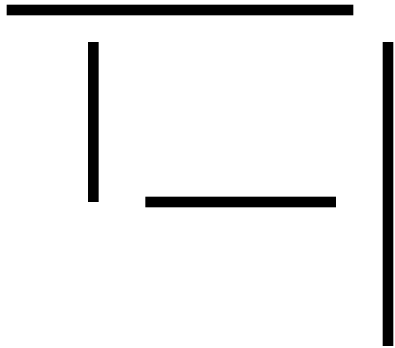
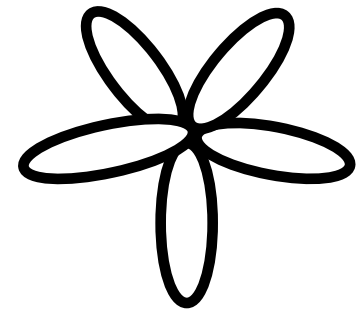
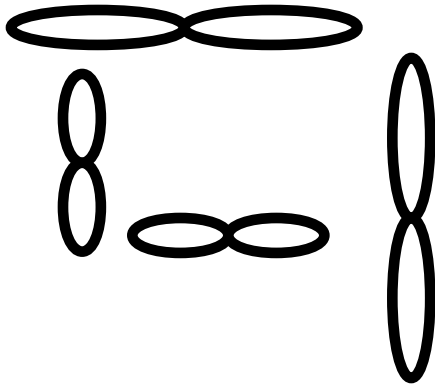
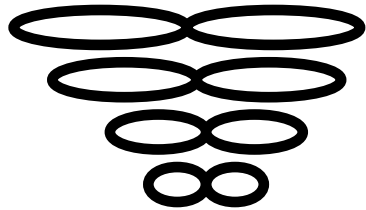

ASSOCIAZIONI LOGICHE

Associare le immagini secondo un legame logico.

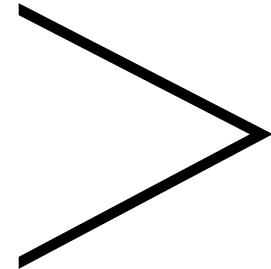
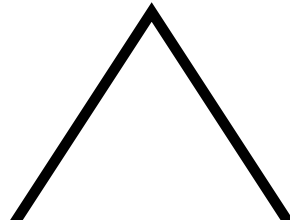
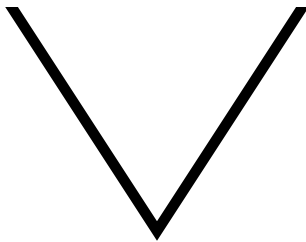
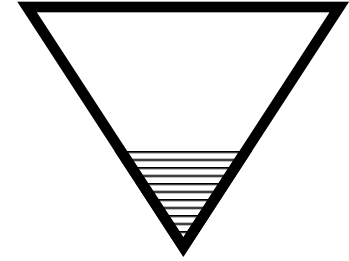
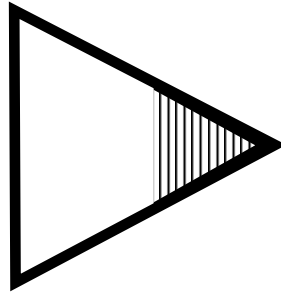
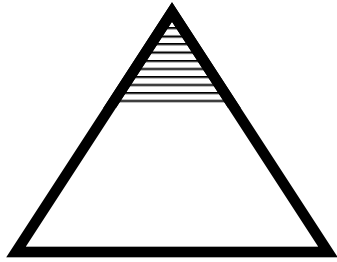

ASSOCIAZIONI LOGICHE
Associare le immagini secondo un legame logico.

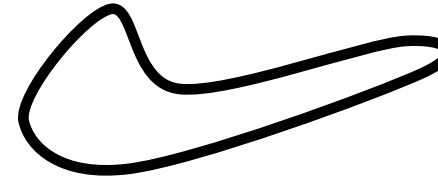
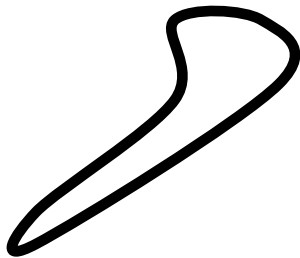
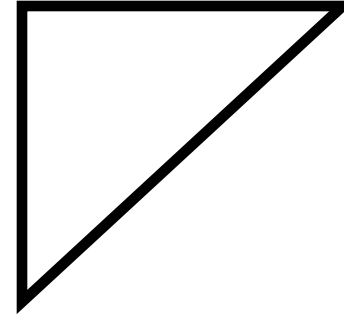
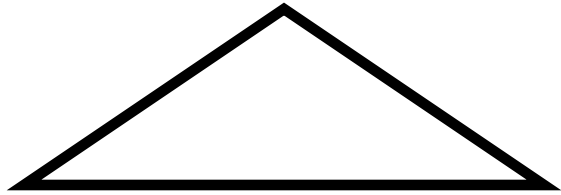

ASSOCIAZIONI LOGICHE

Associare le immagini secondo un legame logico.

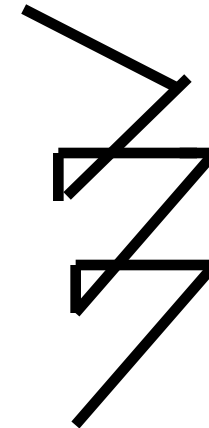
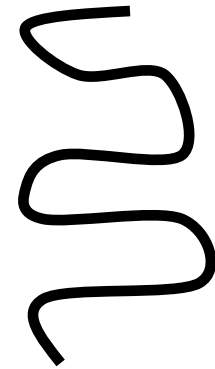
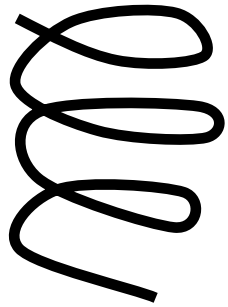

ASSOCIAZIONI LOGICHE

Associare le immagini secondo un legame logico.

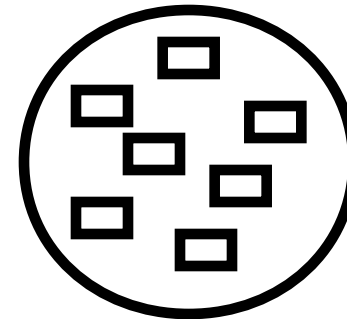
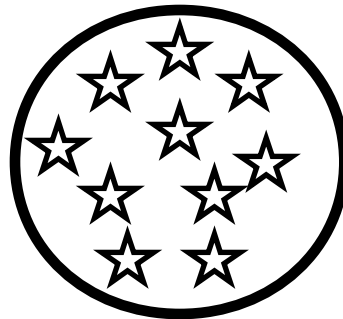
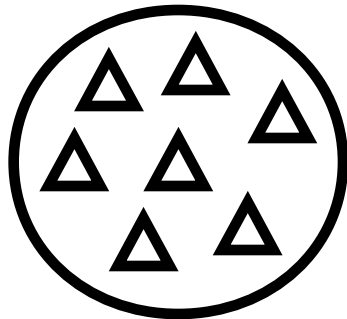

ASSOCIAZIONI LOGICHE
Associare le immagini secondo un legame logico.

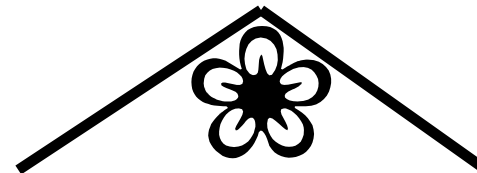
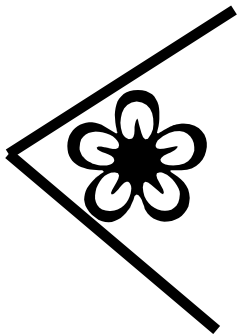
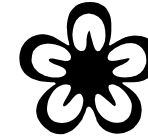
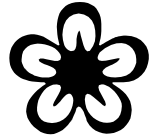

ASSOCIAZIONI LOGICHE

Associare le immagini secondo un legame logico.

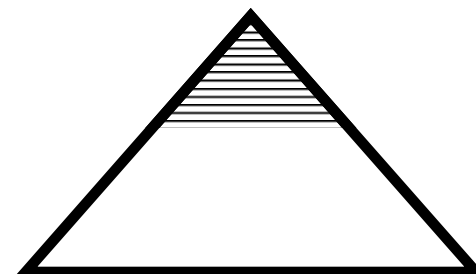
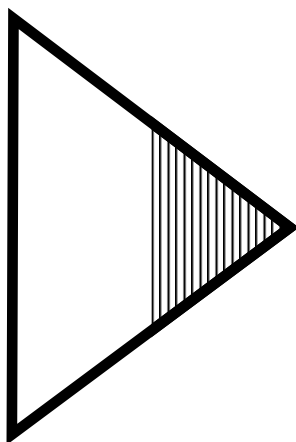
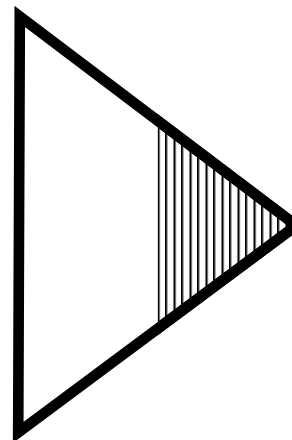
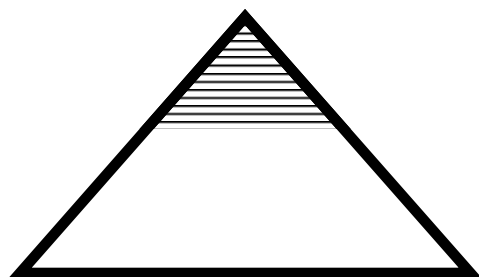

ASSOCIAZIONI LOGICHE

Associare le immagini secondo un legame logico.

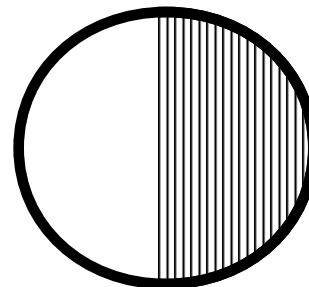
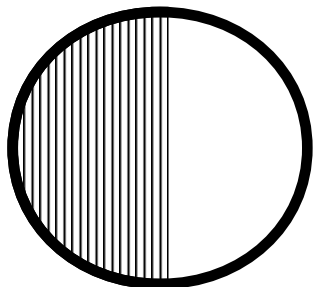
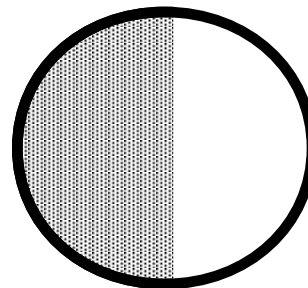
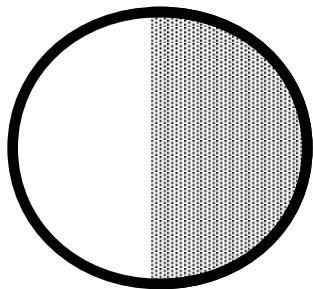

ASSOCIAZIONI LOGICHE

Associare le immagini secondo un legame logico.

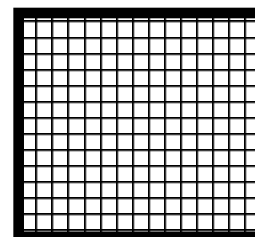
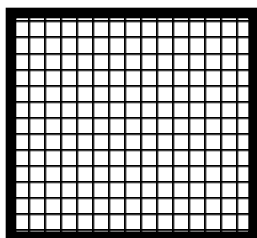
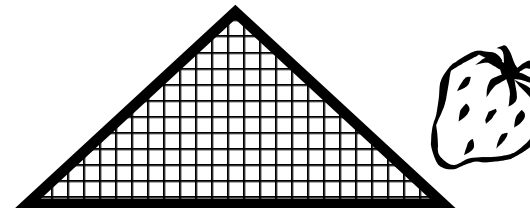
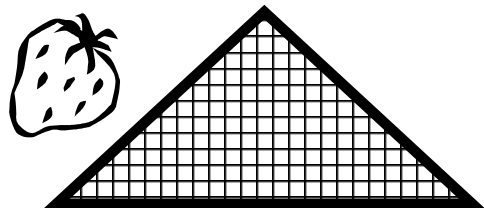

ASSOCIAZIONI LOGICHE

Associare le immagini secondo un legame logico.

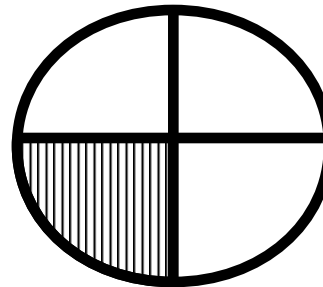
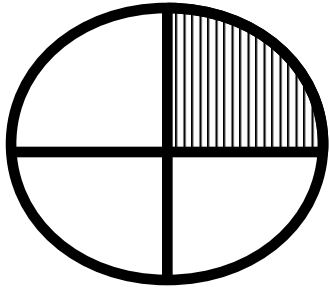
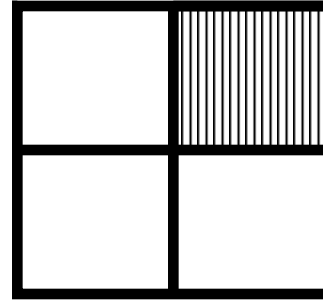
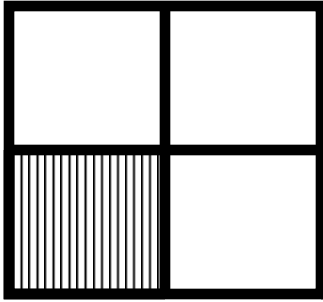

ASSOCIAZIONI LOGICHE
Associare le immagini secondo un legame logico.

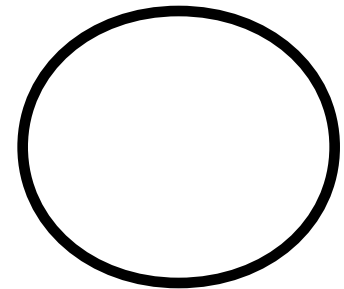
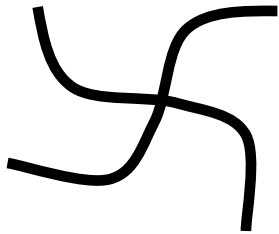
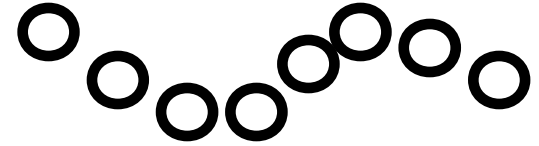
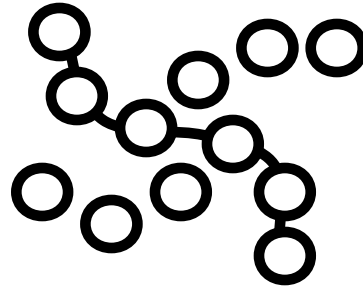
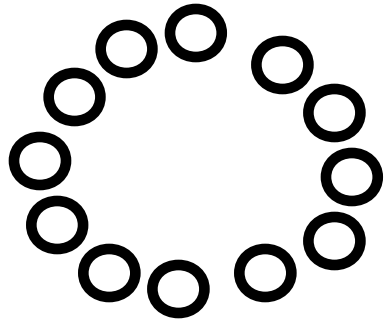

ASSOCIAZIONI LOGICHE

Associare le immagini secondo un legame logico.