

# SVILUPPO LOGICO E PERCETTIVO

*Emidio Tribulato*



Volume 5

**Emidio Tribulato**

# SVILUPPO LOGICO E PERCETTIVO

**Volume quinto**

Stampare a colori da pagina 72 a pagina 78.

Centro studi *LOGOS* – ONLUS - Messina



2010- Tutti i diritti riservati.

Sito web: [www.cslogos.it](http://www.cslogos.it) – E - mail: [postmaster@cslogos.it](mailto:postmaster@cslogos.it)

## **ASSOCIAZIONI LOGICHE**

L'attività di associare un oggetto, un animale, un vegetale o una forma geometrica ad un altro, ricercando un possibile legame logico di uso, funzione, forma, posizione nello spazio, somiglianza, causa - effetto, parte - tutto ecc. implica la stimolazione di processi di astrazione, classificazione ed organizzazione spaziale, basilari per lo sviluppo intellettuale.

### **UTILIZZAZIONE**

Per utilizzare tali schede basta indicare al bambino l'immagine presente nella parte sinistra, chiedendo di associarla con un'altra disegnata nella parte destra. Nei bambini sordi, si cercherà di utilizzare il segno mimico che significa legame. Dopo che il bambino avrà effettuato l'associazione l'educatore chiarirà il motivo che lo ha spinto ad effettuare tale scelta.

### **VERBALIZZAZIONE**

1<sup>a</sup> Fase

Inizialmente per questa attività chiederemo al bambino solo il nome degli oggetti che si associano.

2<sup>a</sup> Fase.

In un secondo momento, sarà il bambino stesso ad esplicitare il motivo che lo ha spinto ad effettuare quell'associazione.

### **ETA' DI RIFERIMENTO**

Cinque anni nello sviluppo logico.

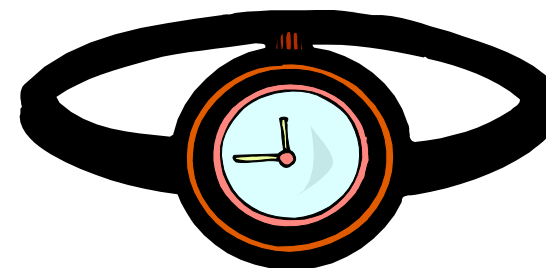
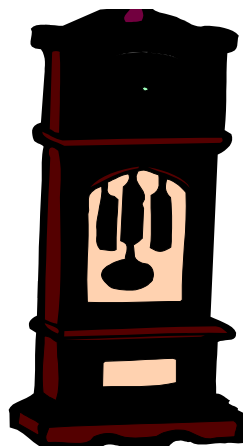
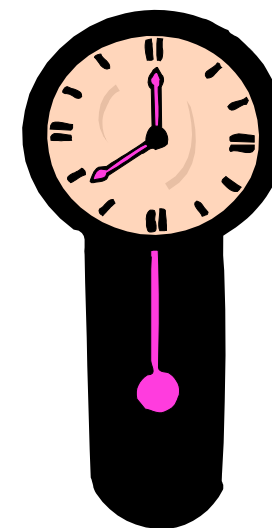
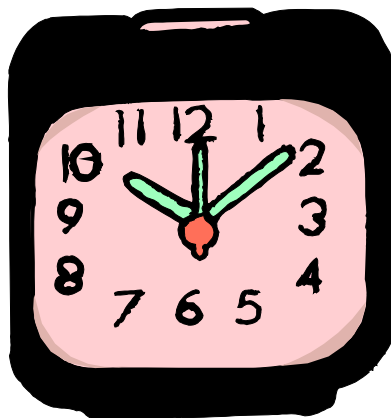

## ASSOCIAZIONI LOGICHE

Far denominare e associare le immagini secondo un legame logico.

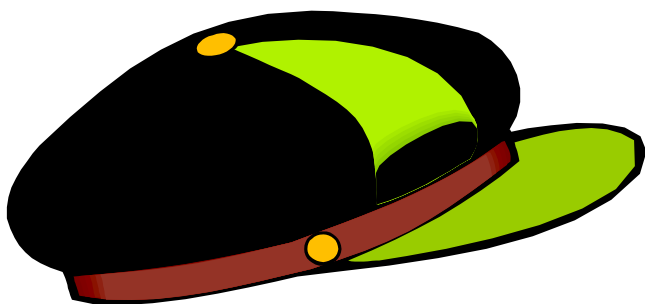
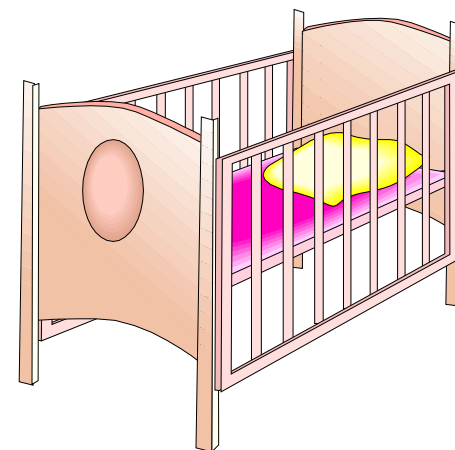
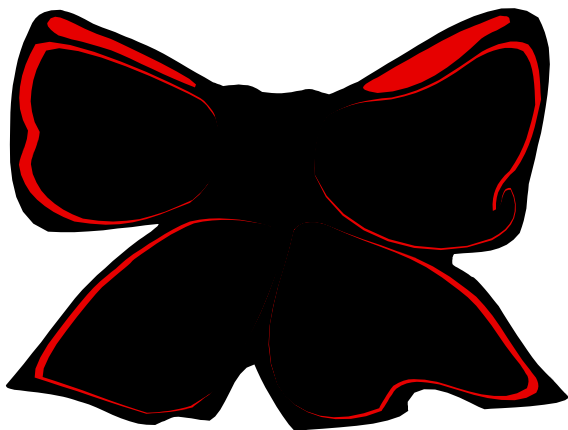

## ASSOCIAZIONI LOGICHE

Far denominare e associare le immagini secondo un legame logico.

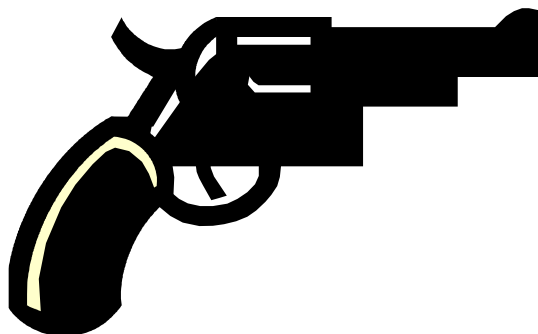
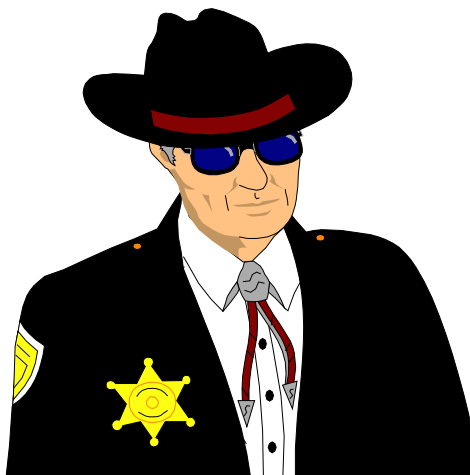
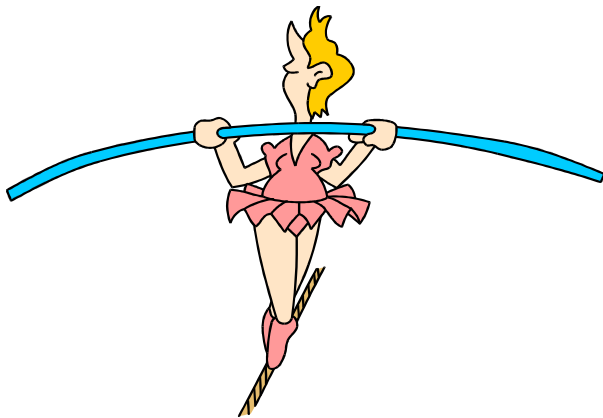

## ASSOCIAZIONI LOGICHE

Far denominare e associare le immagini secondo un legame logico.

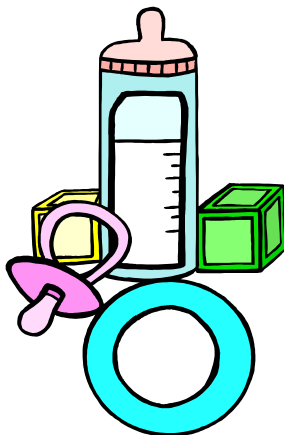
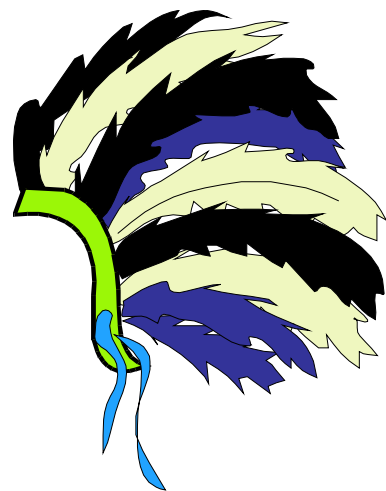
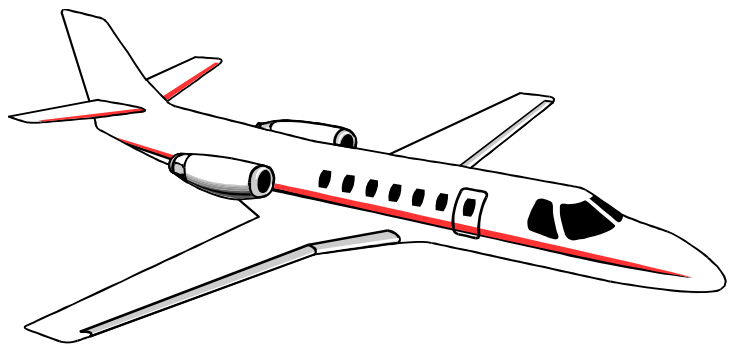

## ASSOCIAZIONI LOGICHE

Far denominare e associare le immagini secondo un legame logico.

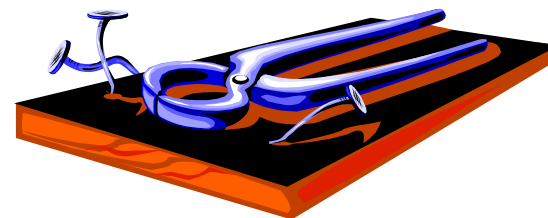
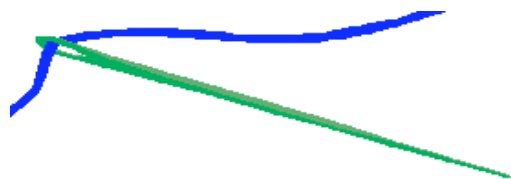
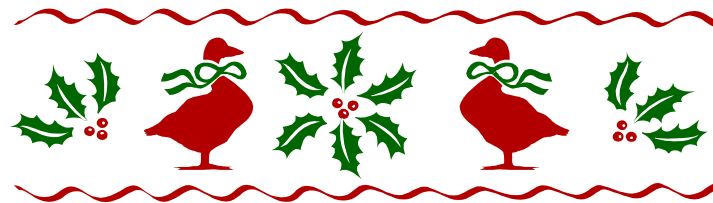

## ASSOCIAZIONI LOGICHE

Far denominare e associare le immagini secondo un legame logico.



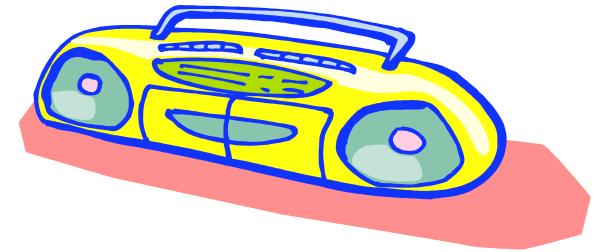
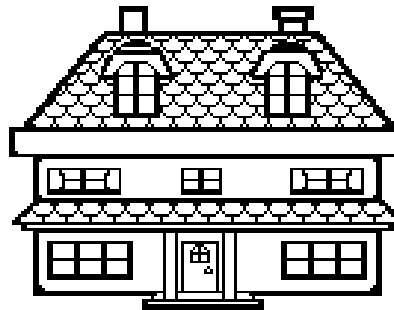
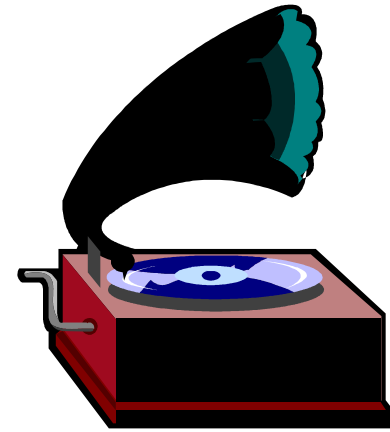
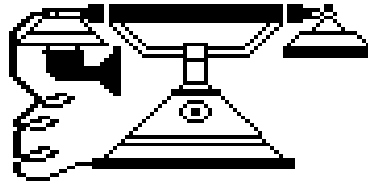

## ASSOCIAZIONI LOGICHE

Far denominare e associare le immagini secondo un legame logico.

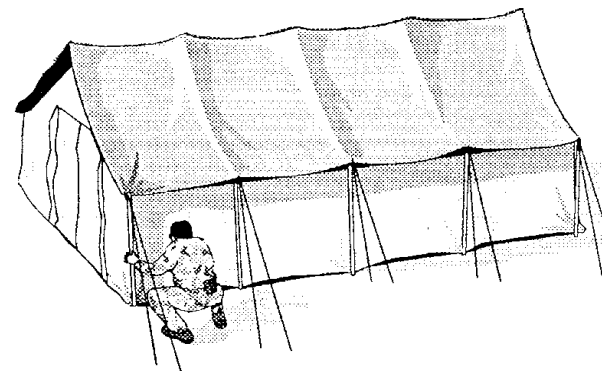
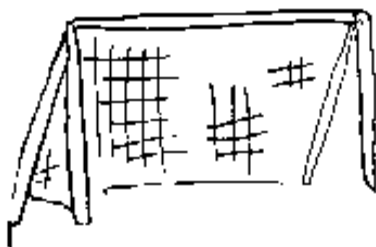
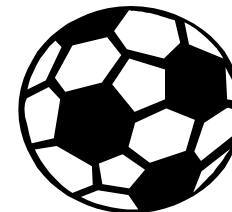
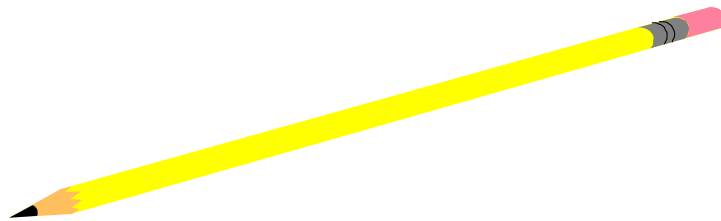

## ASSOCIAZIONI LOGICHE

Far denominare e associare le immagini secondo un legame logico.

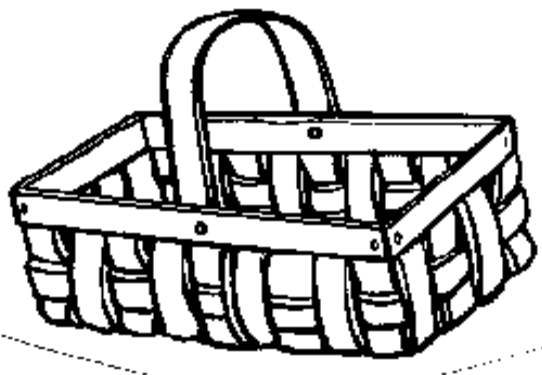
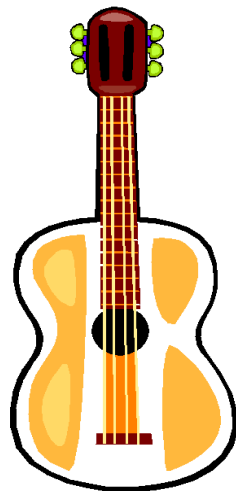
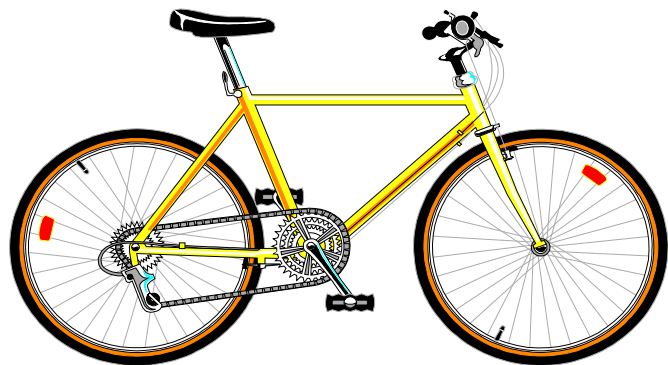

## ASSOCIAZIONI LOGICHE

Far denominare e associare le immagini secondo un legame logico.

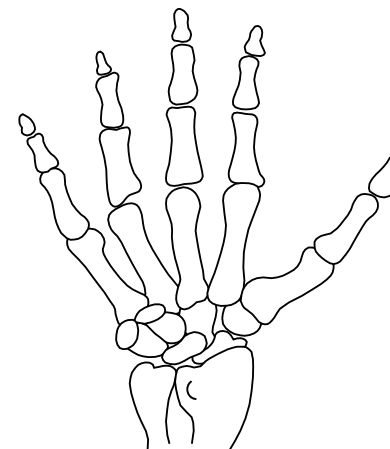
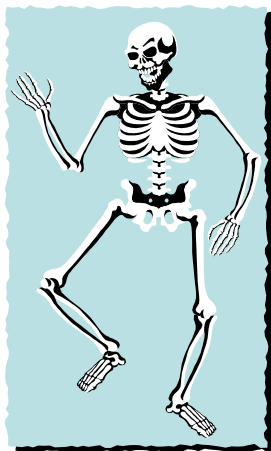
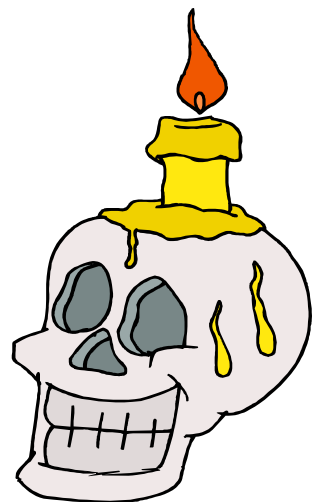
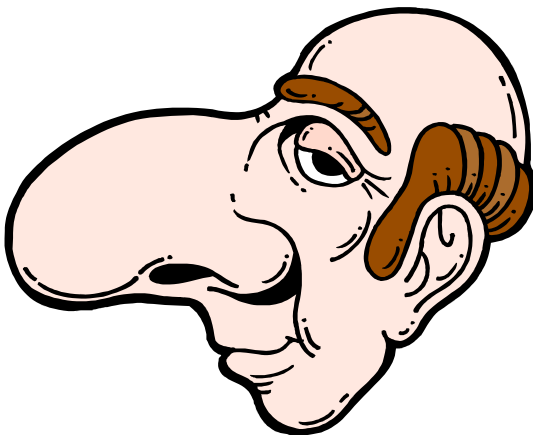
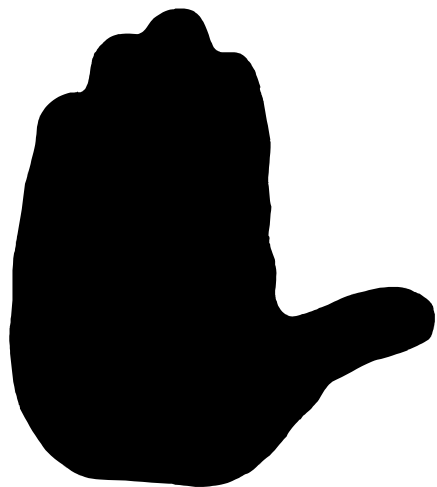

## ASSOCIAZIONI LOGICHE

Far denominare e associare le immagini secondo un legame logico.

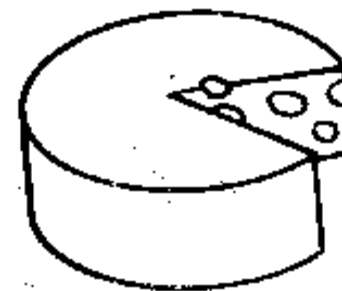
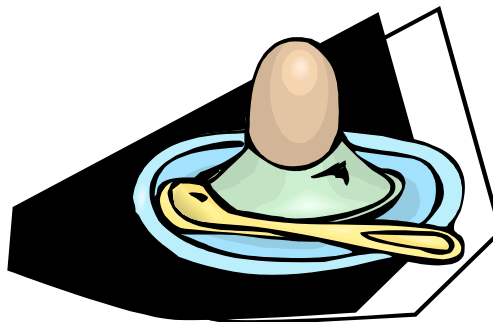
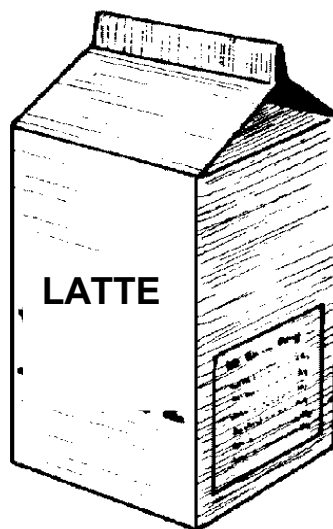

### ASSOCIAZIONI LOGICHE

Far denominare e associare le immagini secondo un legame logico.

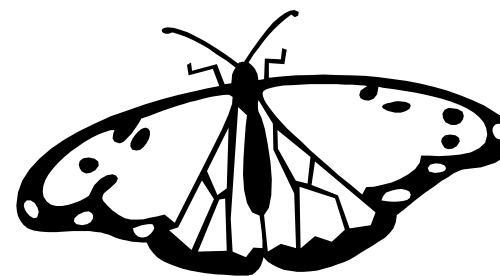
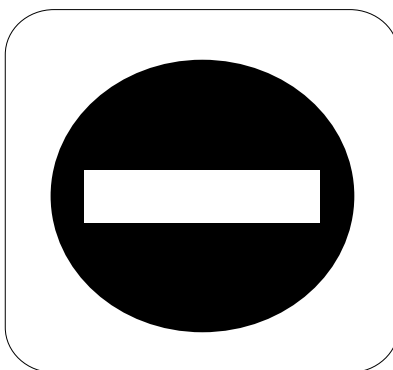
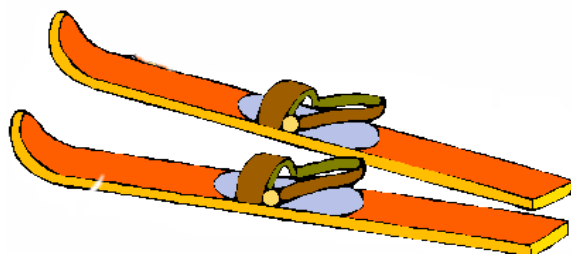
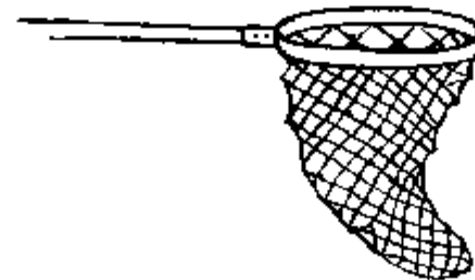
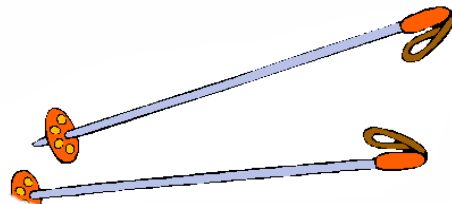

## ASSOCIAZIONI LOGICHE

Far denominare e associare le immagini secondo un legame logico.

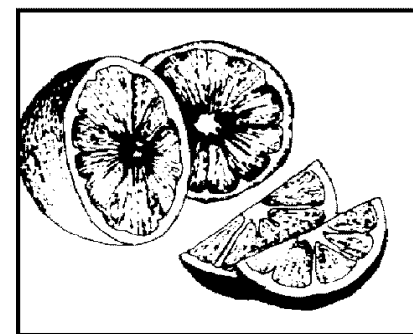
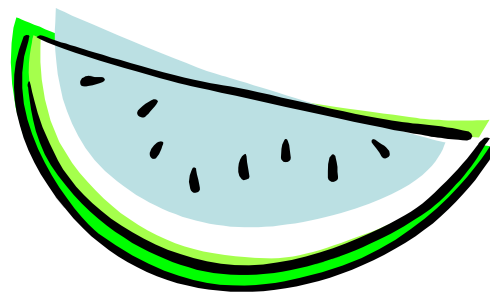
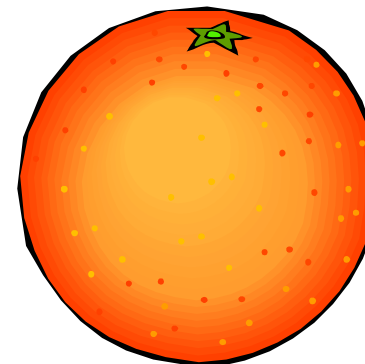
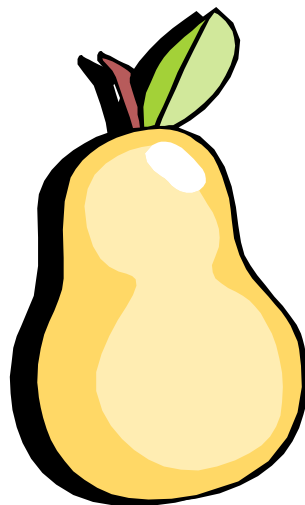
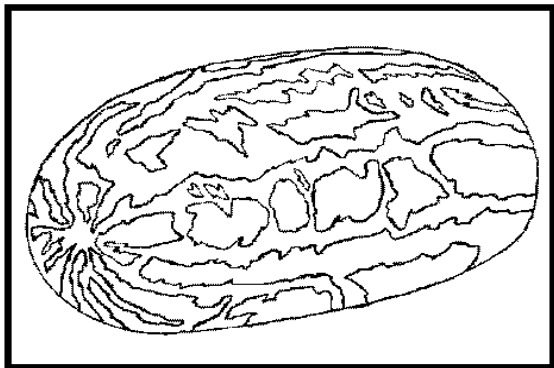

## ASSOCIAZIONI LOGICHE

Far denominare e associare le immagini secondo un legame logico.

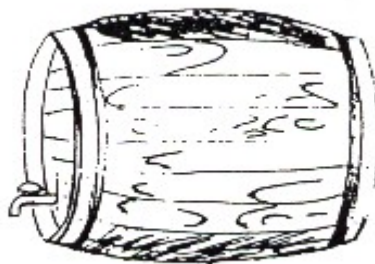

## ASSOCIAZIONI LOGICHE

Far denominare e associare le immagini secondo un legame logico.



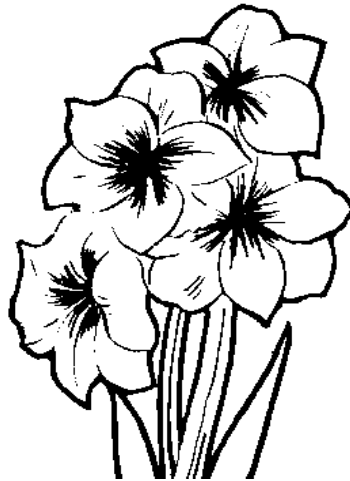
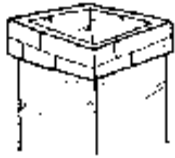

## ASSOCIAZIONI LOGICHE

Far denominare e associare le immagini secondo un legame logico.

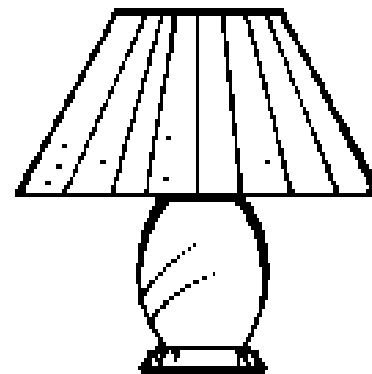
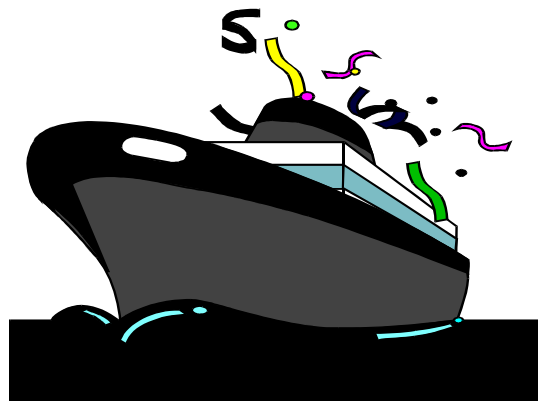
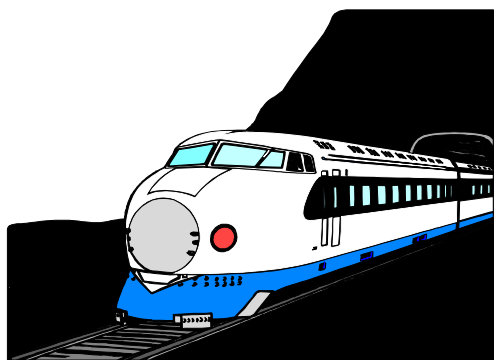
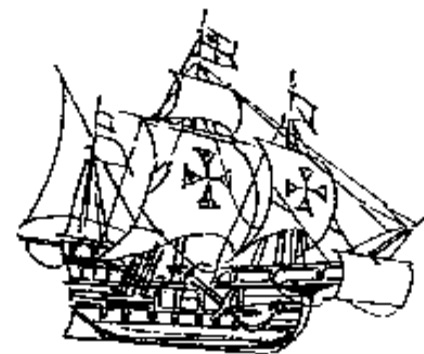
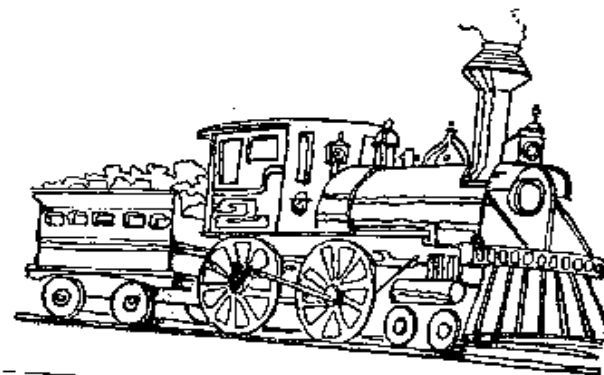
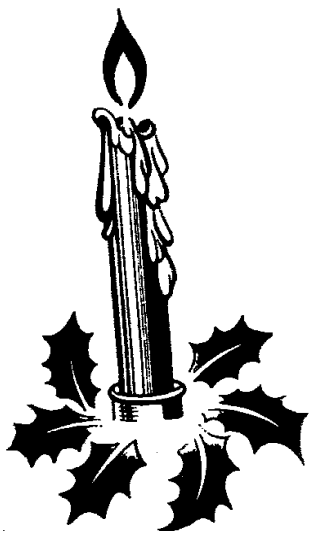

## ASSOCIAZIONI LOGICHE

Far denominare e associare le immagini secondo un legame logico.

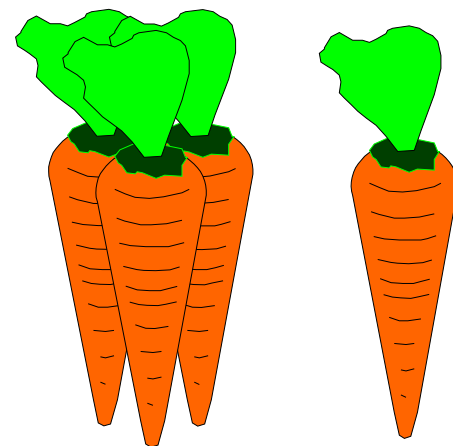
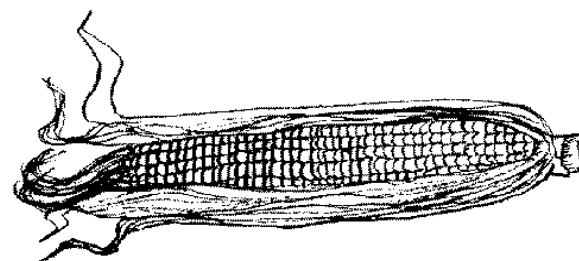

## ASSOCIAZIONI LOGICHE

Far denominare e associare le immagini secondo un legame logico.

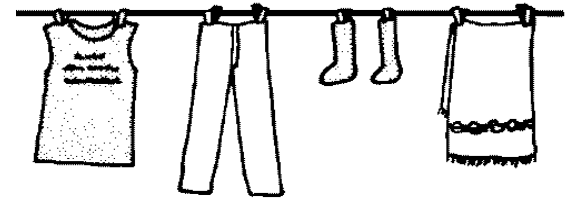
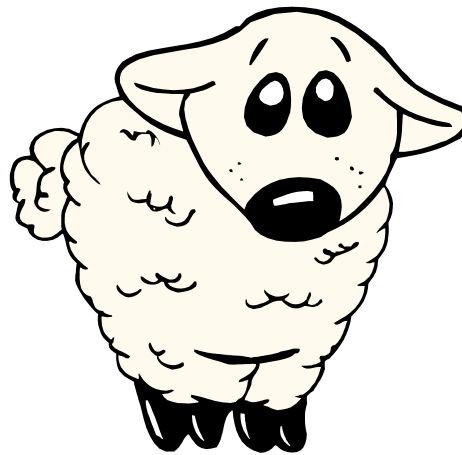
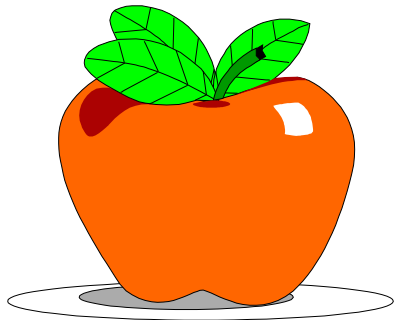

## ASSOCIAZIONI LOGICHE

Far denominare e associare le immagini secondo un legame logico.

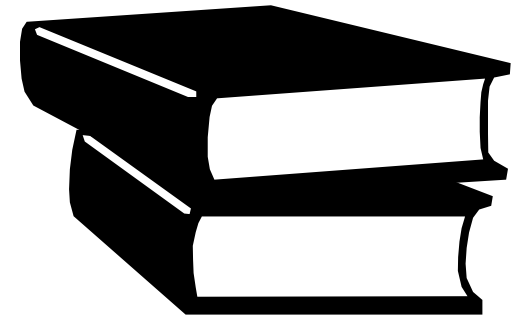
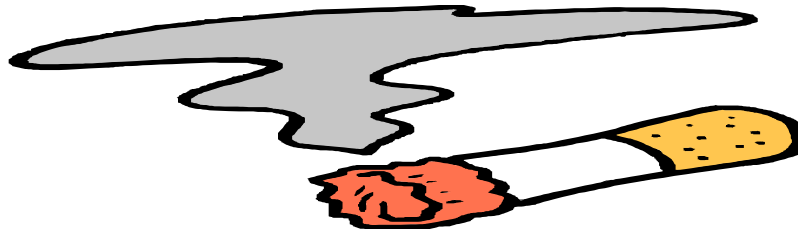
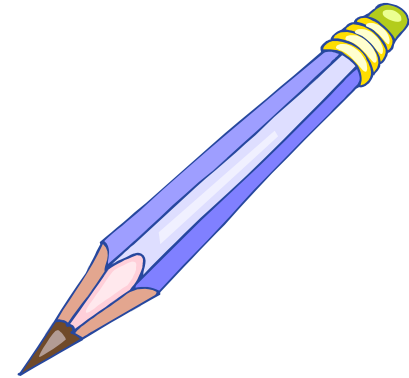

## ASSOCIAZIONI LOGICHE

Far denominare e associare le immagini secondo un legame logico.

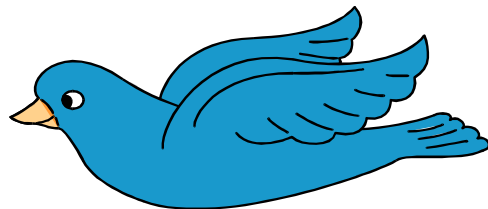
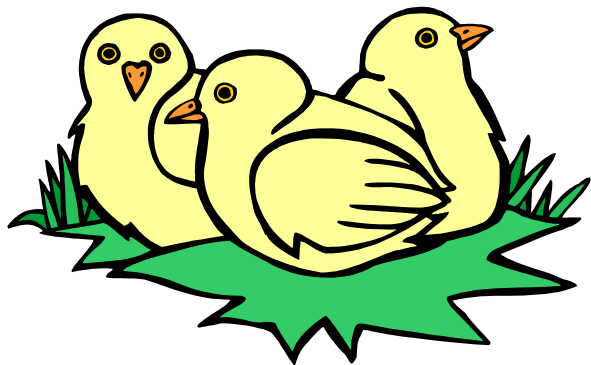

## ASSOCIAZIONI LOGICHE

Far denominare e associare le immagini secondo un legame logico.

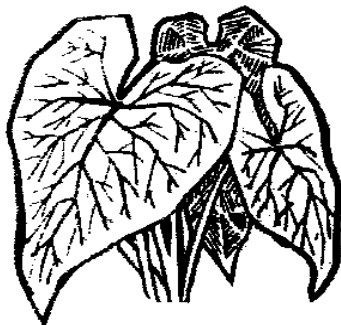
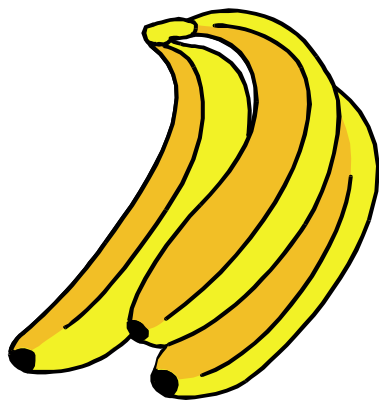
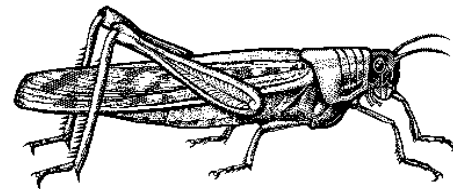
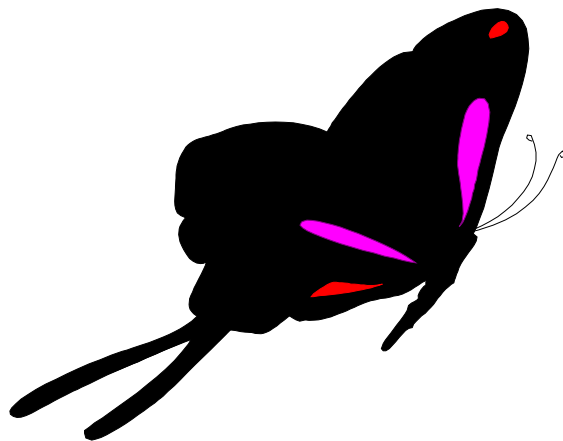
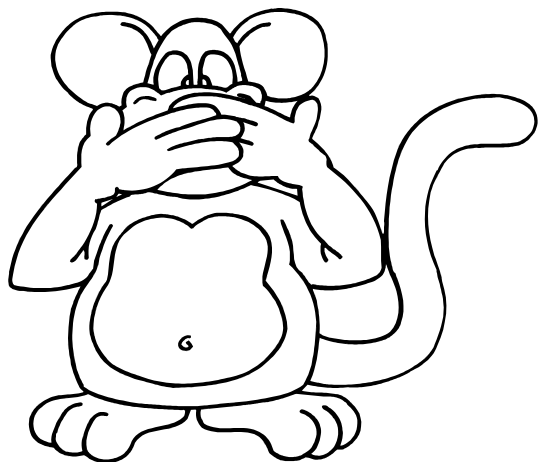

### ASSOCIAZIONI LOGICHE

Far denominare e associare le immagini secondo un legame logico.

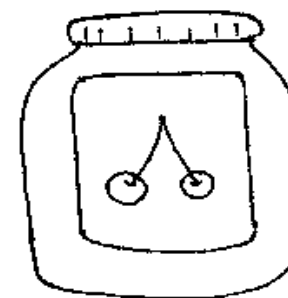
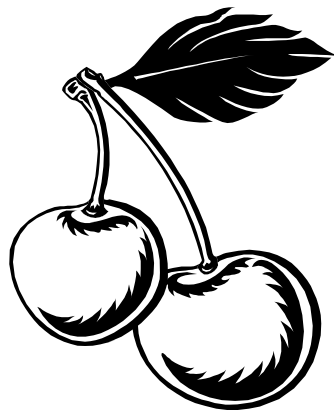

## ASSOCIAZIONI LOGICHE

Far denominare e associare le immagini secondo un legame logico.



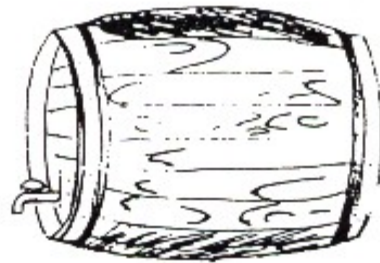
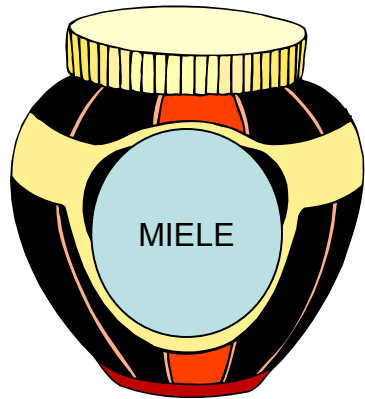
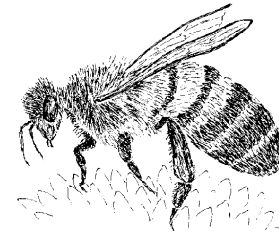

### ASSOCIAZIONI LOGICHE

Far denominare e associare le immagini secondo un legame logico.

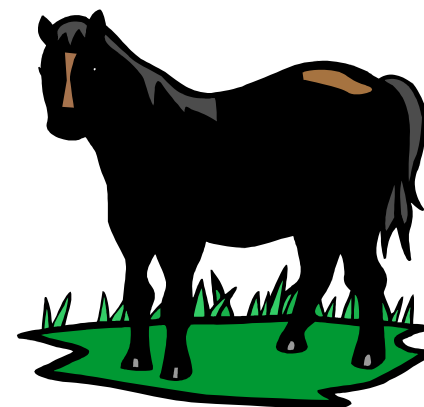
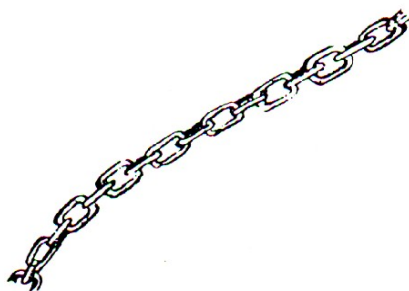
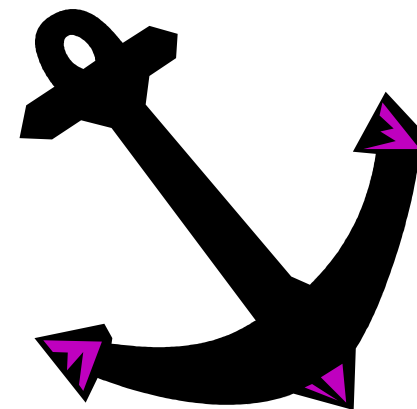

## ASSOCIAZIONI LOGICHE

Far denominare e associare le immagini secondo un legame logico.

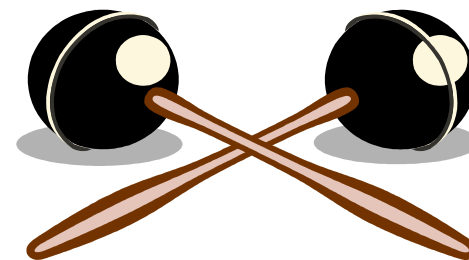
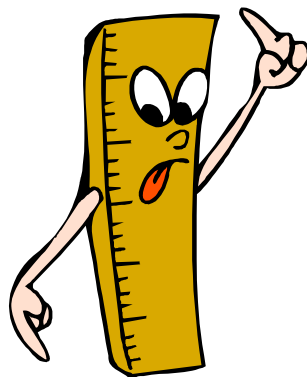
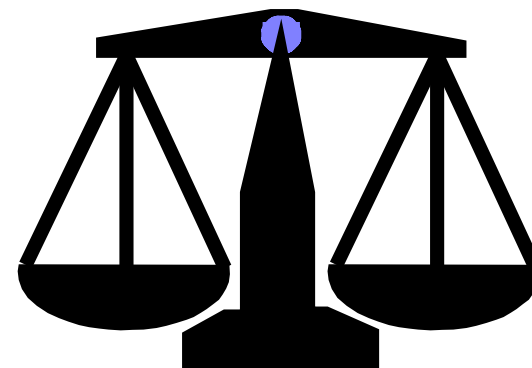
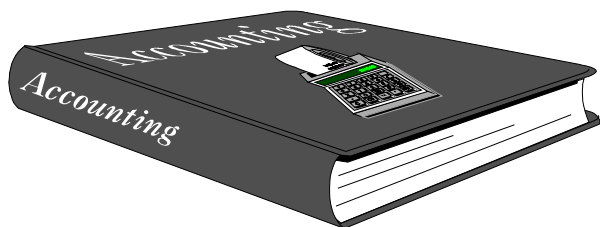

## ASSOCIAZIONI LOGICHE

Far denominare e associare le immagini secondo un legame logico.

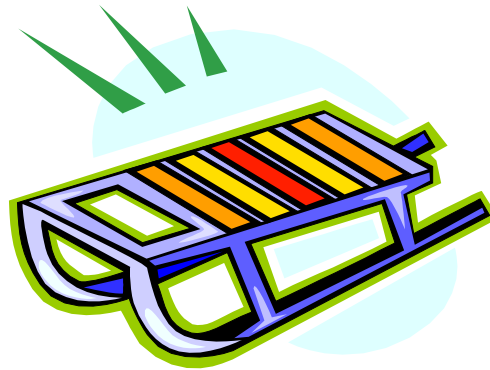
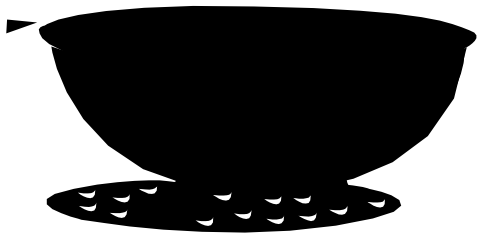
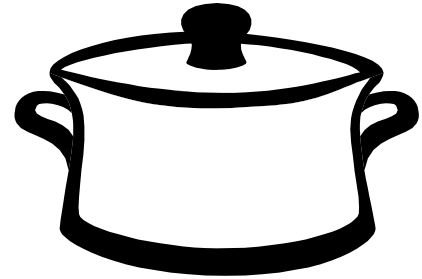
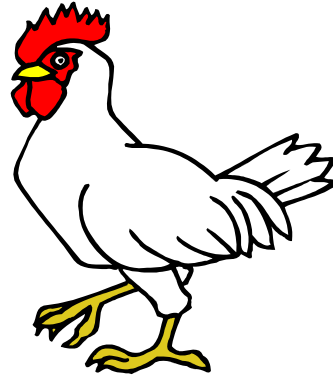
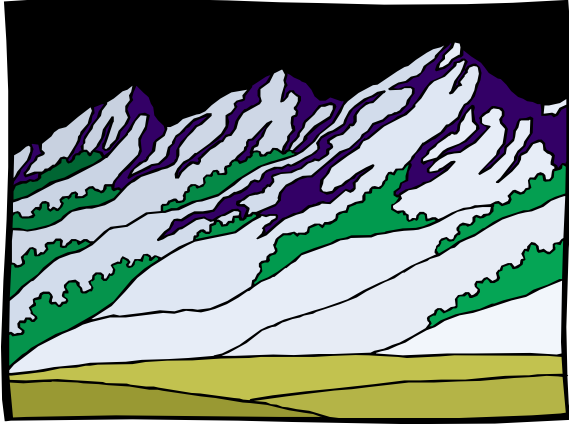

## ASSOCIAZIONI LOGICHE

Far denominare e associare le immagini secondo un legame logico.

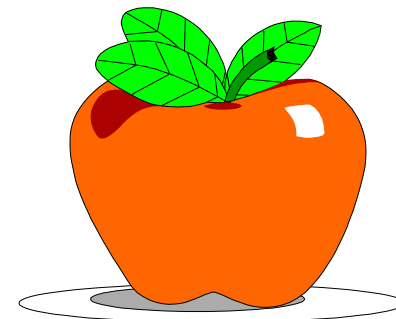
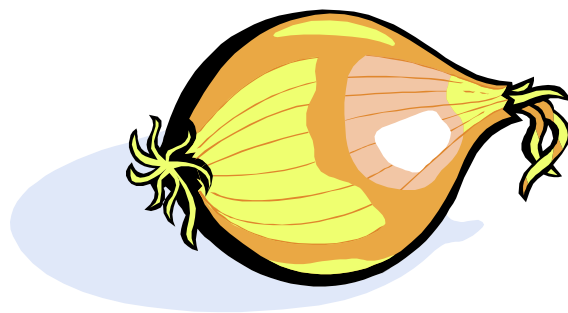
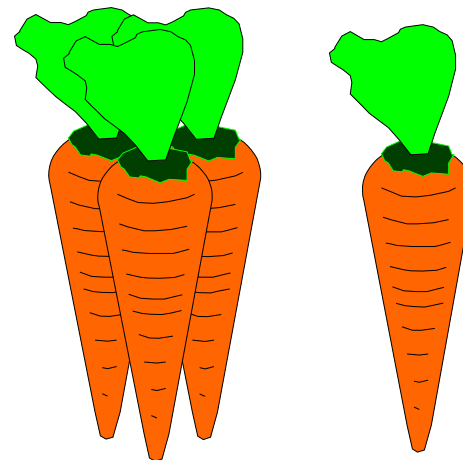

## ASSOCIAZIONI LOGICHE

Far denominare e associare le immagini secondo un legame logico.

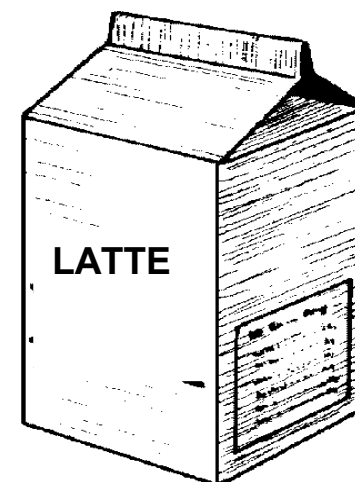
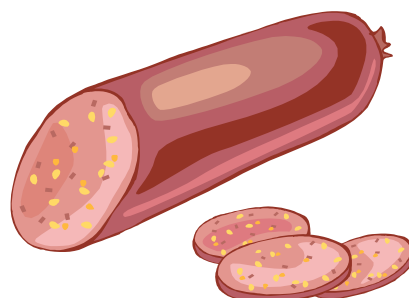
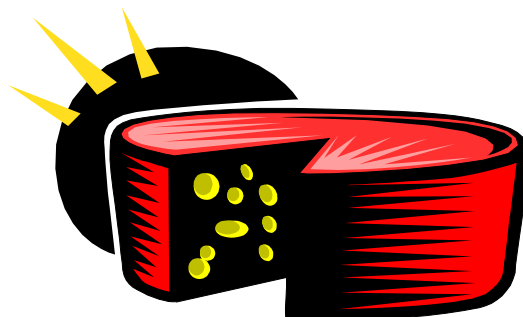
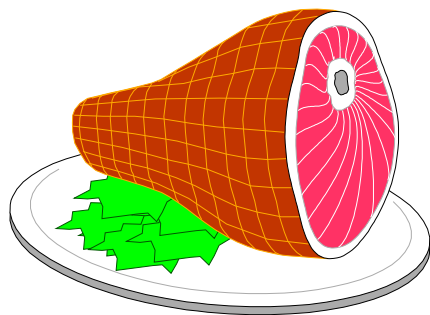

## ASSOCIAZIONI LOGICHE

Far denominare e associare le immagini secondo un legame logico.

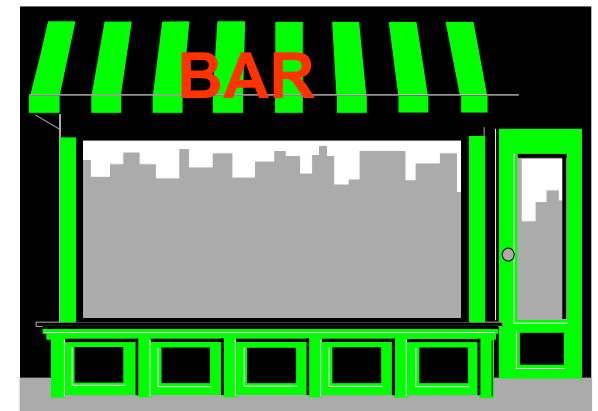
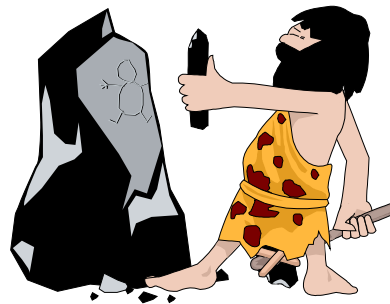
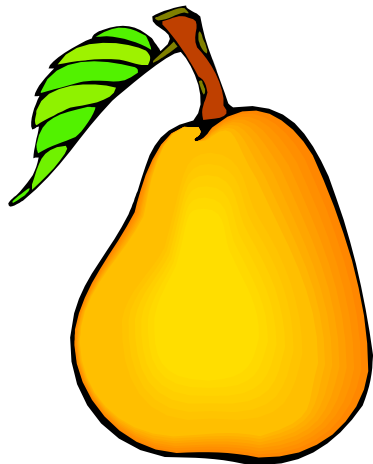
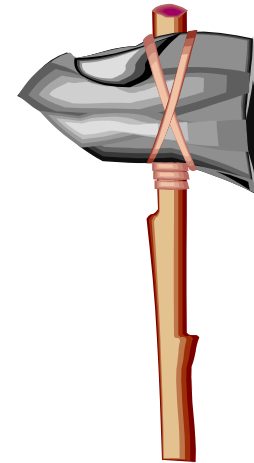
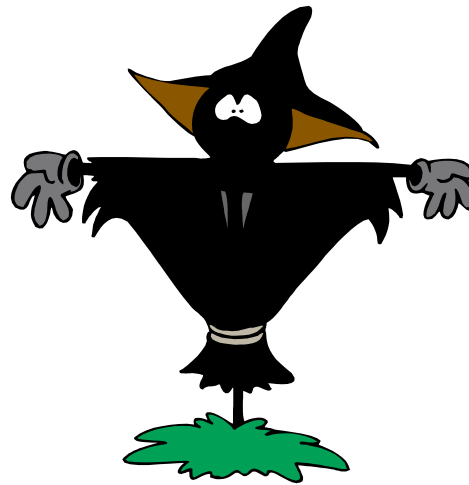

## ASSOCIAZIONI LOGICHE

Far denominare e associare le immagini secondo un legame logico.

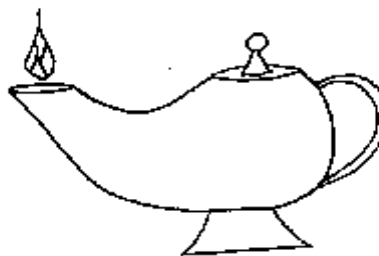
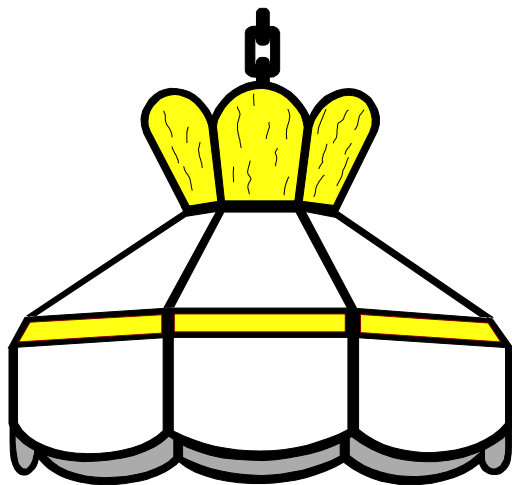
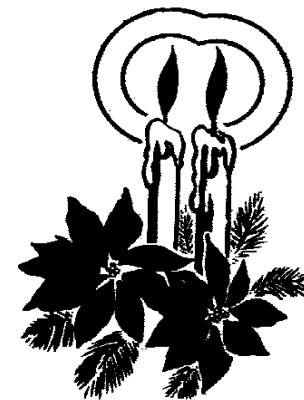
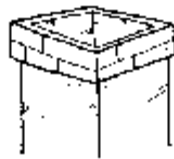
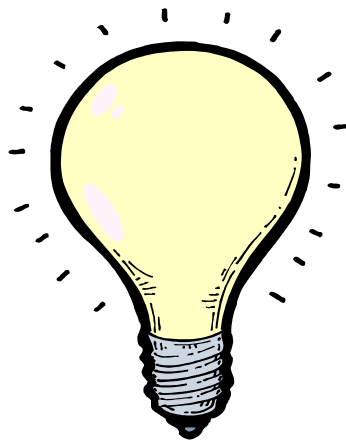

## ASSOCIAZIONI LOGICHE

Far denominare e associare le immagini secondo un legame logico.



## **ASSOCIAZIONI DI IMMAGINI UGUALI**

La possibilità di stimolazione logica fino ai tre anni coincide per lo più con lo sviluppo psicomotorio, percettivo e del linguaggio.

Il bambino, infatti, manifesta le sue capacità logiche attraverso un'attività rivolta soprattutto all'analisi, confronto e interpretazione della realtà sensoriale.

Nella sua esplorazione del mondo vengono ad essere coinvolti tutti i sensi per cui è importante una molteplicità di stimolazioni. Maggiore attenzione noi diamo alla percezione uditiva e visiva, in quanto è più facile, per gli studiosi e per gli educatori in genere, preparare e somministrare materiale graduato e opportunamente variato composto da immagini, da suoni e parole, piuttosto che da gusti, da odori o da elementi tattili.

Le schede che qui presentiamo sono formate da immagini uguali o simili, a volte parzialmente cancellate, da riconoscere e da associare che hanno lo scopo di sviluppare nel bambino non solo la percezione visiva ma anche il linguaggio, ed i primi processi di astrazione. Sono numerose, inoltre, le associazioni che hanno una simile collocazione nello spazio.

Il bambino viene inoltre arricchito da numerosi elementi culturali.

### **UTILIZZAZIONE**

L'educatore dicendo il nome dell'immagine presente nella parte alta della scheda chiederà al bambino di toccare con le dita la stessa immagine presente nella parte bassa.

Nel caso di bambini molto piccoli o inibiti l'educatore potrà tenere con la sua la mano del bambino in modo tale da incoraggiarlo e avviarlo al gioco associativo.

### **ETA' MENTALE DI RIFERIMENTO**

Cinque anni.



ASSOCIAZIONI DI IMMAGINI UGUALI O SIMILI

Far associare le immagini uguali o simili.



ASSOCIAZIONI DI IMMAGINI UGUALI O SIMILI

Far associare le immagini uguali o simili.

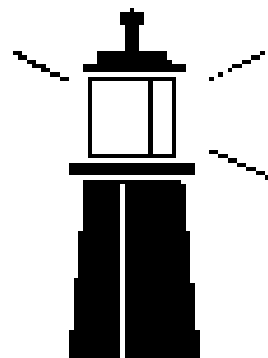
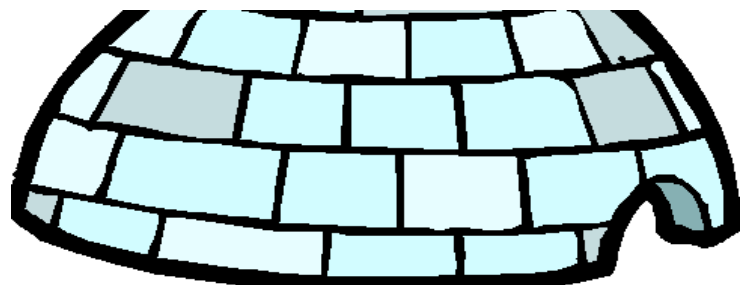
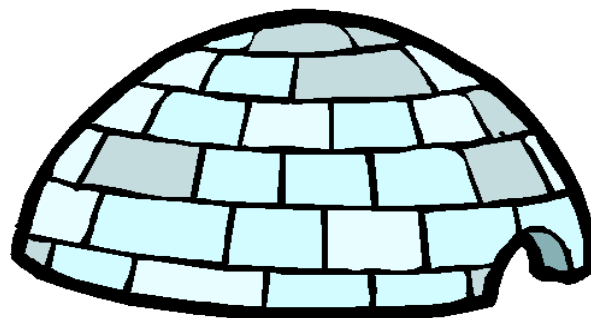
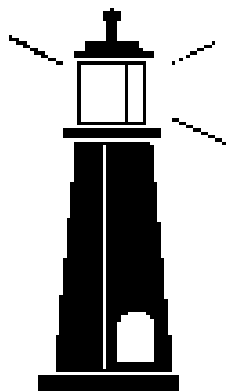

ASSOCIAZIONI DI IMMAGINI UGUALI O SIMILI

Far associare le immagini uguali o simili.

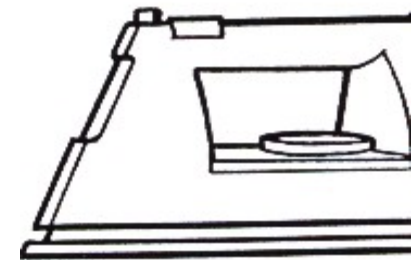
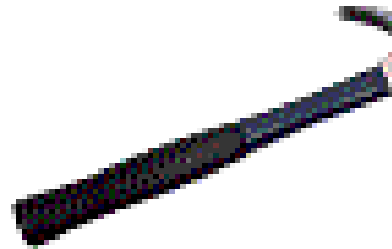
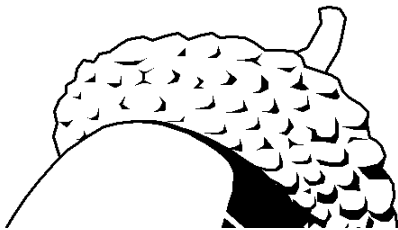
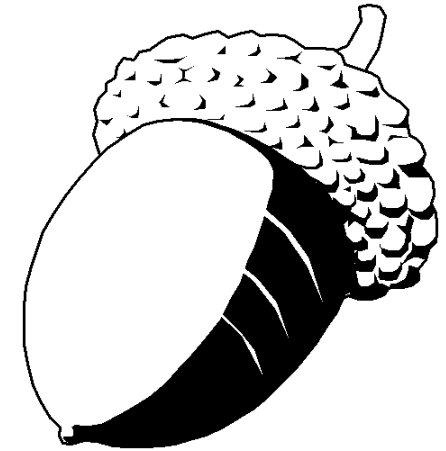
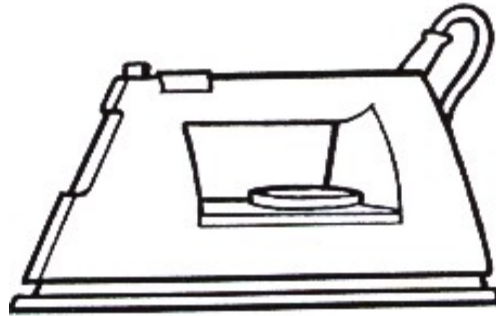

ASSOCIAZIONI DI IMMAGINI UGUALI O SIMILI

Far associare le immagini uguali o simili.

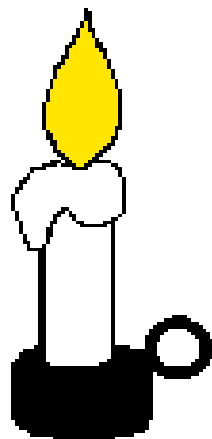
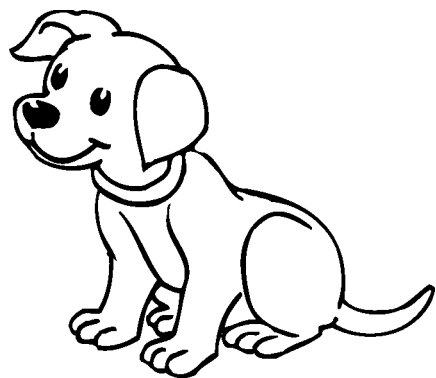

ASSOCIAZIONI DI IMMAGINI UGUALI O SIMILI

Far associare le immagini uguali o simili.

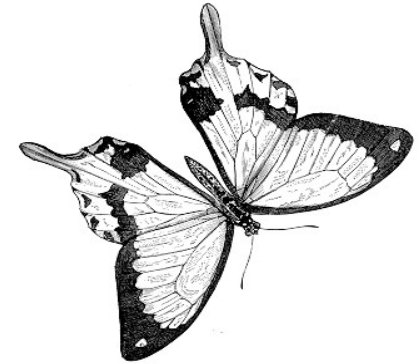
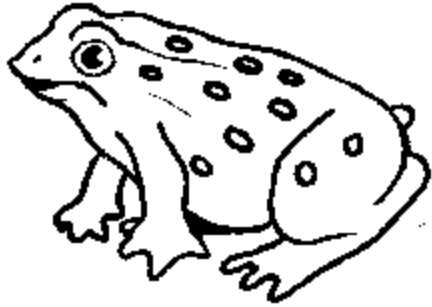

ASSOCIAZIONI DI IMMAGINI UGUALI O SIMILI

Far associare le immagini uguali o simili.

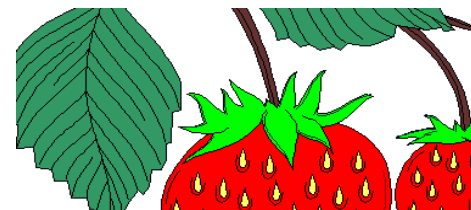
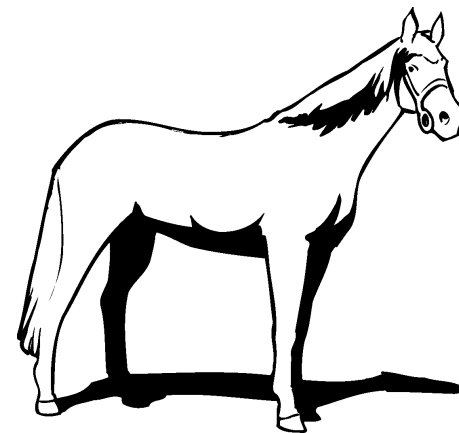
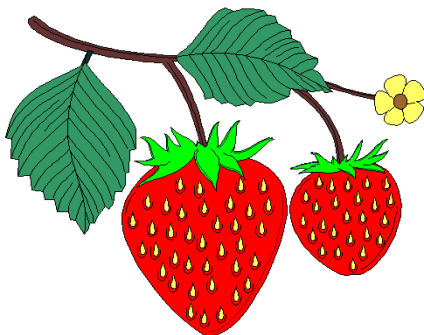

ASSOCIAZIONI DI IMMAGINI UGUALI O SIMILI

Far associare le immagini uguali o simili.



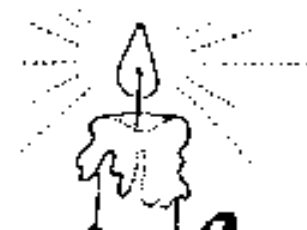
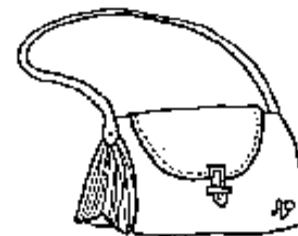
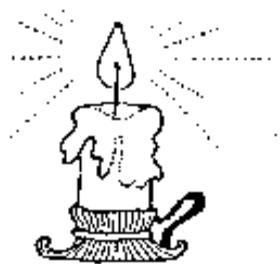

ASSOCIAZIONI DI IMMAGINI UGUALI O SIMILI

Far associare le immagini uguali o simili.

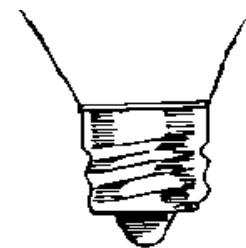
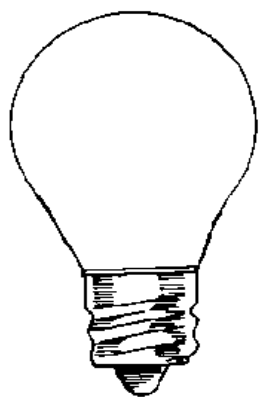

ASSOCIAZIONI DI IMMAGINI UGUALI O SIMILI

Far associare le immagini uguali o simili.

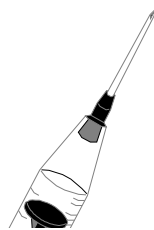
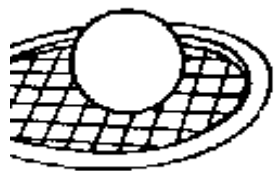
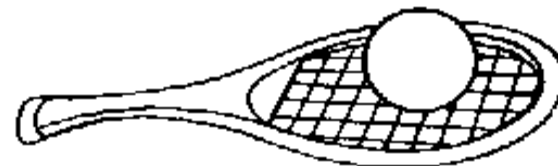
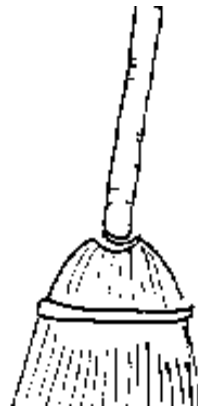
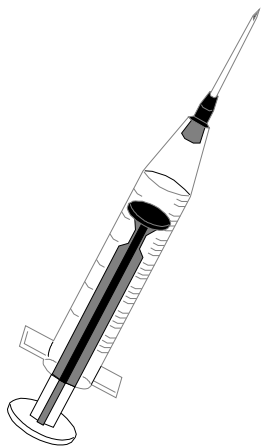

ASSOCIAZIONI DI IMMAGINI UGUALI O SIMILI

Far associare le immagini uguali o simili.

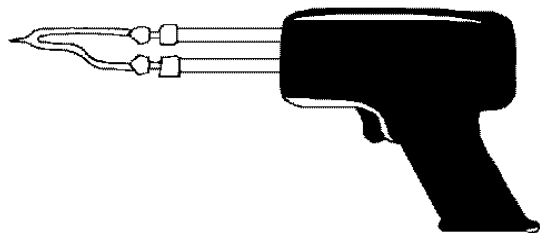

ASSOCIAZIONI DI IMMAGINI UGUALI O SIMILI

Far associare le immagini uguali o simili.

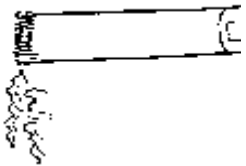
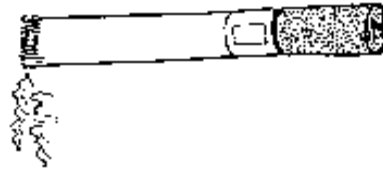

ASSOCIAZIONI DI IMMAGINI UGUALI O SIMILI

Far associare le immagini uguali o simili.

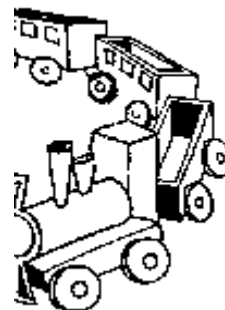
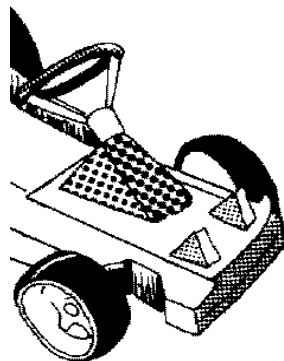
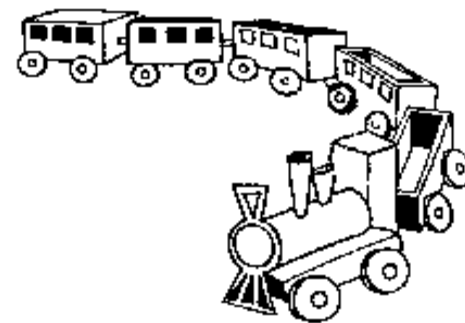
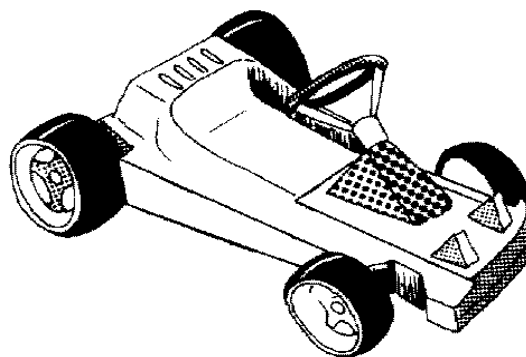
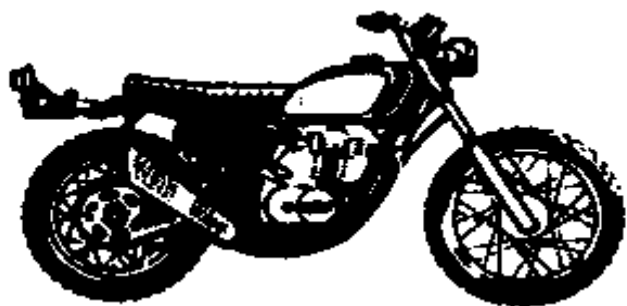

ASSOCIAZIONI DI IMMAGINI UGUALI O SIMILI

Far associare le immagini uguali o simili.

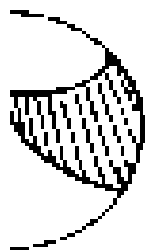
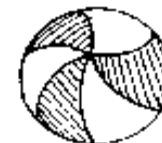

ASSOCIAZIONI DI IMMAGINI UGUALI O SIMILI

Far associare le immagini uguali o simili.

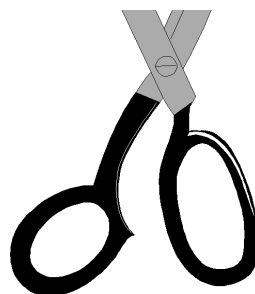
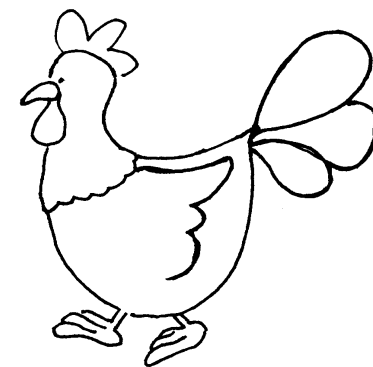
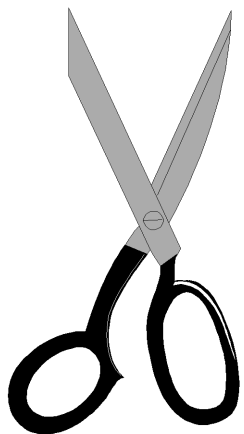

ASSOCIAZIONI DI IMMAGINI UGUALI O SIMILI

Far associare le immagini uguali o simili.



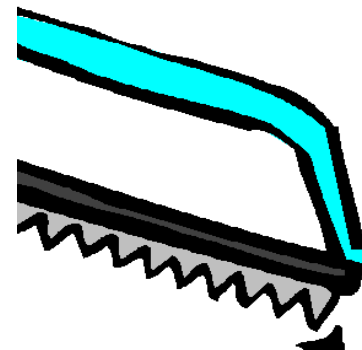
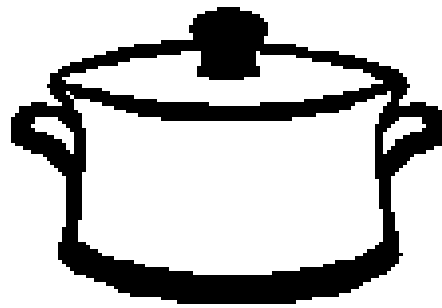
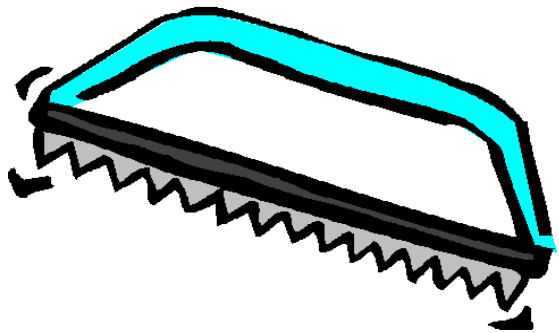

ASSOCIAZIONI DI IMMAGINI UGUALI O SIMILI

Far associare le immagini uguali o simili.

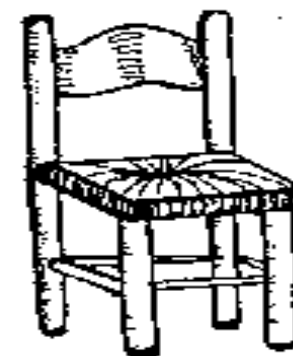
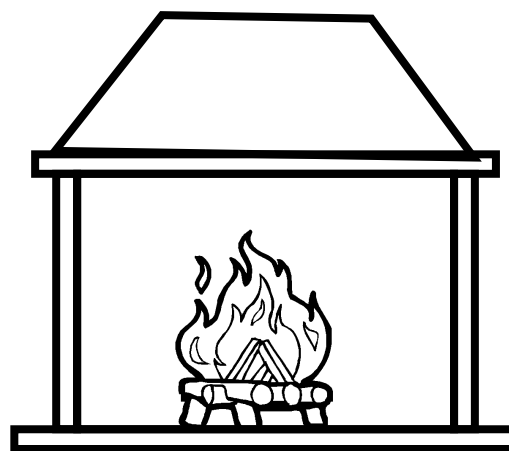
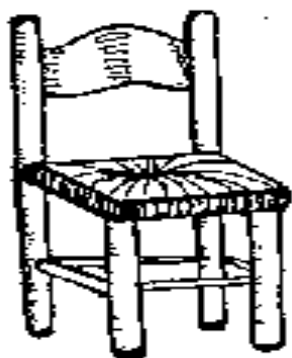

ASSOCIAZIONI DI IMMAGINI UGUALI O SIMILI

Far associare le immagini uguali o simili.

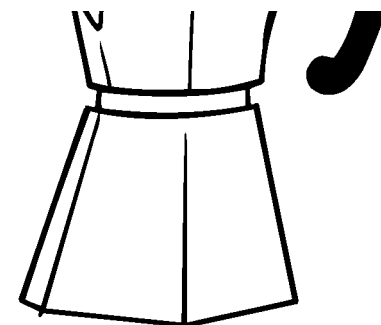
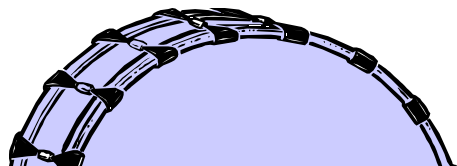
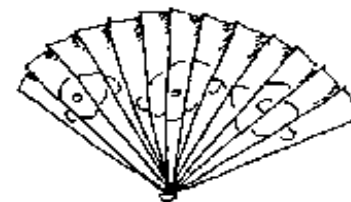
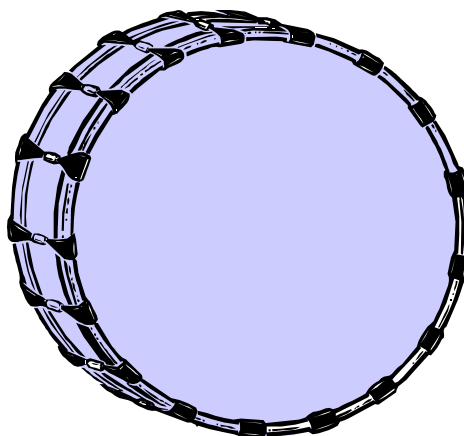

ASSOCIAZIONI DI IMMAGINI UGUALI O SIMILI

Far associare le immagini uguali o simili.

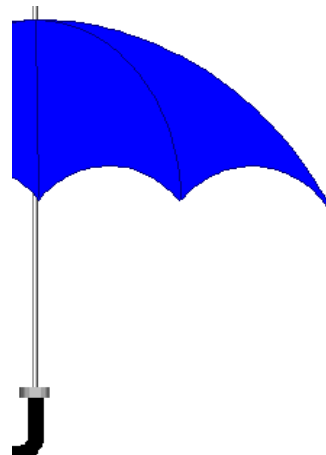
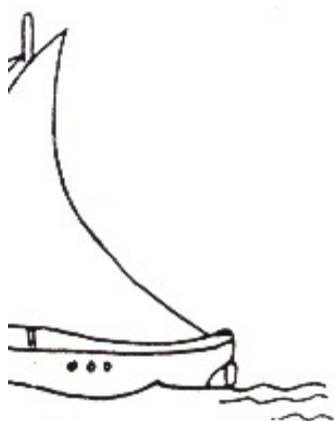
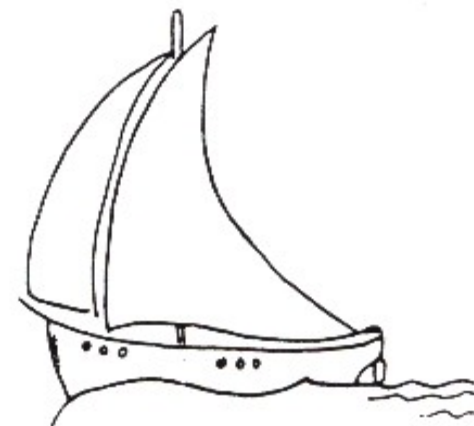
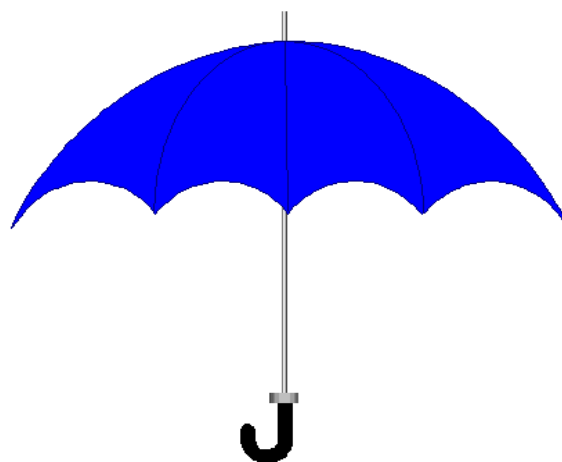

ASSOCIAZIONI DI IMMAGINI UGUALI O SIMILI

Far associare le immagini uguali o simili.

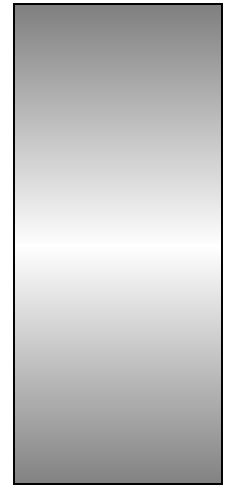
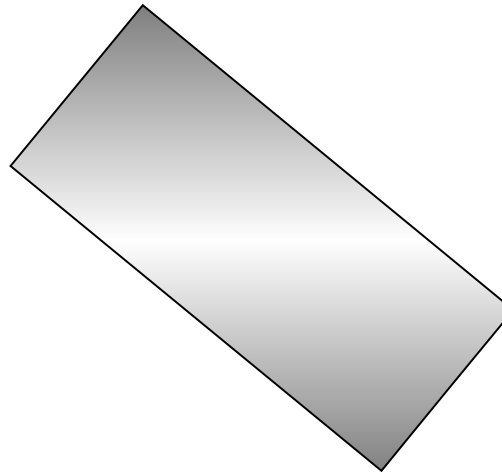
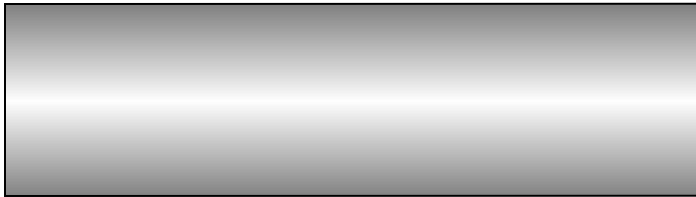
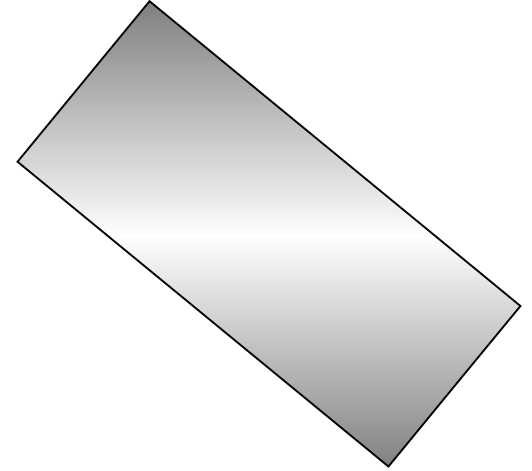
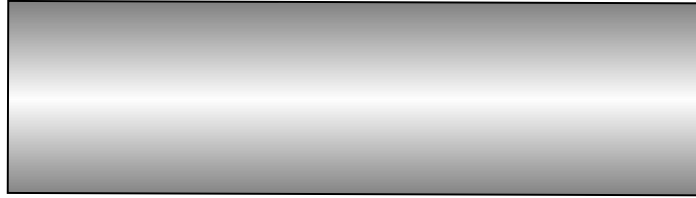
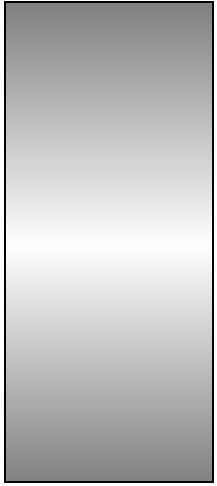

ASSOCIAZIONI DI IMMAGINI UGUALI O SIMILI

Far associare le immagini uguali o simili.

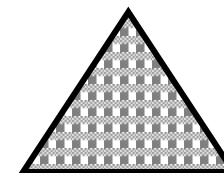
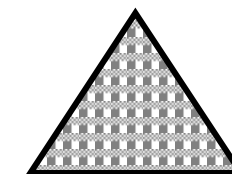
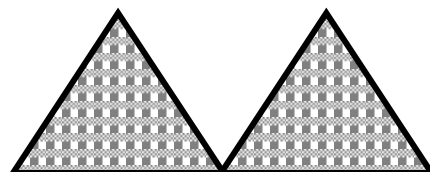
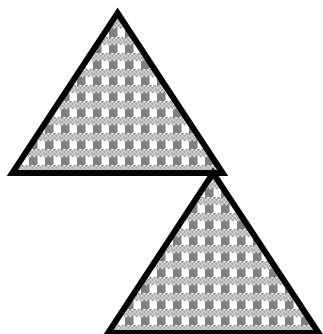
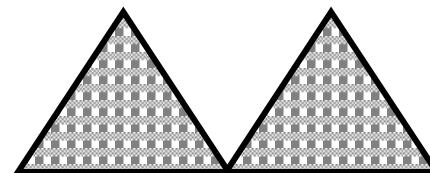
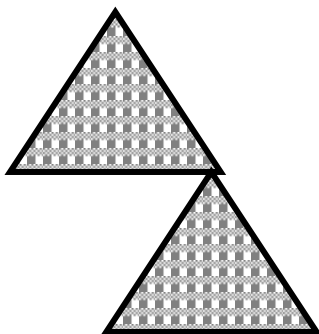
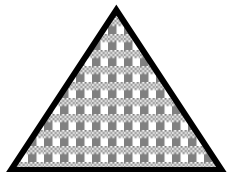
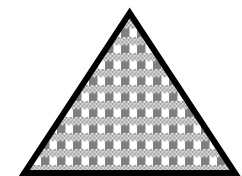

ASSOCIAZIONI DI IMMAGINI UGUALI O SIMILI

Far associare le immagini uguali o simili.

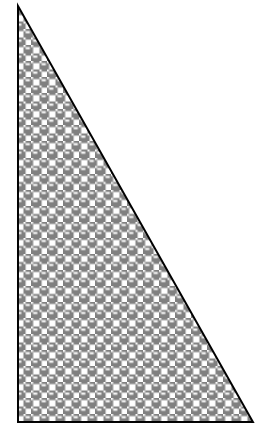
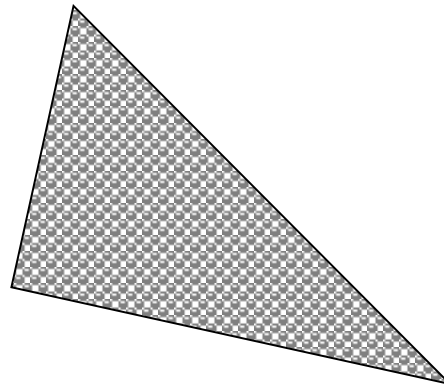
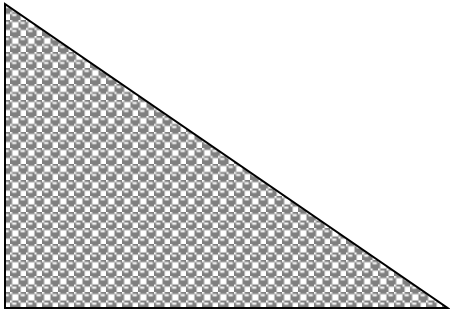
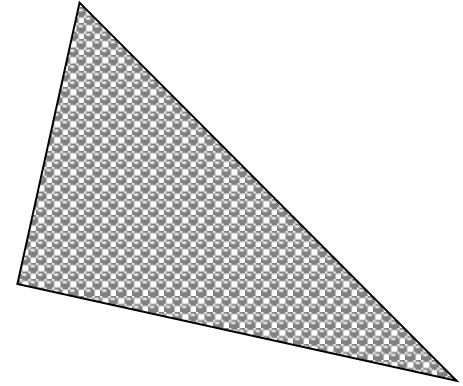
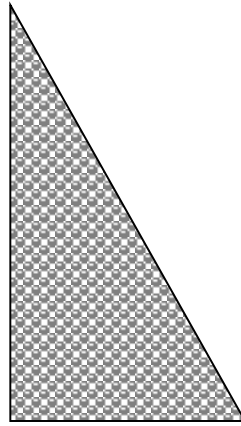
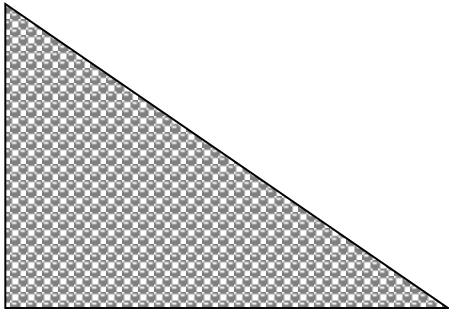

ASSOCIAZIONI DI IMMAGINI UGUALI O SIMILI

Far associare le immagini uguali o simili.

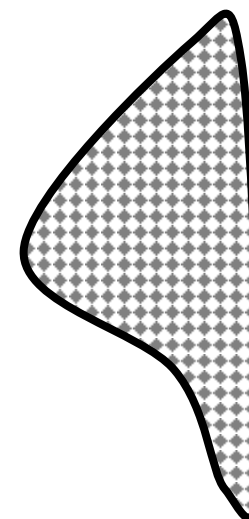
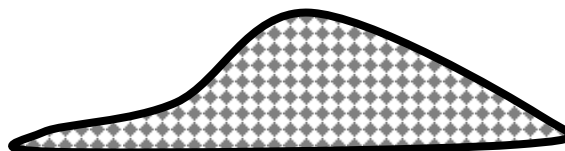
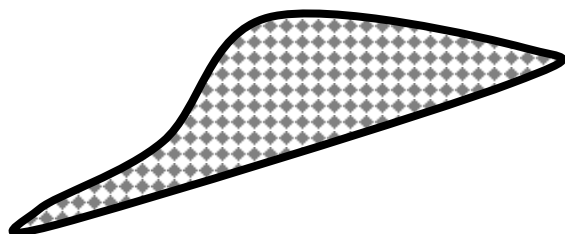
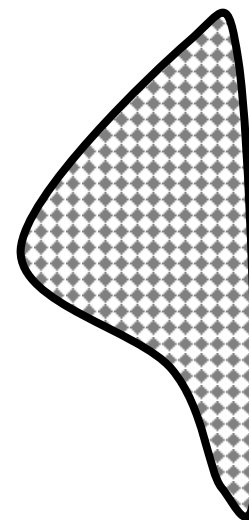
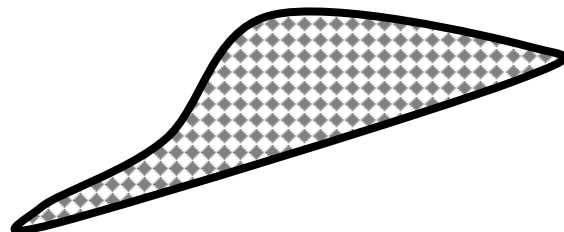
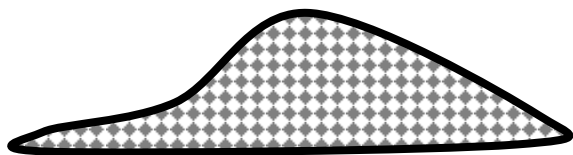

ASSOCIAZIONI DI IMMAGINI UGUALI O SIMILI

Far associare le immagini uguali o simili.



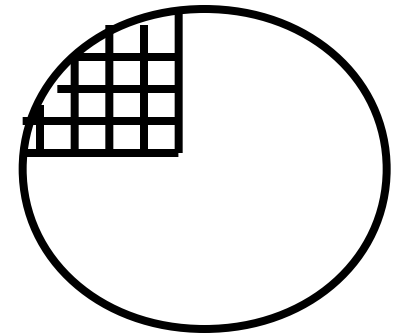
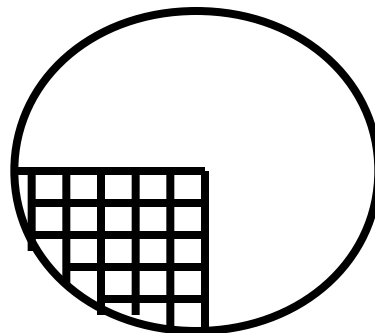
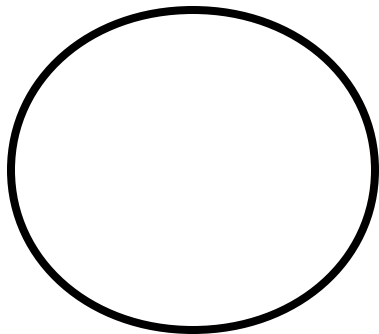
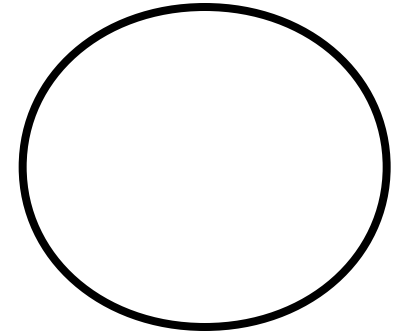
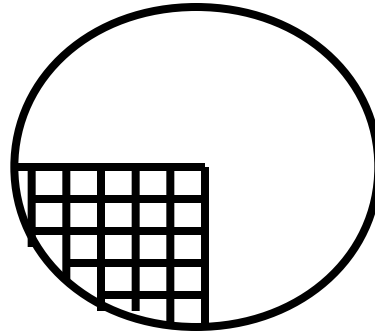
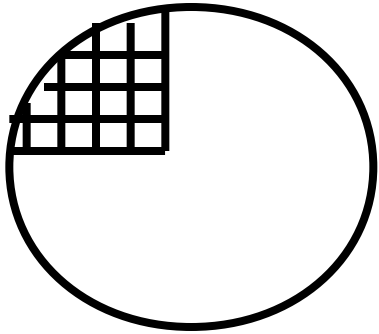

ASSOCIAZIONI DI IMMAGINI UGUALI O SIMILI

Far associare le immagini uguali o simili.

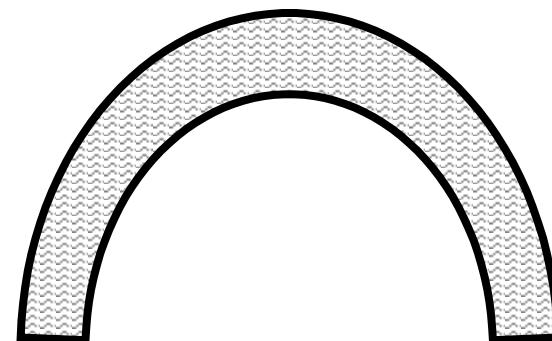
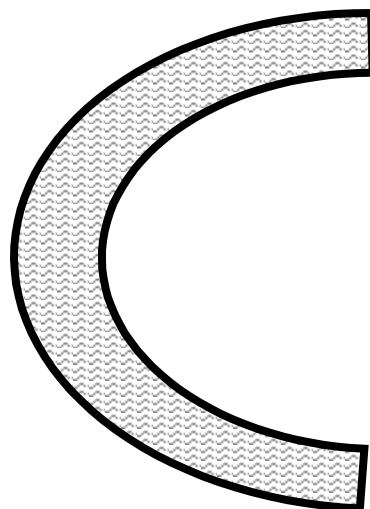
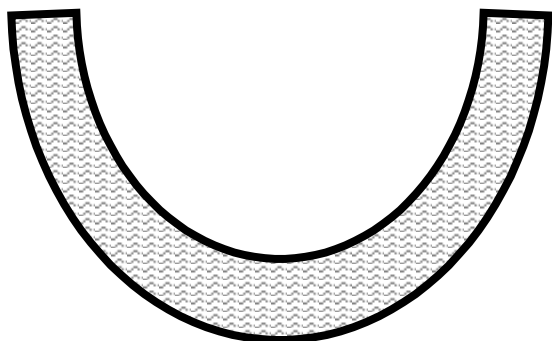
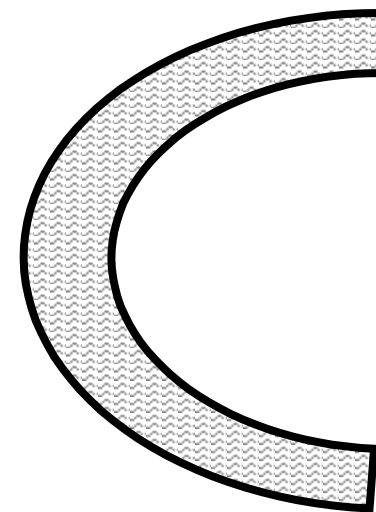
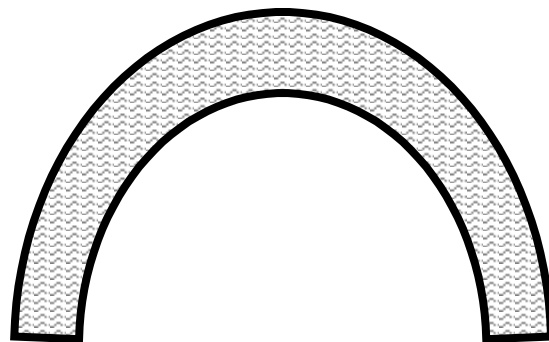
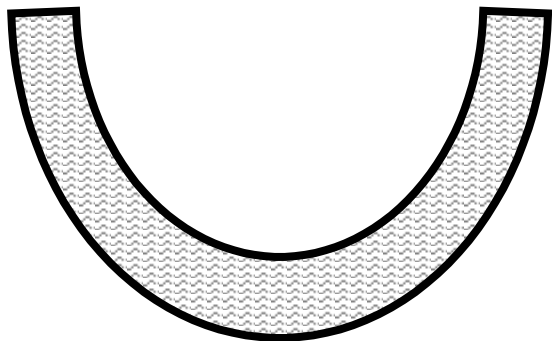

ASSOCIAZIONI DI IMMAGINI UGUALI O SIMILI

Far associare le immagini uguali o simili.

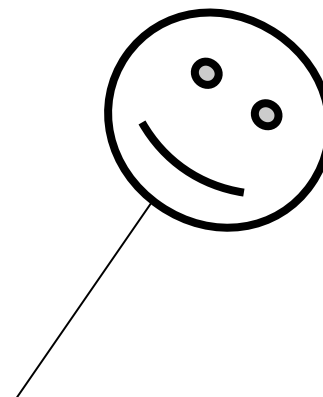
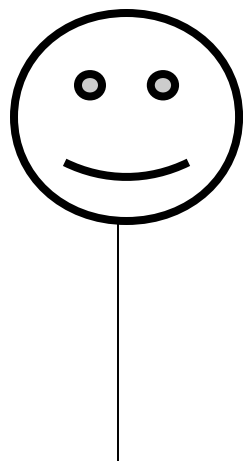
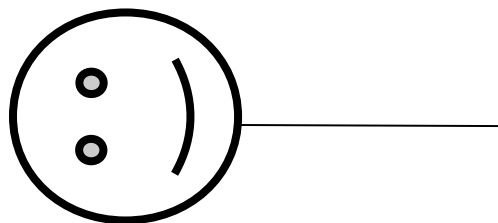
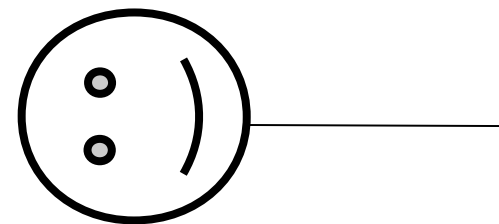
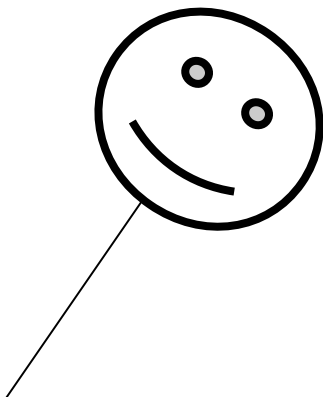
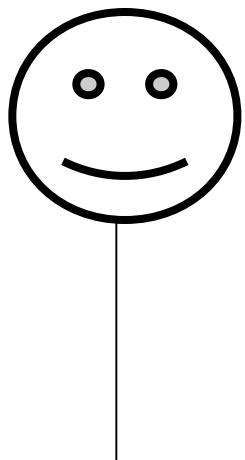

ASSOCIAZIONI DI IMMAGINI UGUALI O SIMILI

Far associare le immagini uguali o simili.

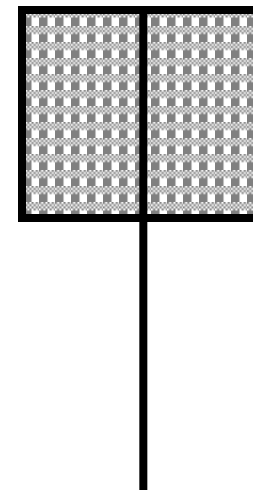
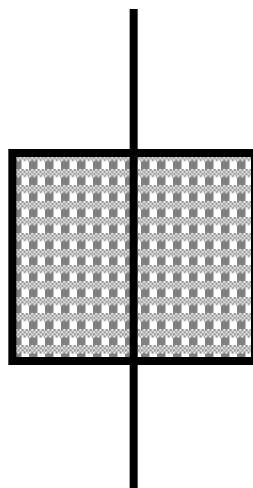
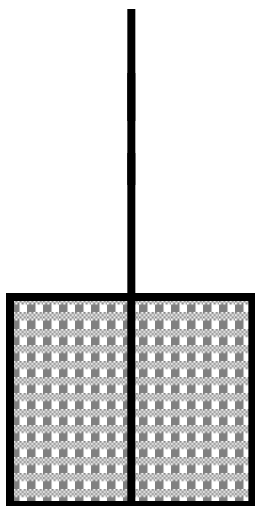
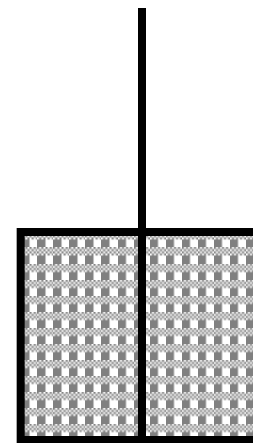
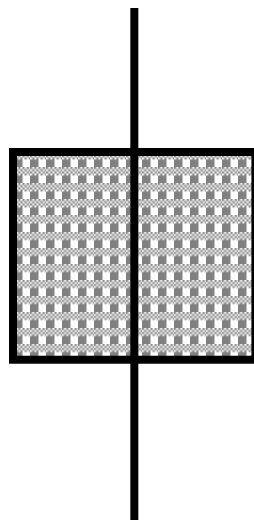
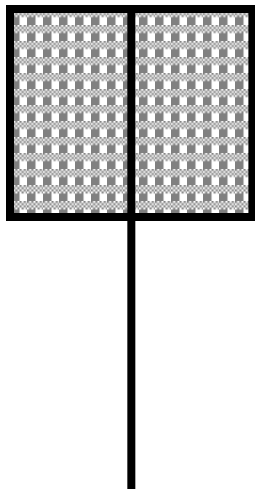

ASSOCIAZIONI DI IMMAGINI UGUALI O SIMILI

Far associare le immagini uguali o simili.

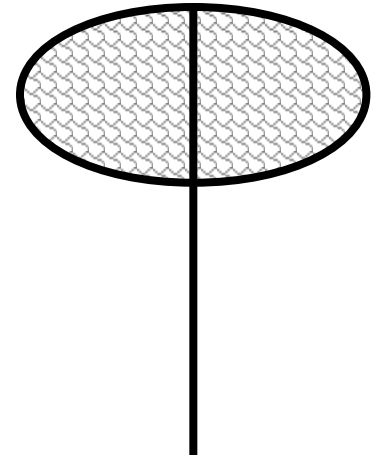
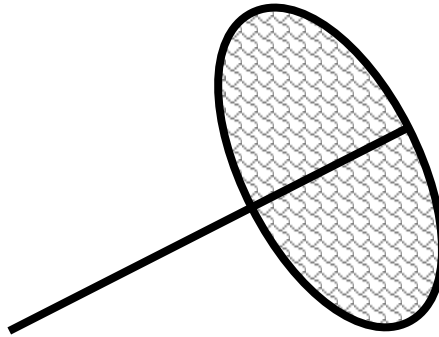
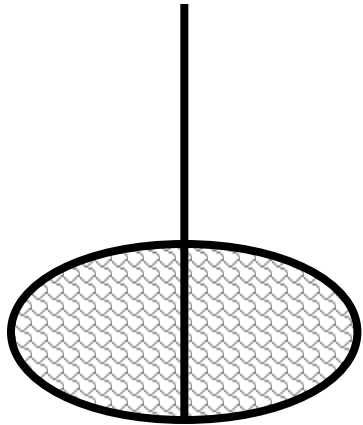
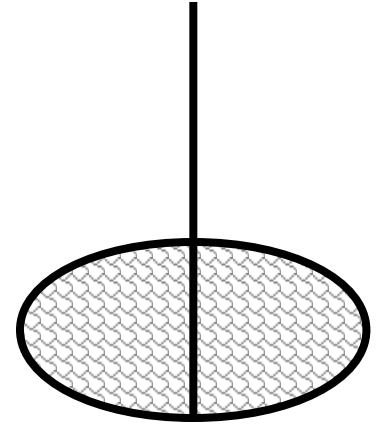
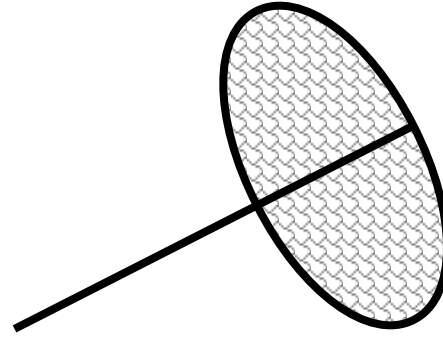
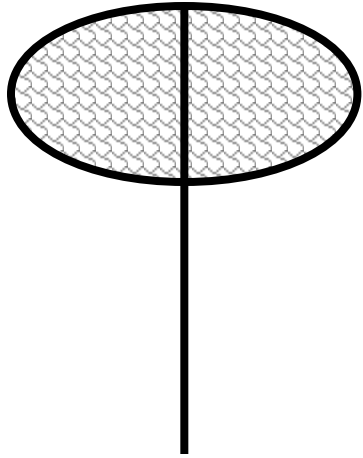

ASSOCIAZIONI DI IMMAGINI UGUALI O SIMILI

Far associare le immagini uguali o simili.

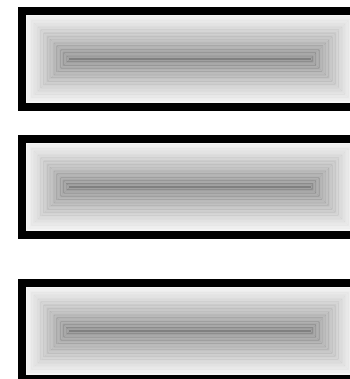
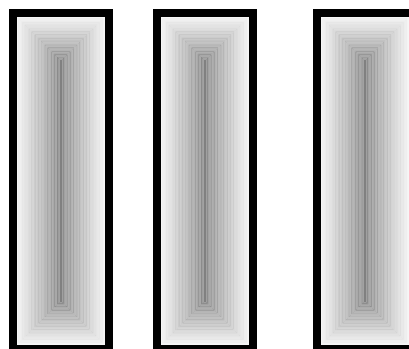
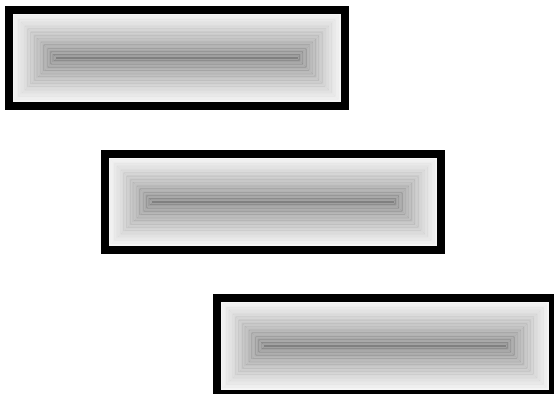
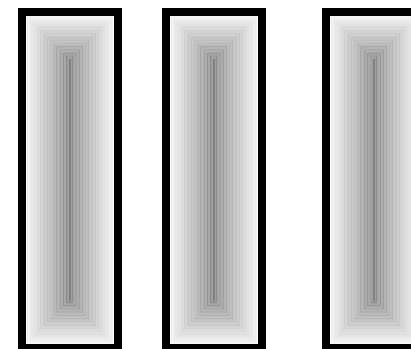
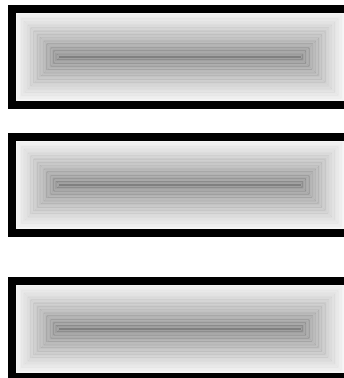
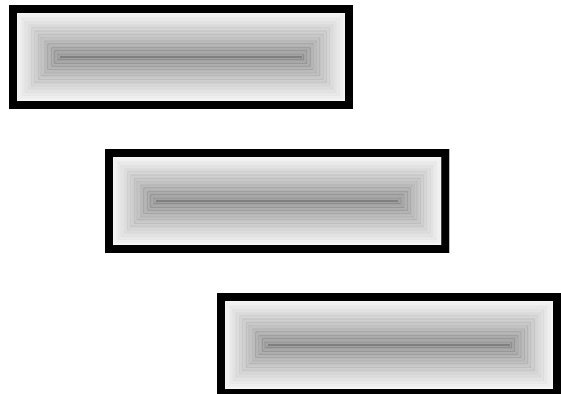

ASSOCIAZIONI DI IMMAGINI UGUALI O SIMILI

Far associare le immagini uguali o simili.

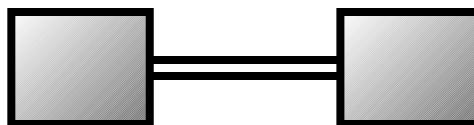
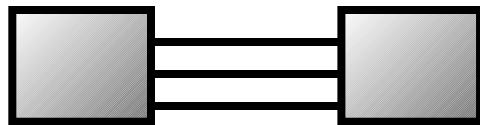
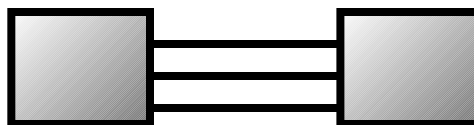
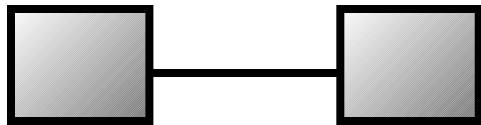

ASSOCIAZIONI DI IMMAGINI UGUALI O SIMILI

Far associare le immagini uguali o simili.

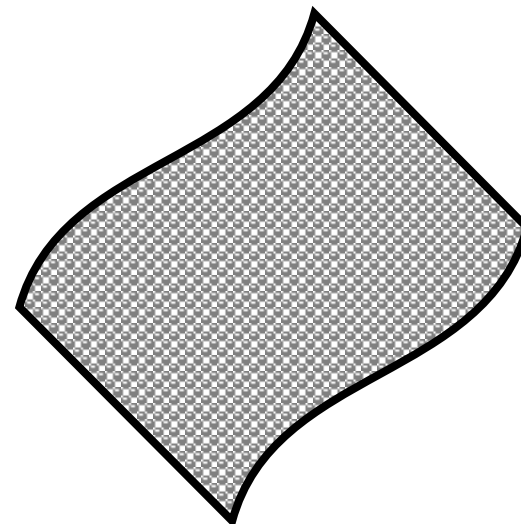
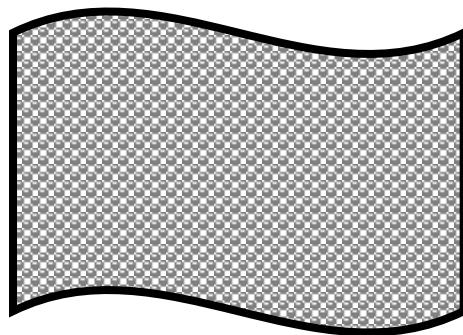
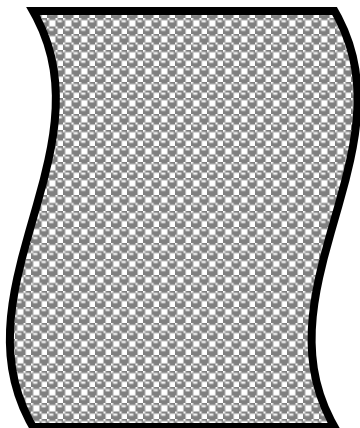
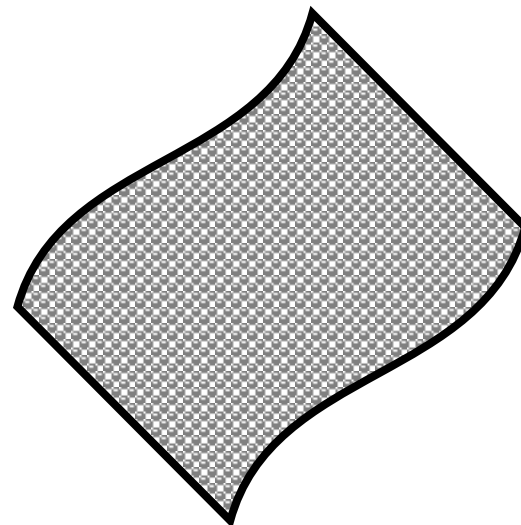
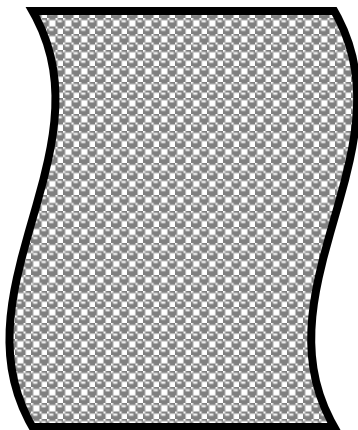
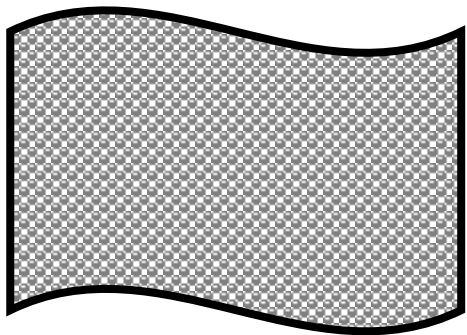

ASSOCIAZIONI DI IMMAGINI UGUALI O SIMILI

Far associare le immagini uguali o simili.



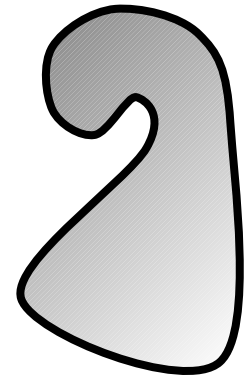
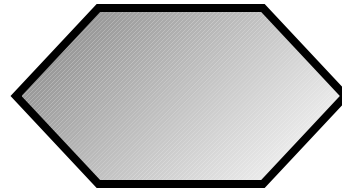
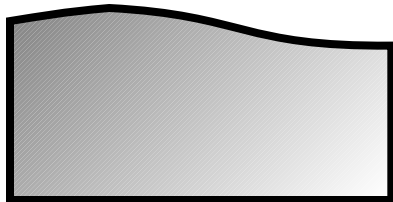
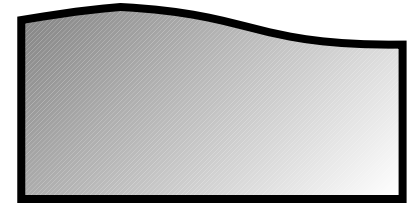
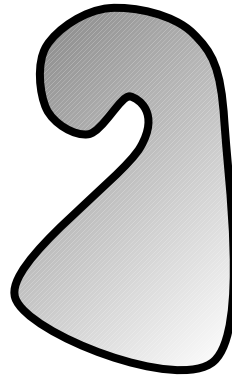
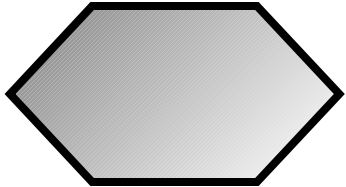

ASSOCIAZIONI DI IMMAGINI UGUALI O SIMILI

Far associare le immagini uguali o simili.

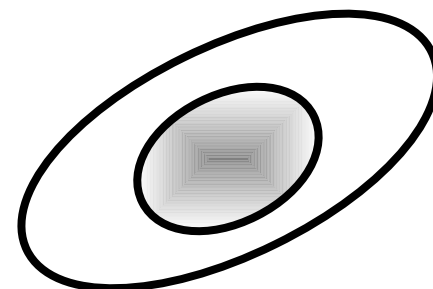
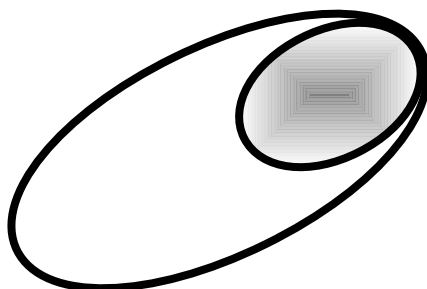
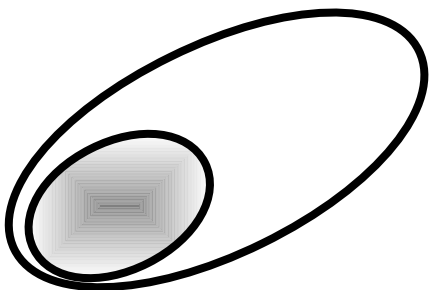
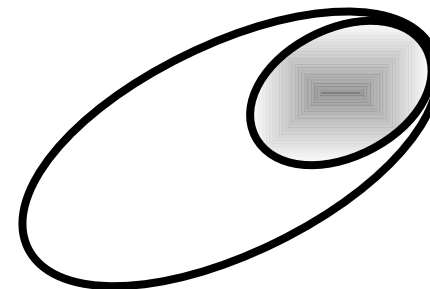
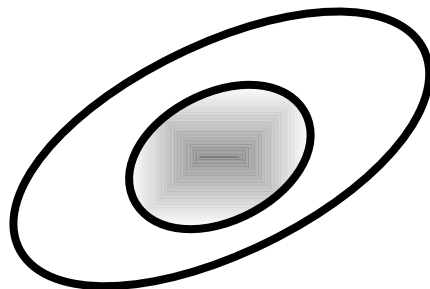
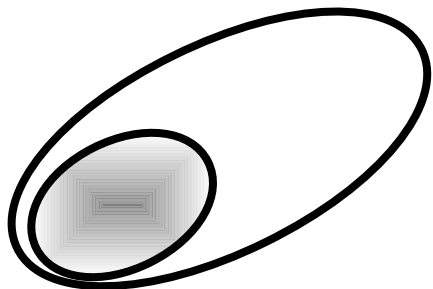

ASSOCIAZIONI DI IMMAGINI UGUALI O SIMILI

Far associare le immagini uguali o simili.

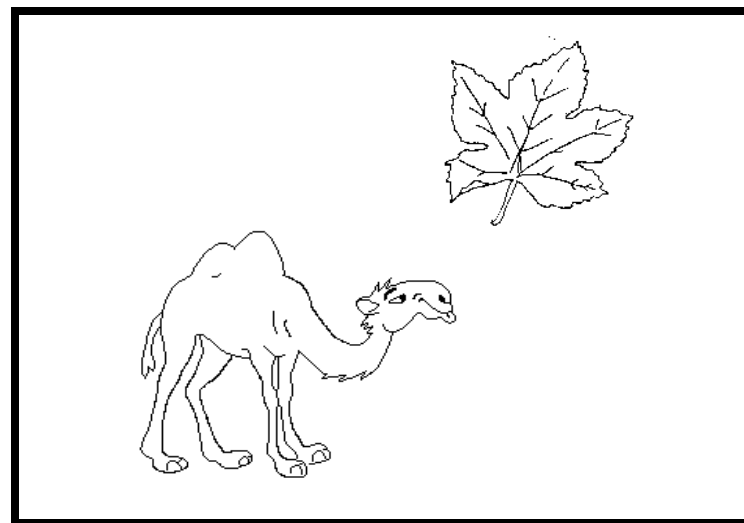
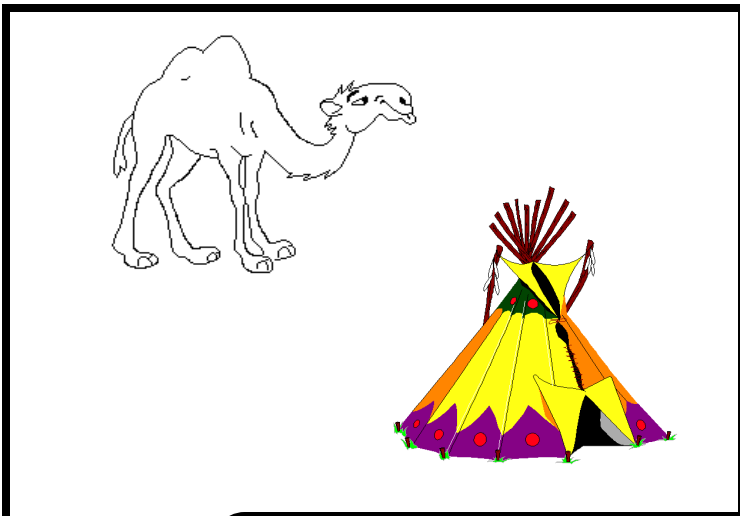
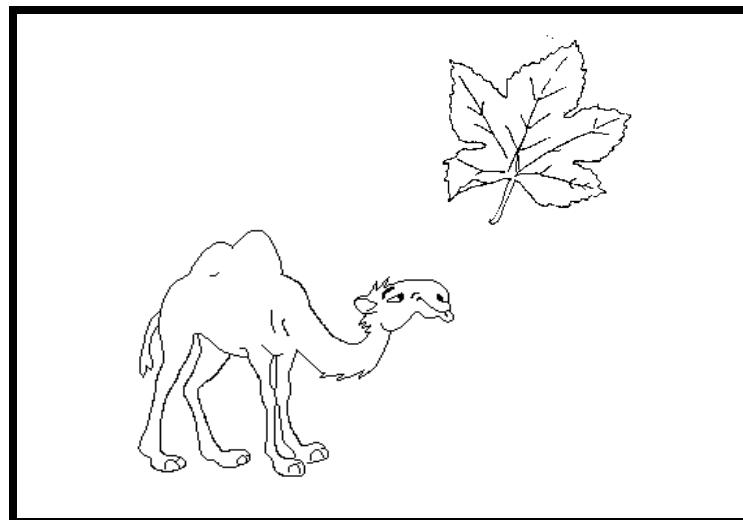
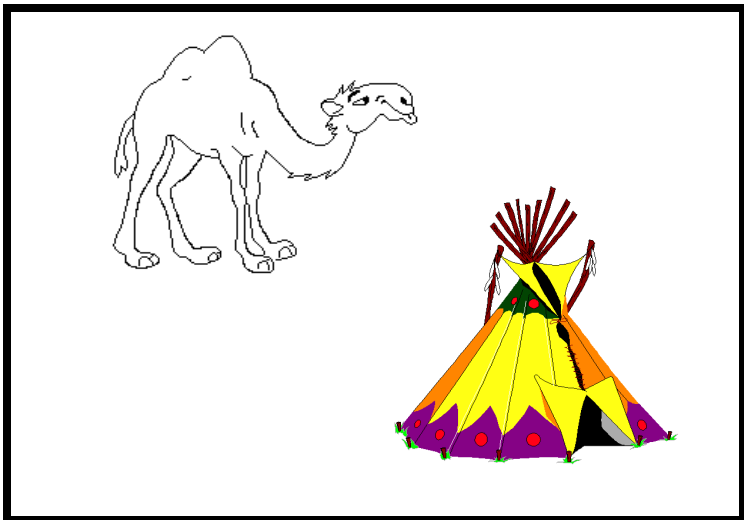

ASSOCIAZIONI DI IMMAGINI UGUALI O SIMILI

Far associare le immagini uguali o simili.

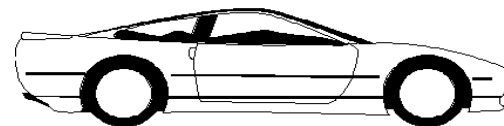
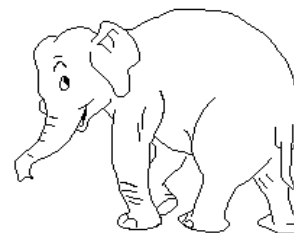
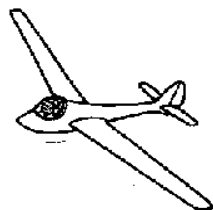
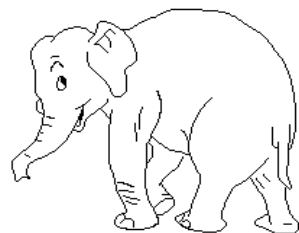
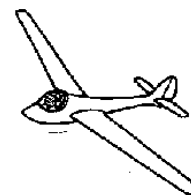
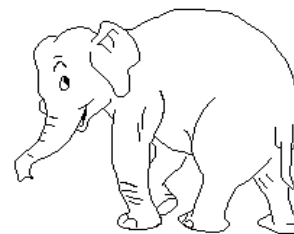
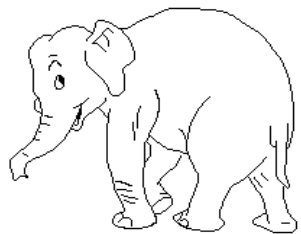

ASSOCIAZIONI DI IMMAGINI UGUALI O SIMILI

Far associare le immagini uguali o simili.

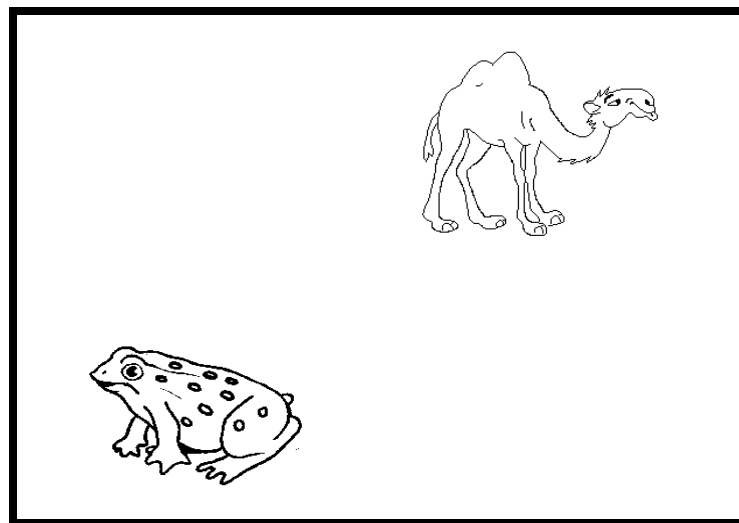
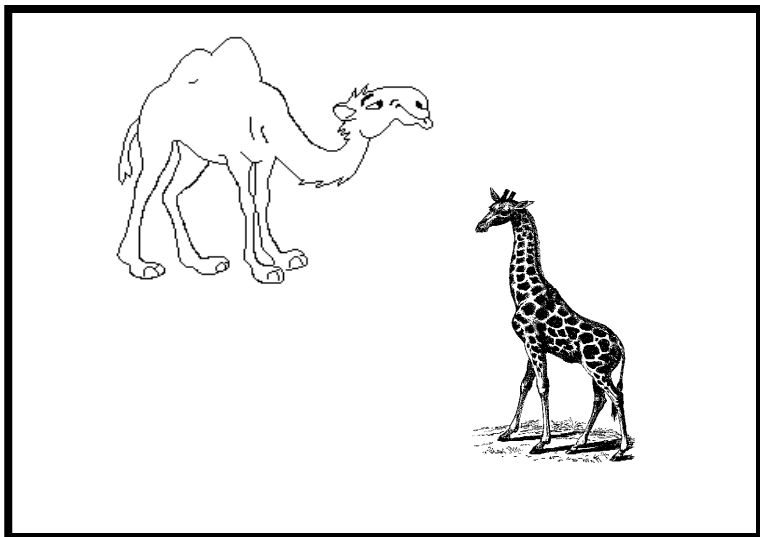
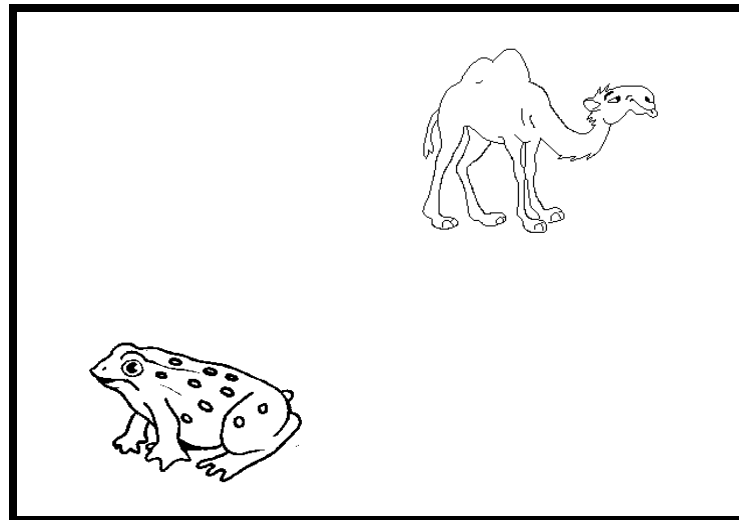
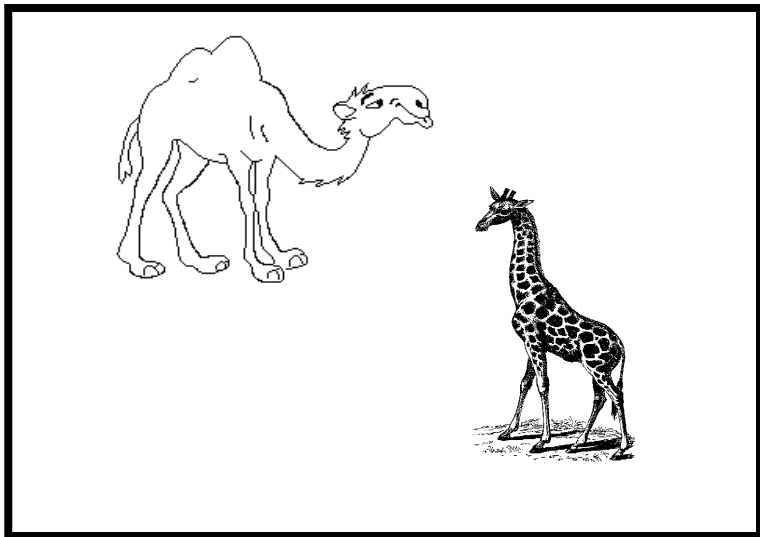

ASSOCIAZIONI DI IMMAGINI UGUALI O SIMILI

Far associare le immagini uguali o simili.

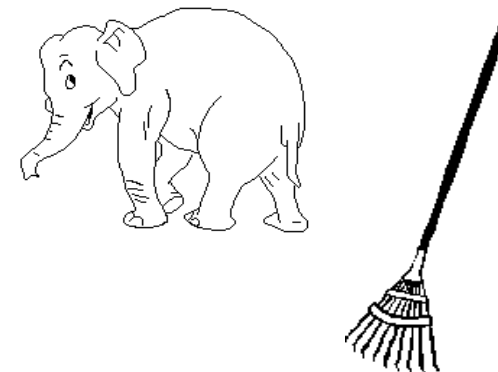
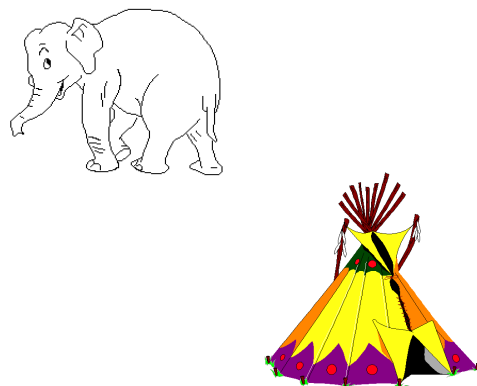
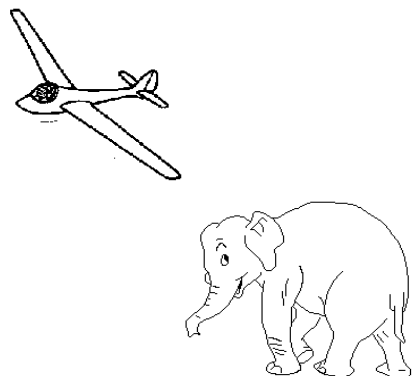
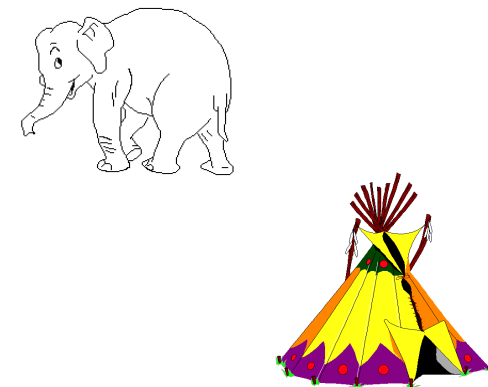
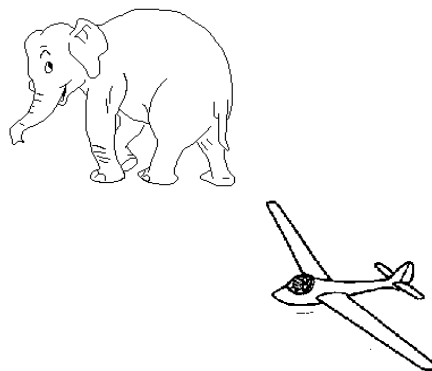
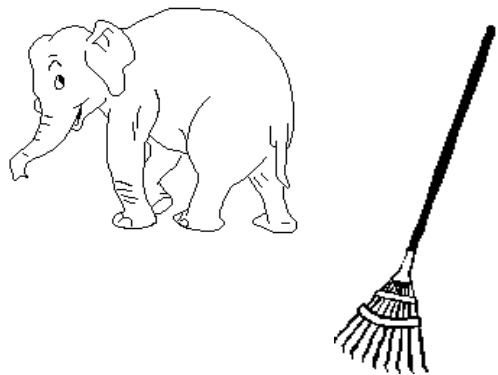

ASSOCIAZIONI DI IMMAGINI UGUALI O SIMILI

Far associare le immagini uguali o simili.

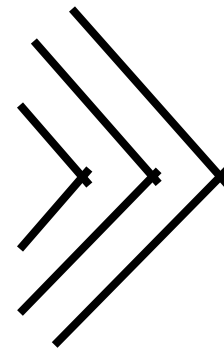
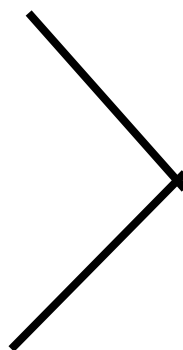
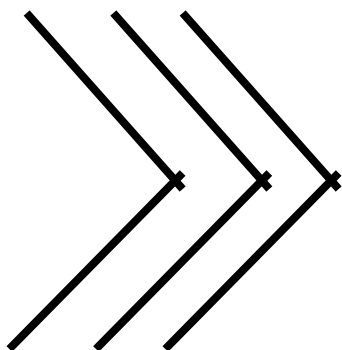
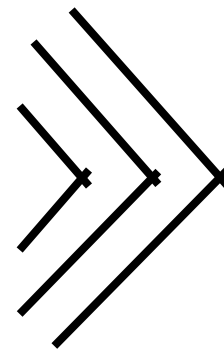
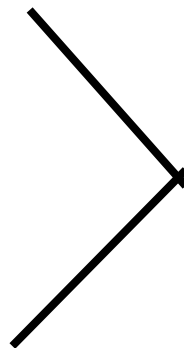
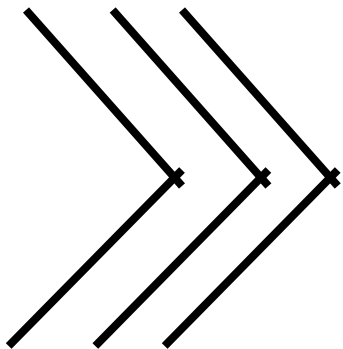

ASSOCIAZIONI DI IMMAGINI UGUALI O SIMILI

Far associare le immagini uguali o simili.

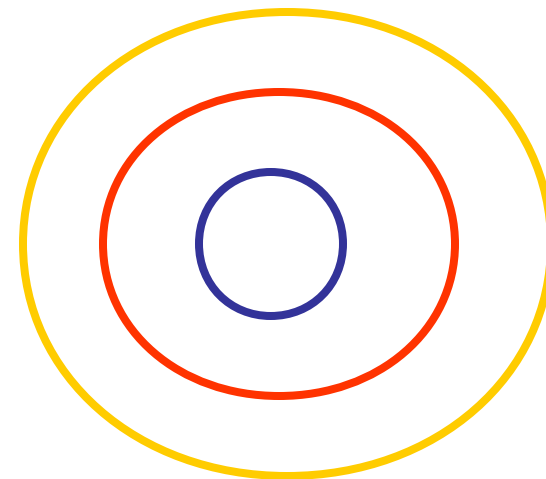
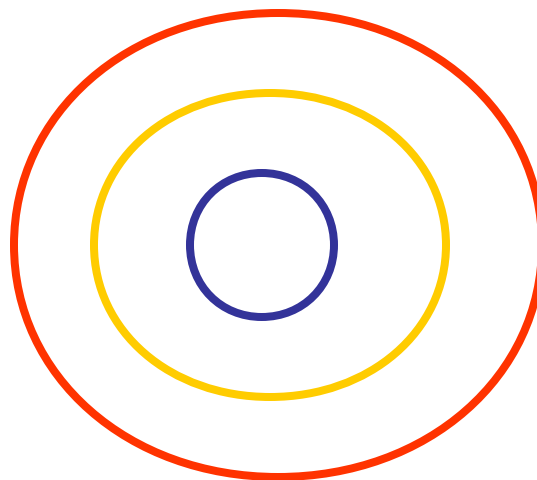
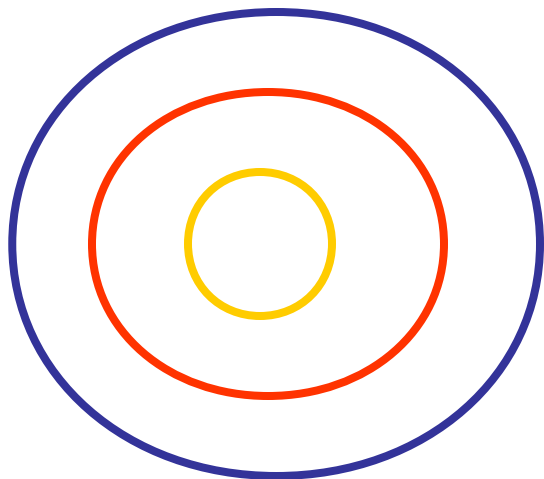
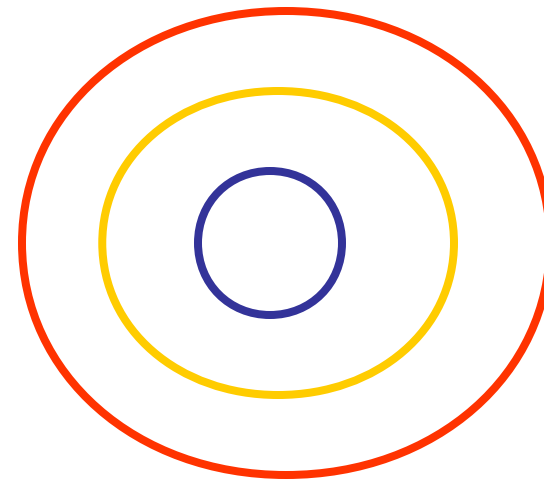
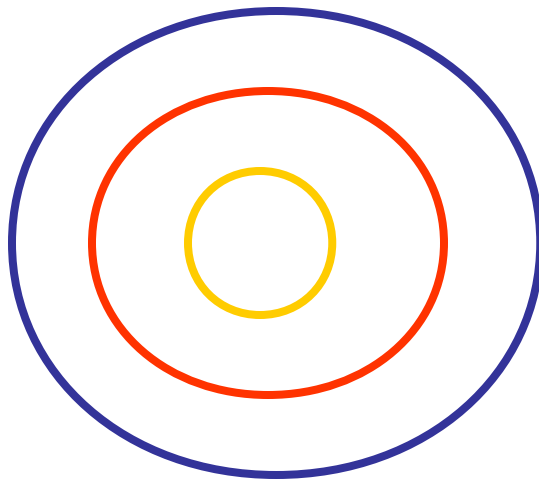
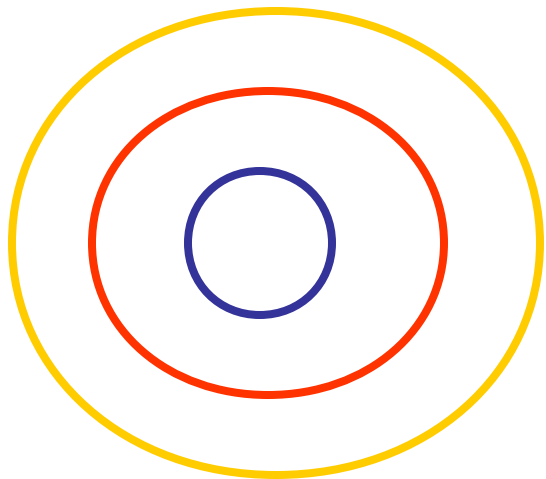

ASSOCIAZIONI DI IMMAGINI UGUALI O SIMILI

Far associare le immagini uguali o simili.



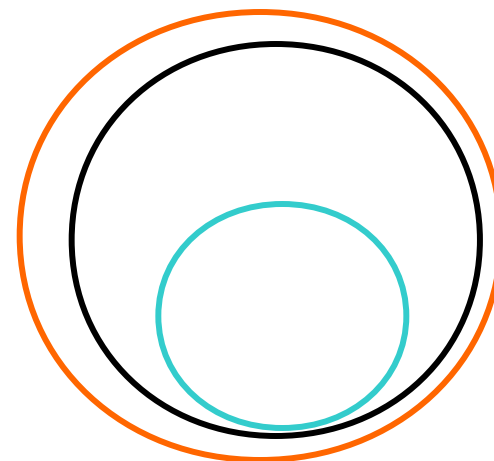
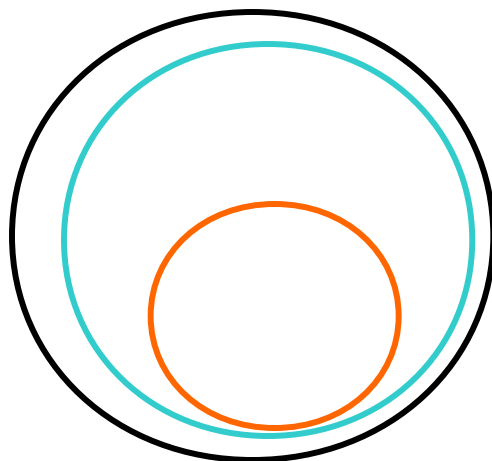
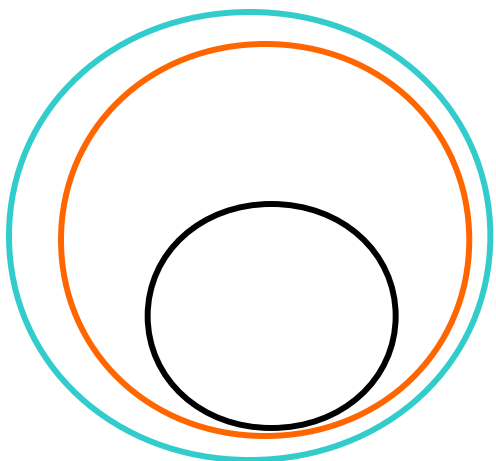
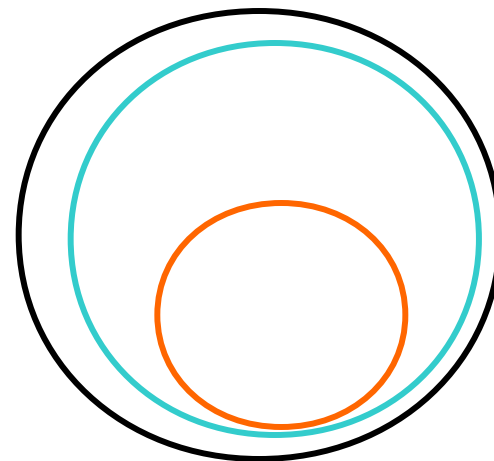
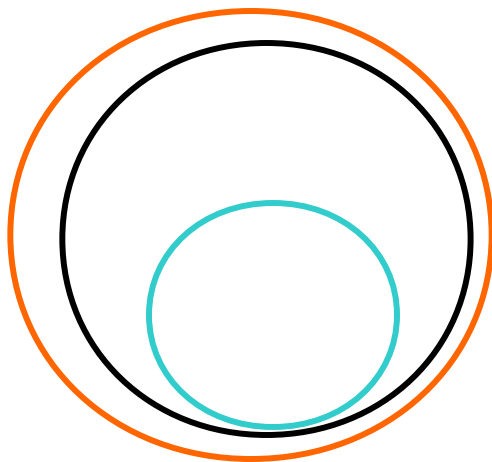
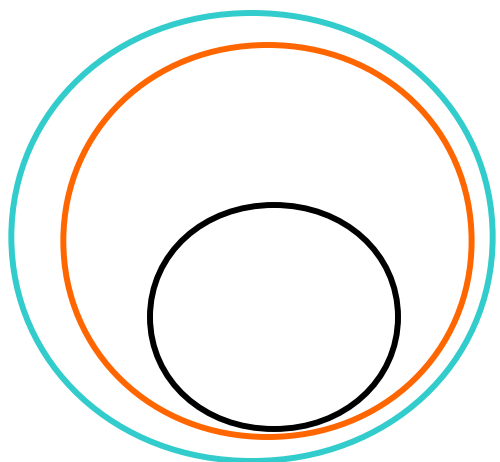

ASSOCIAZIONI DI IMMAGINI UGUALI O SIMILI

Far associare le immagini uguali o simili.

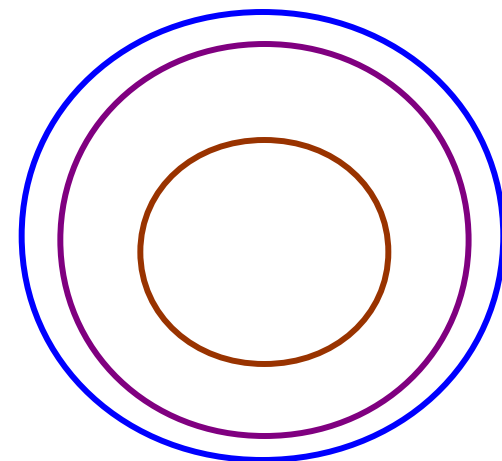
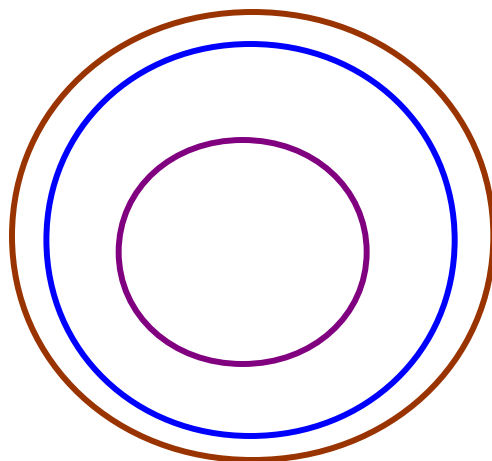
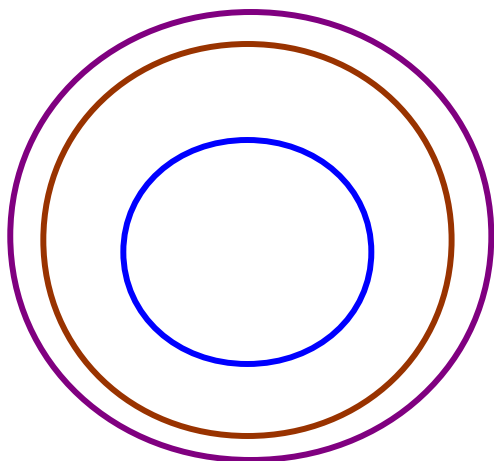
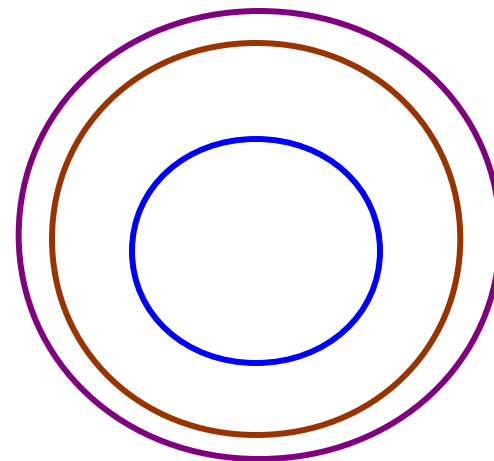
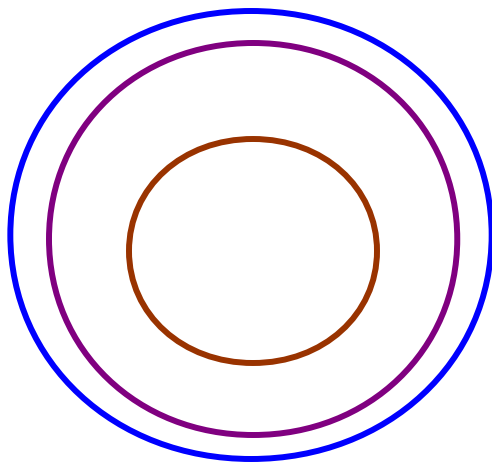
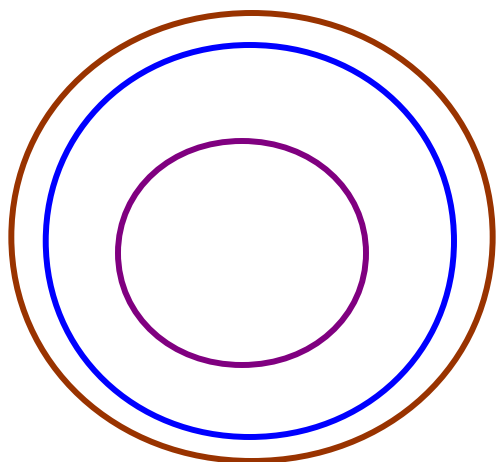

ASSOCIAZIONI DI IMMAGINI UGUALI O SIMILI

Far associare le immagini uguali o simili.

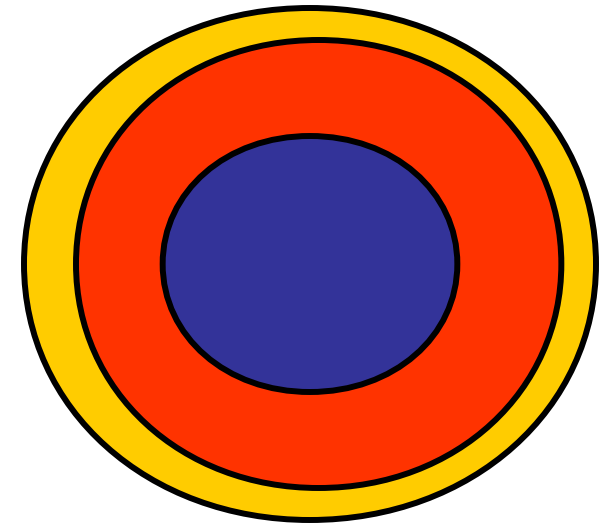
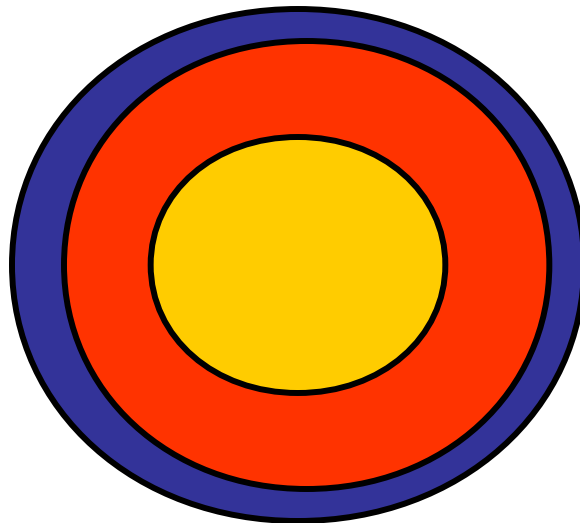
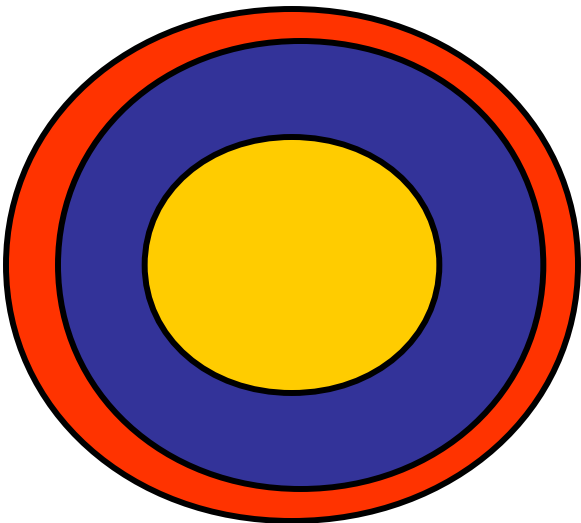
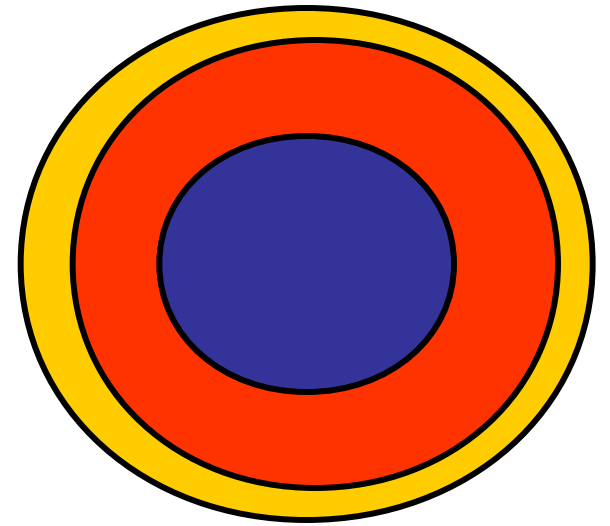
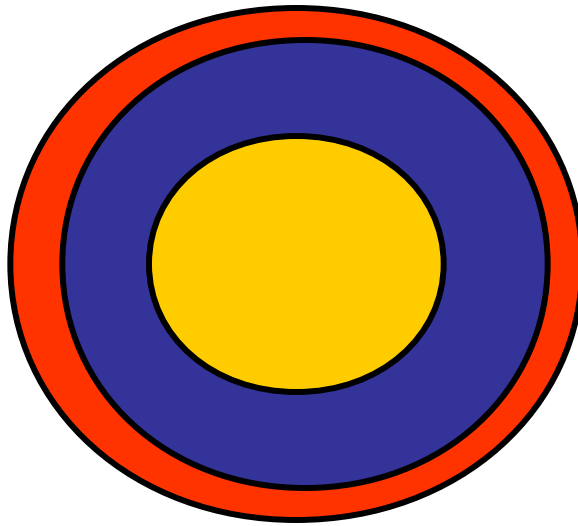
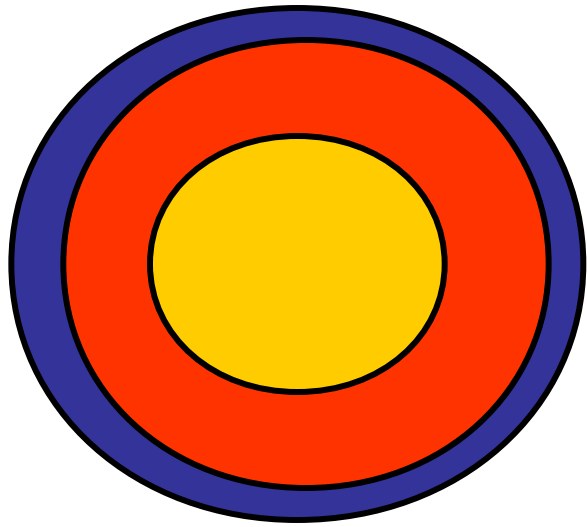

ASSOCIAZIONI DI IMMAGINI UGUALI O SIMILI

Far associare le immagini uguali o simili.

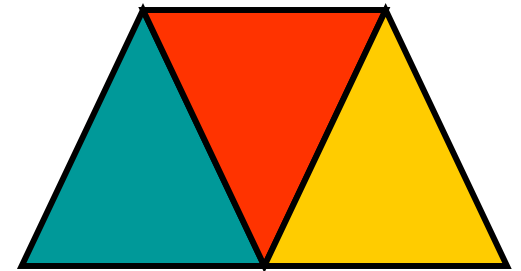
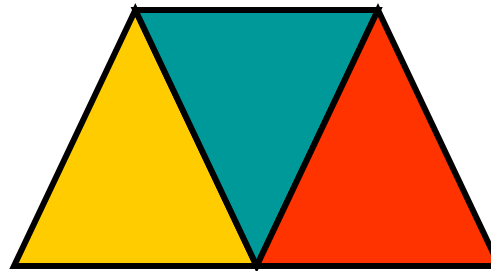
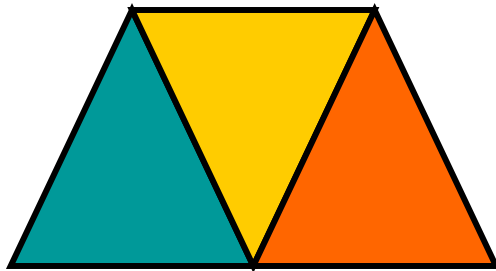
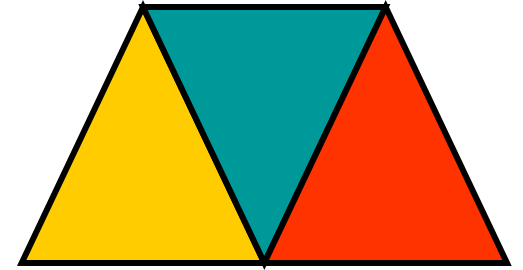
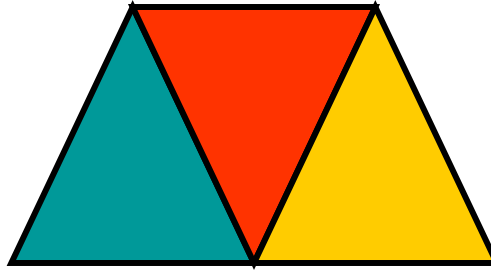
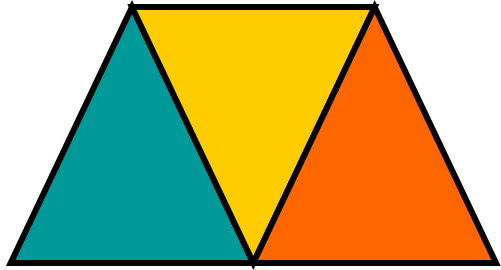

ASSOCIAZIONI DI IMMAGINI UGUALI O SIMILI

Far associare le immagini uguali o simili.

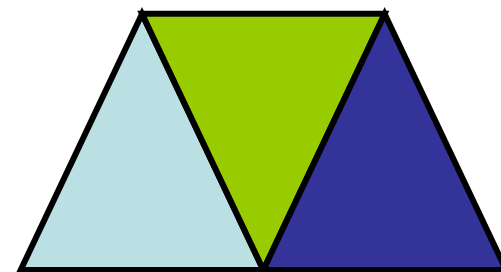
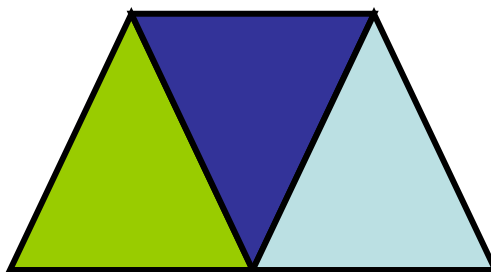
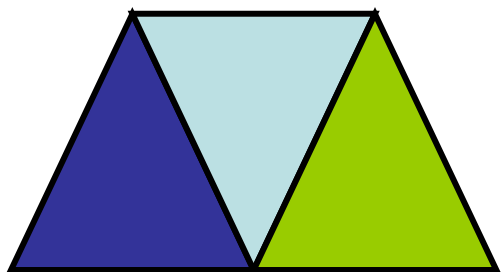
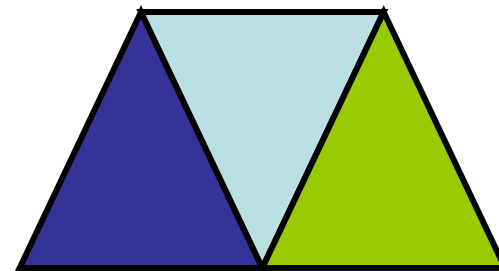
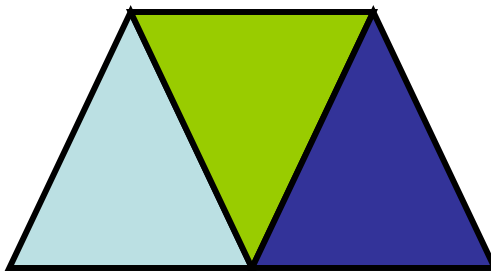
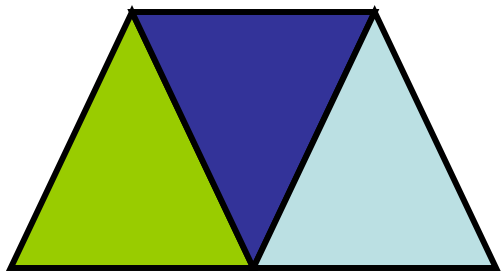

ASSOCIAZIONI DI IMMAGINI UGUALI O SIMILI

Far associare le immagini uguali o simili.

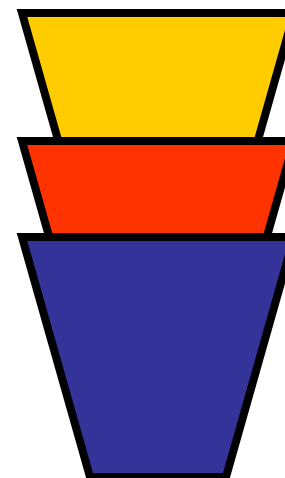
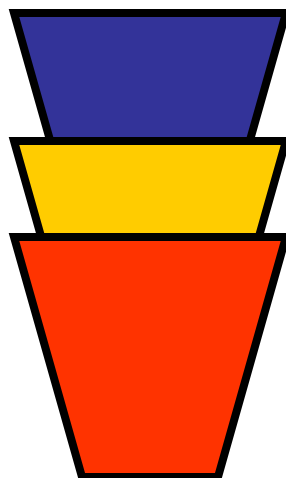
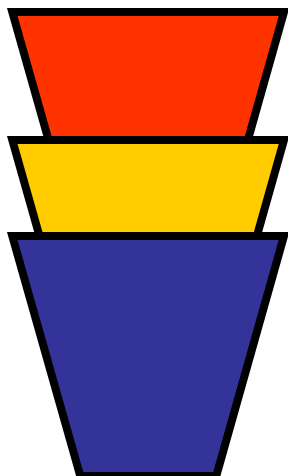
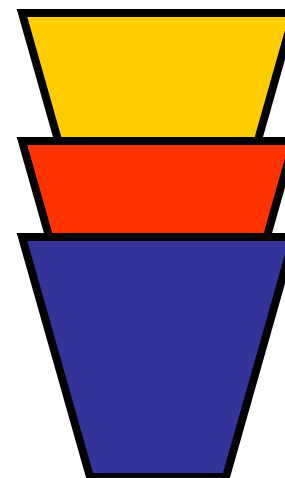
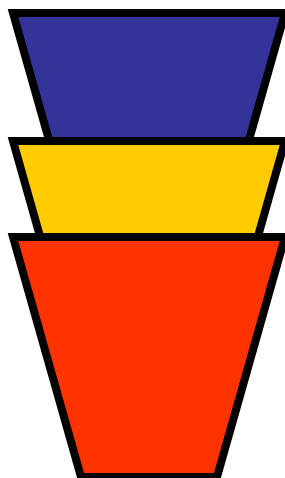
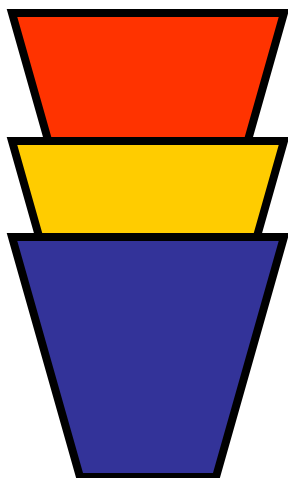

ASSOCIAZIONI DI IMMAGINI UGUALI O SIMILI

Far associare le immagini uguali o simili.

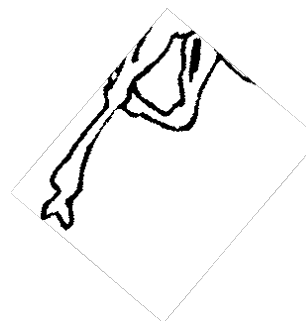
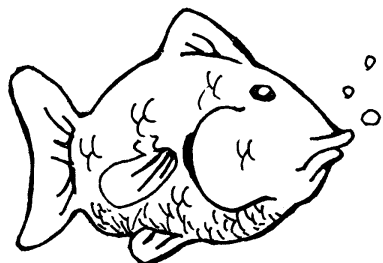
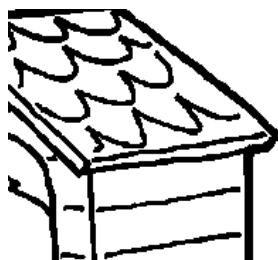
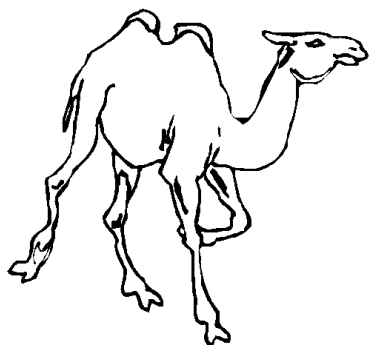
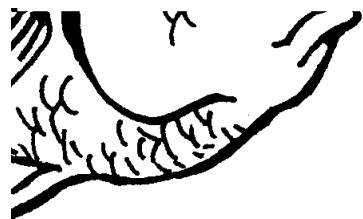
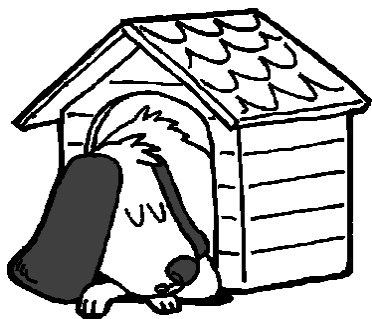

ASSOCIAZIONI DI IMMAGINI UGUALI O SIMILI

Far associare le immagini uguali o simili.

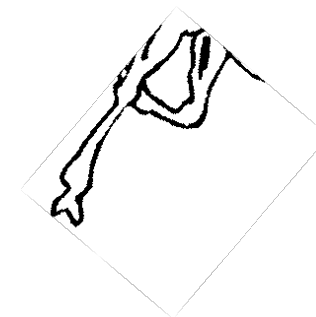
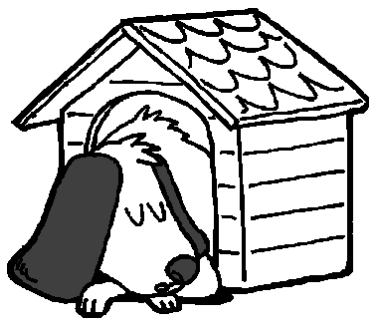
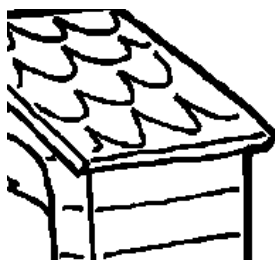
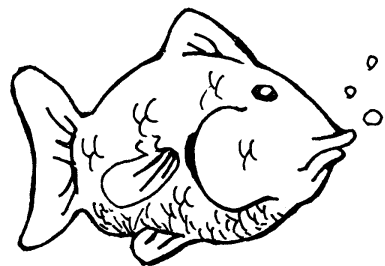
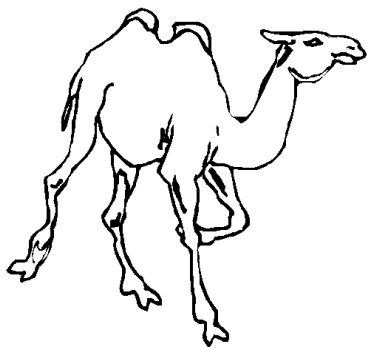

ASSOCIAZIONI DI IMMAGINI UGUALI O SIMILI

Far associare le immagini uguali o simili.



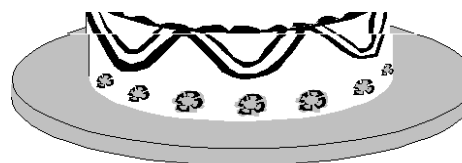
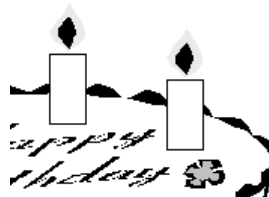
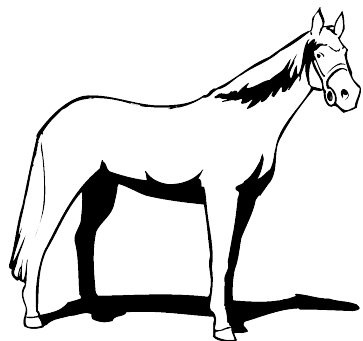
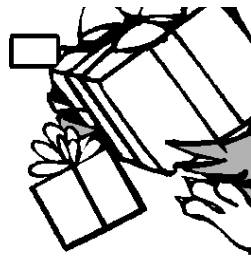

ASSOCIAZIONI DI IMMAGINI UGUALI O SIMILI

Far associare le immagini uguali o simili.

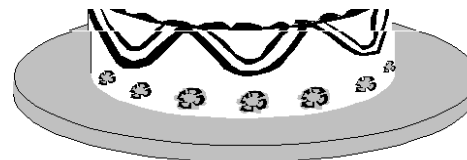
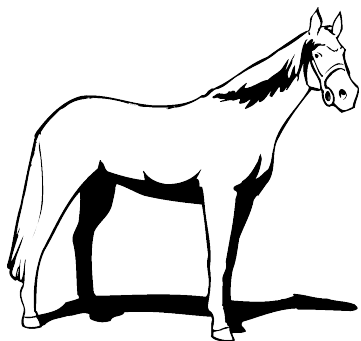

ASSOCIAZIONI DI IMMAGINI UGUALI O SIMILI

Far associare le immagini uguali o simili.

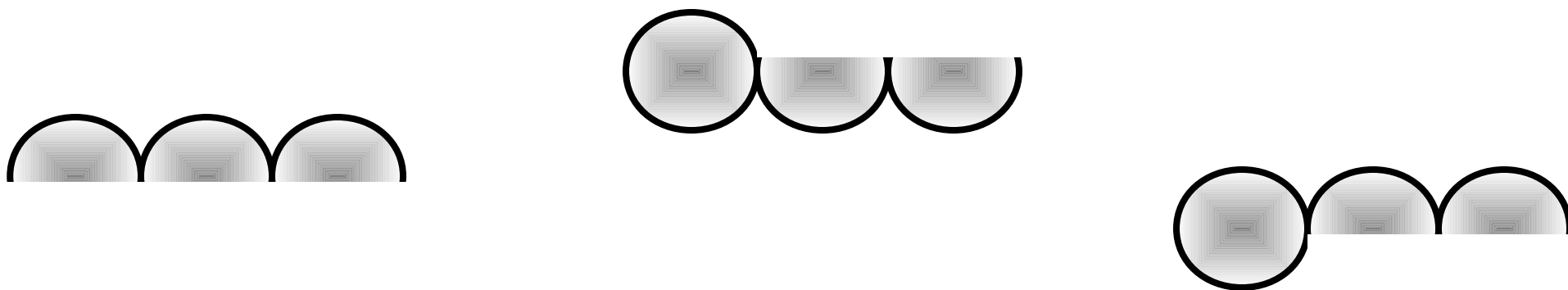
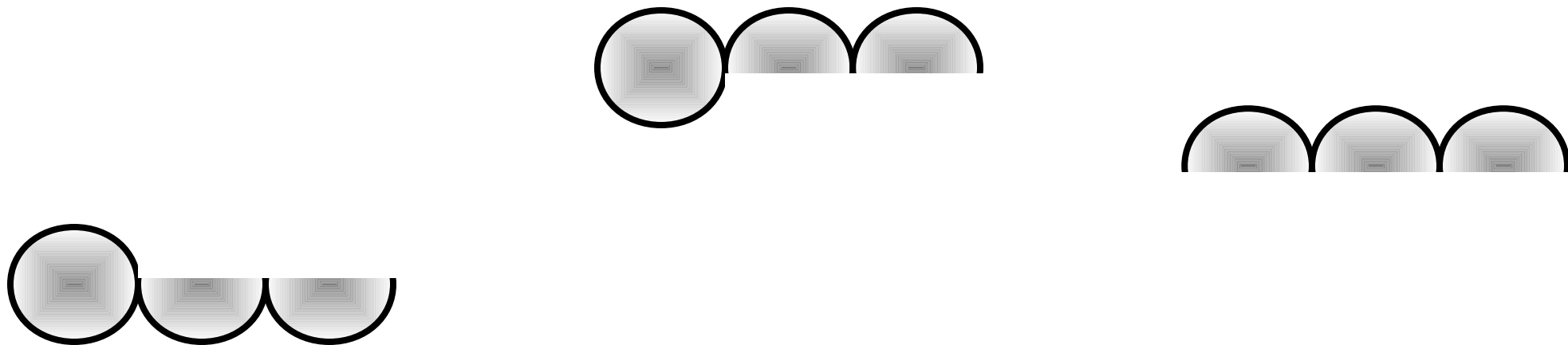

ASSOCIAZIONI DI IMMAGINI UGUALI O SIMILI

Far associare le immagini uguali o simili.

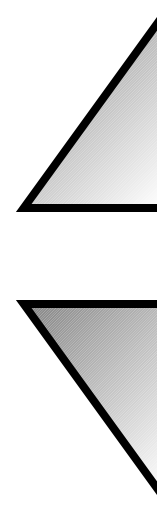
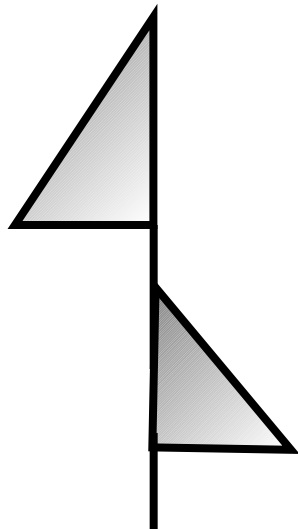
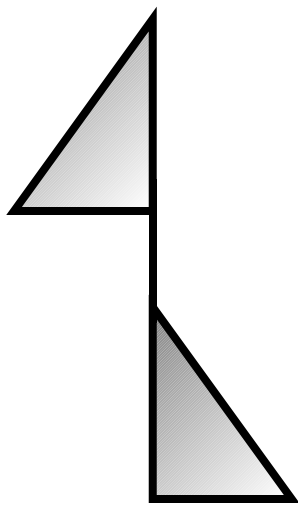
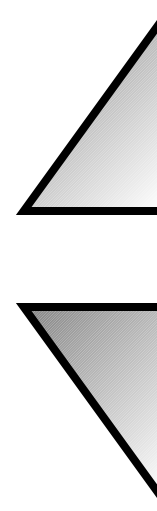
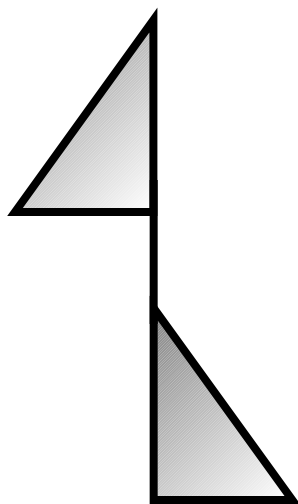
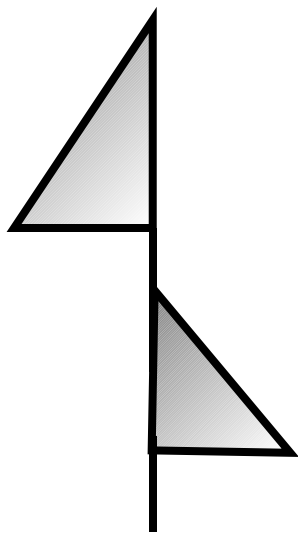

ASSOCIAZIONI DI IMMAGINI UGUALI O SIMILI

Far associare le immagini uguali o simili.

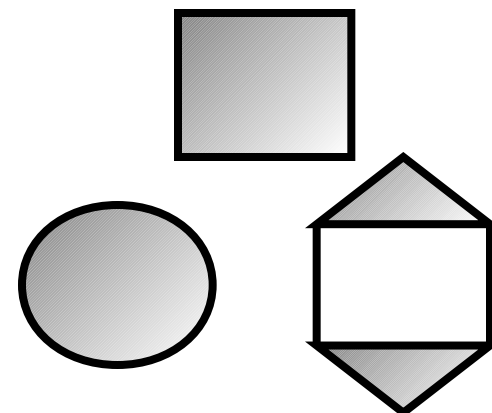
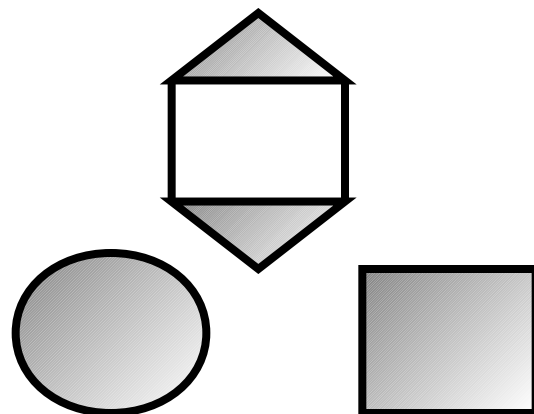
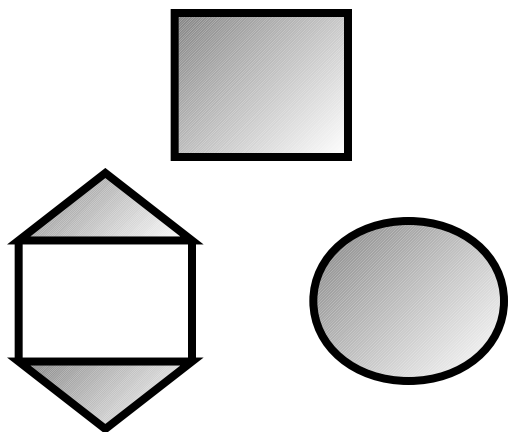
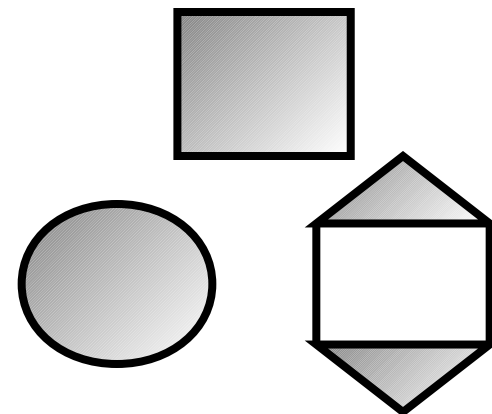
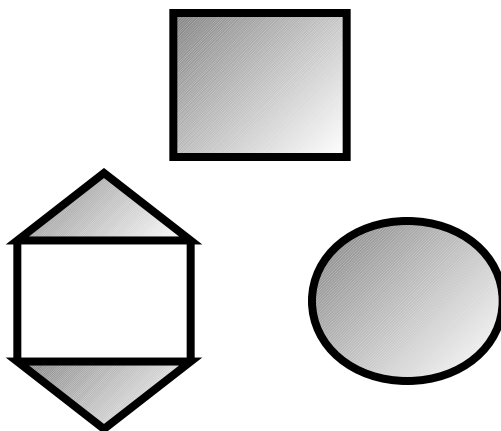
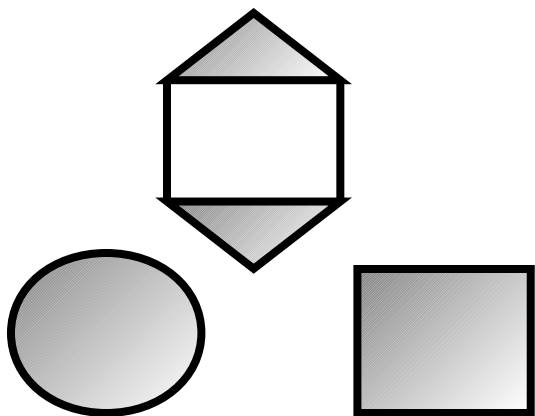

ASSOCIAZIONI DI IMMAGINI UGUALI O SIMILI

Far associare le immagini uguali o simili.

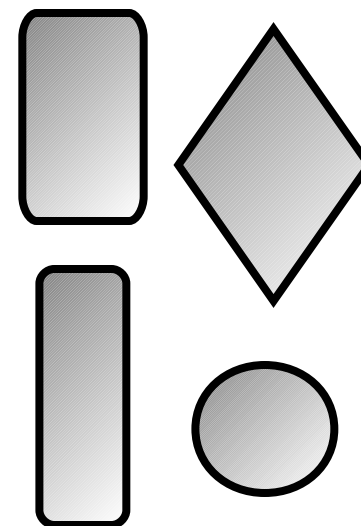
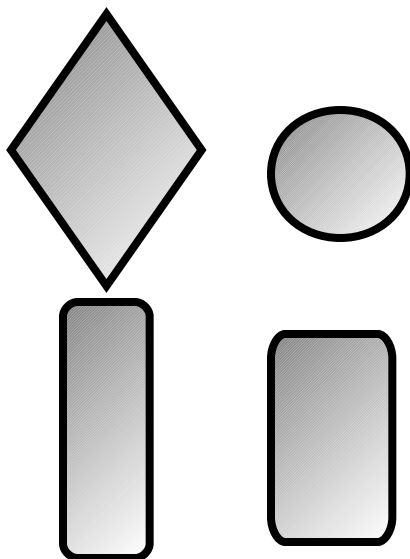
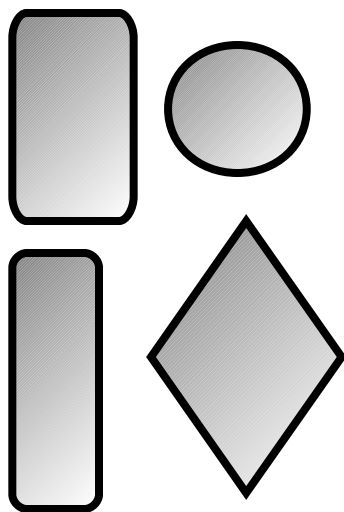
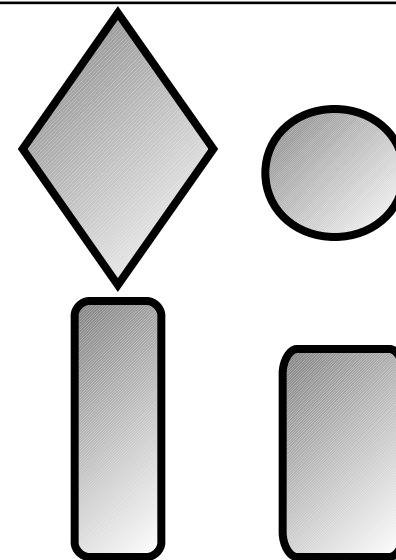
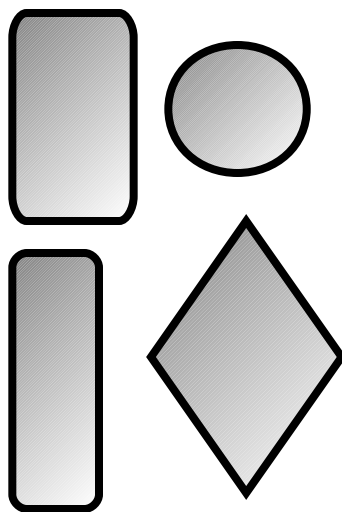
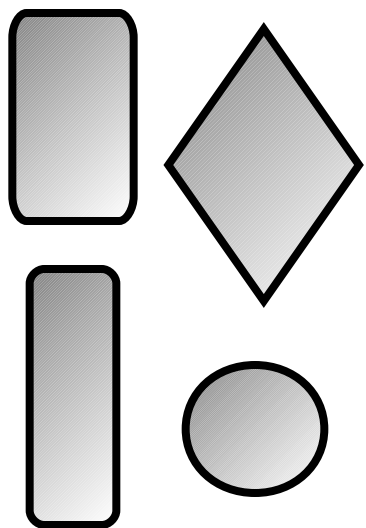

ASSOCIAZIONI DI IMMAGINI UGUALI O SIMILI

Far associare le immagini uguali o simili.

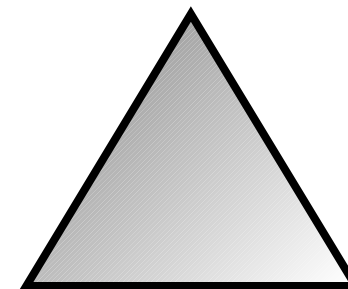
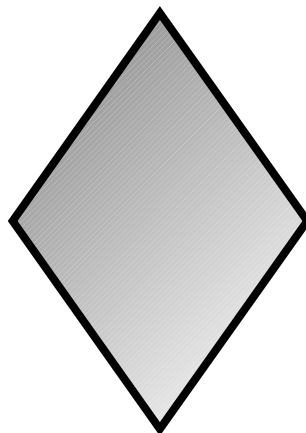
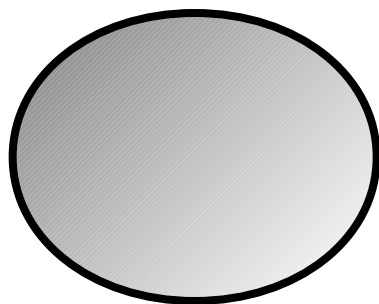
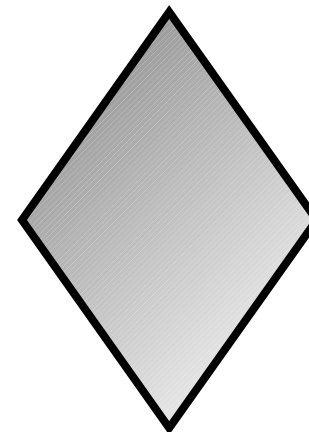
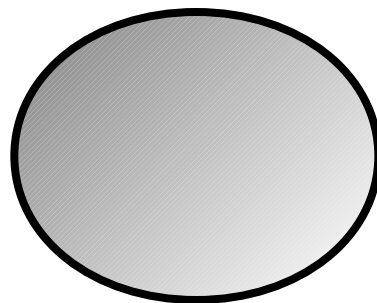
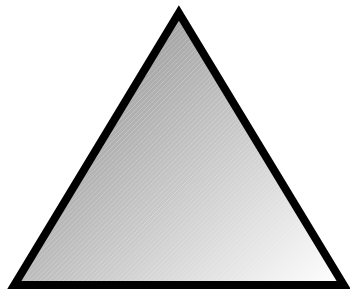

ASSOCIAZIONI DI IMMAGINI UGUALI O SIMILI

Far associare le immagini uguali o simili.

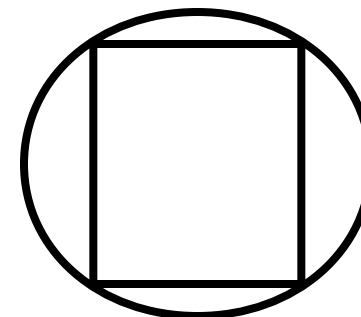
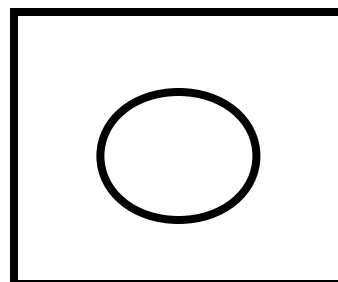
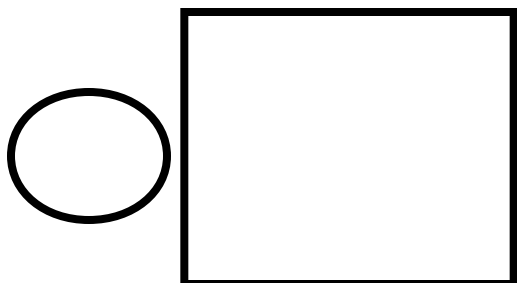
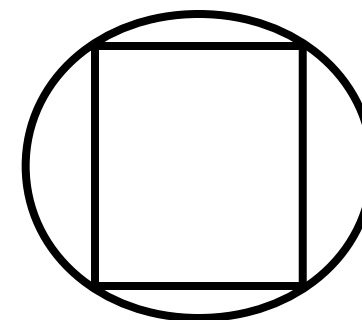
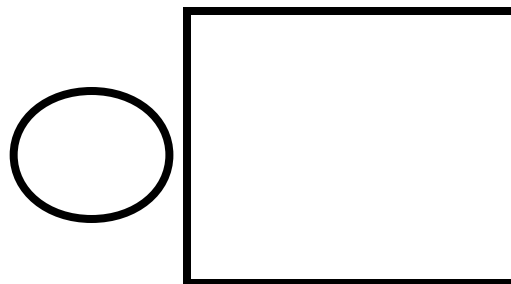
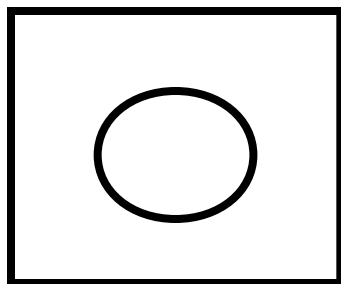

ASSOCIAZIONI DI IMMAGINI UGUALI O SIMILI

Far associare le immagini uguali o simili.



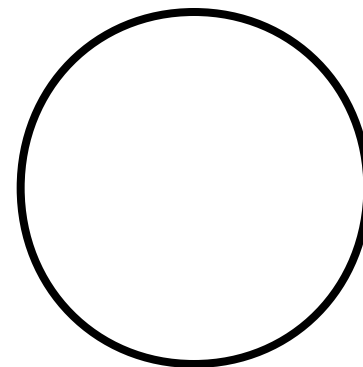
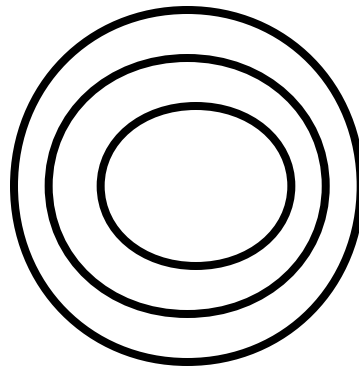
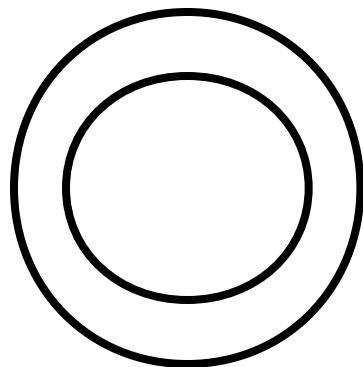
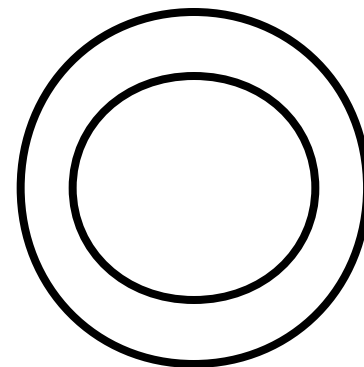
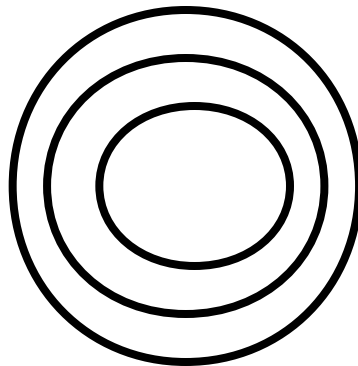
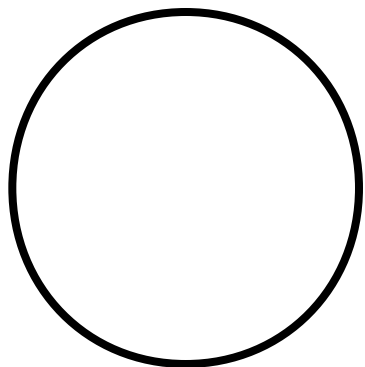

ASSOCIAZIONI DI IMMAGINI UGUALI O SIMILI

Far associare le immagini uguali o simili.

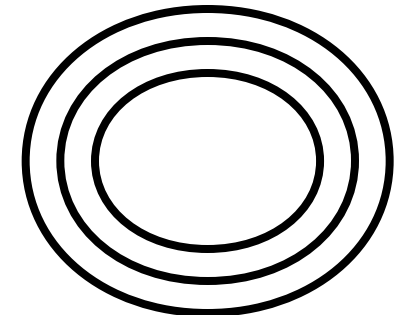
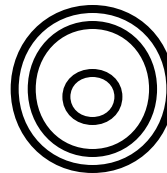
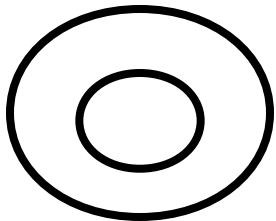
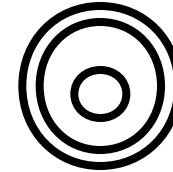
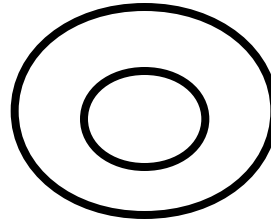
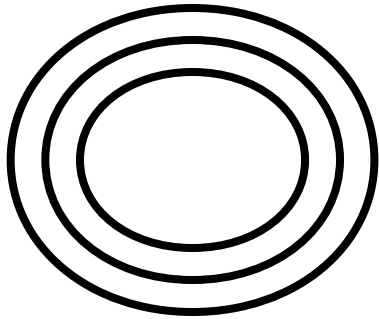

ASSOCIAZIONI DI IMMAGINI UGUALI O SIMILI

Far associare le immagini uguali o simili.

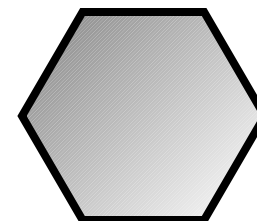
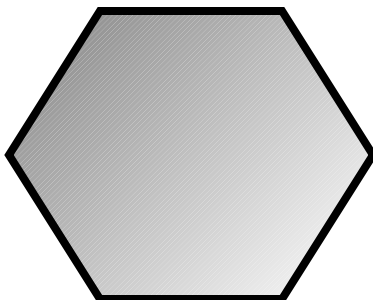
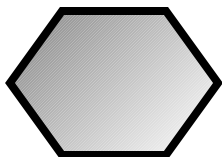
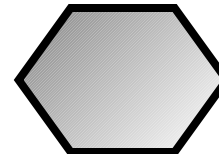
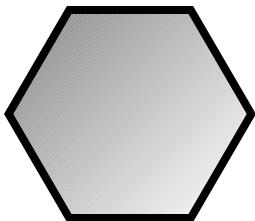
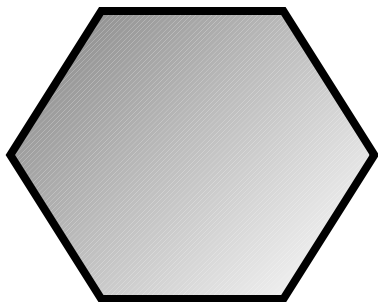

ASSOCIAZIONI DI IMMAGINI UGUALI O SIMILI

Far associare le immagini uguali o simili.

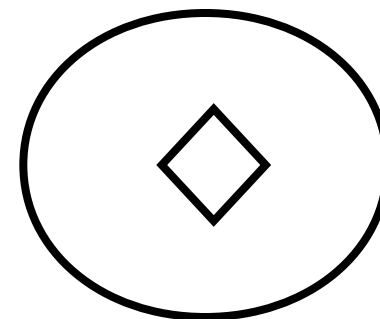
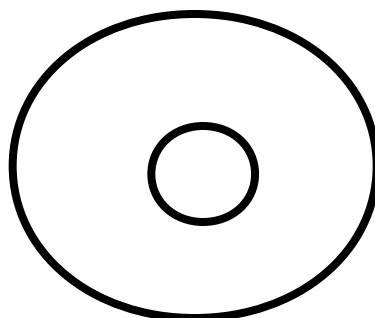
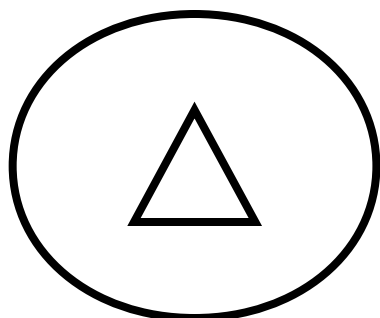
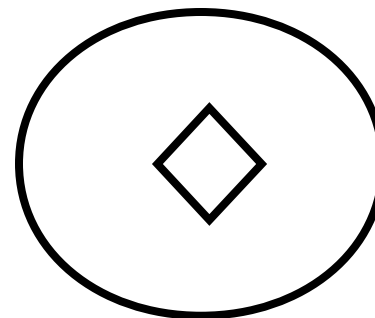
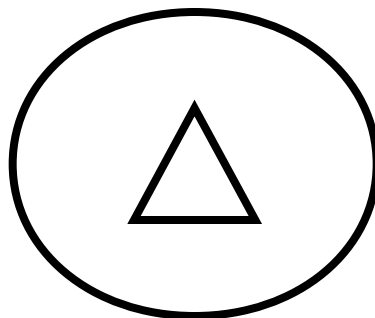
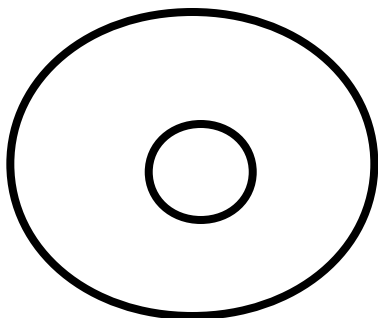

ASSOCIAZIONI DI IMMAGINI UGUALI O SIMILI

Far associare le immagini uguali o simili.

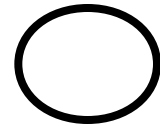
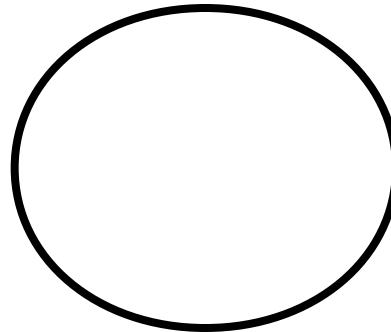
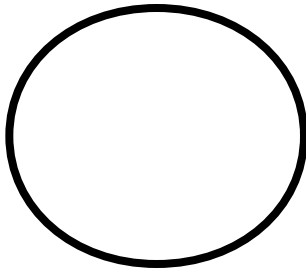
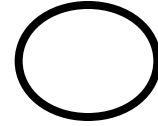
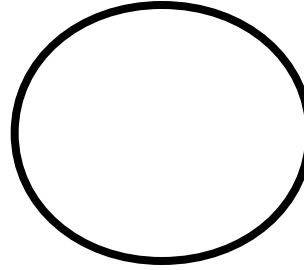
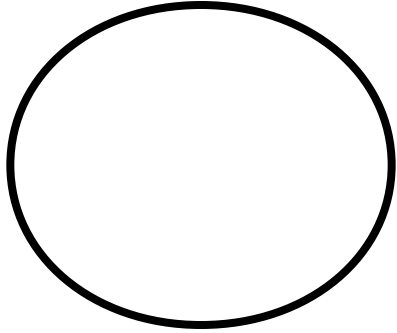

ASSOCIAZIONI DI IMMAGINI UGUALI O SIMILI

Far associare le immagini uguali o simili.

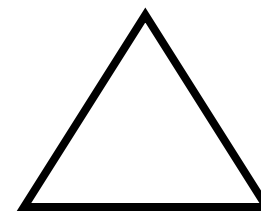
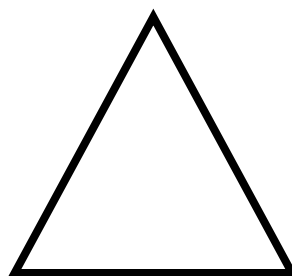
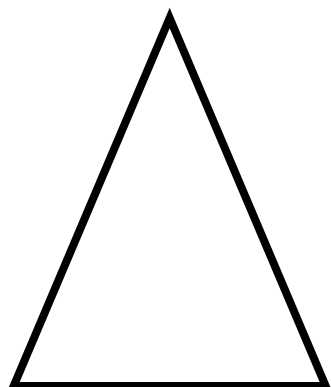
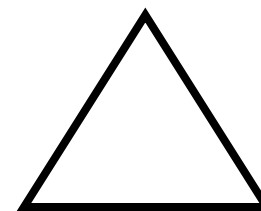
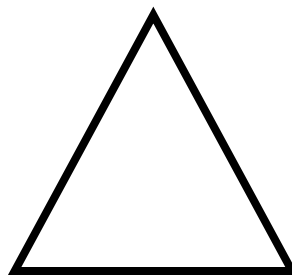
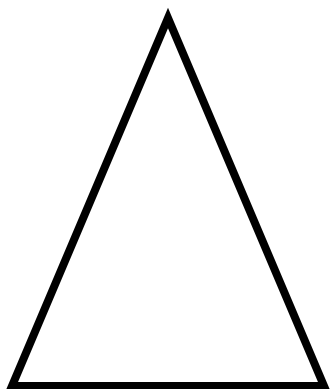

ASSOCIAZIONI DI IMMAGINI UGUALI O SIMILI

Far associare le immagini uguali o simili.

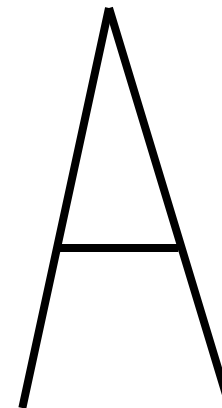
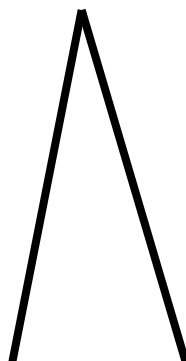
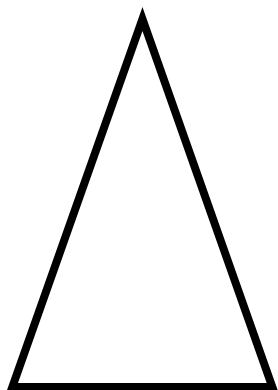
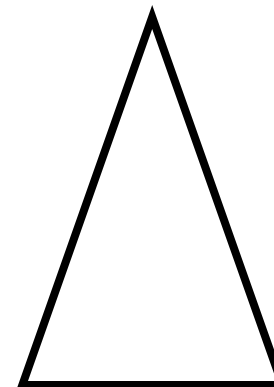
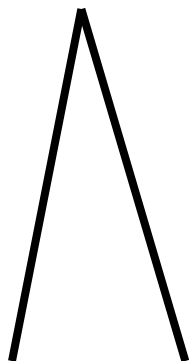
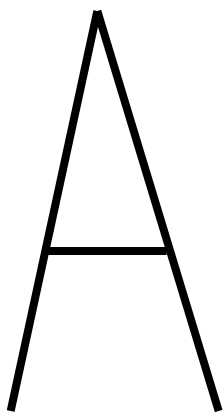

ASSOCIAZIONI DI IMMAGINI UGUALI O SIMILI

Far associare le immagini uguali o simili.

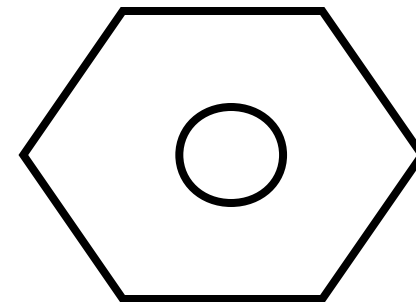
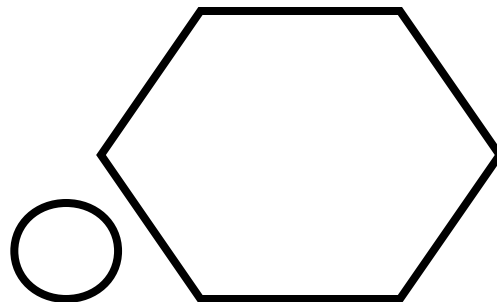
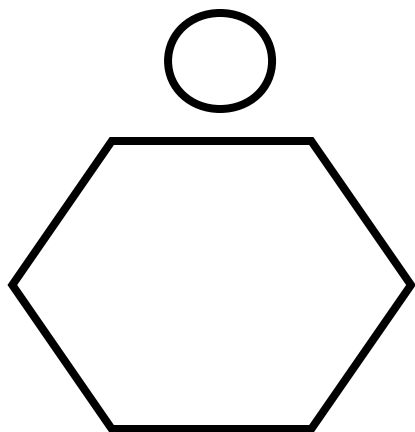
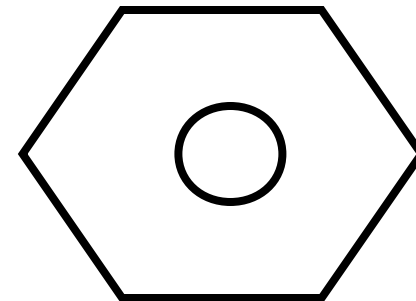
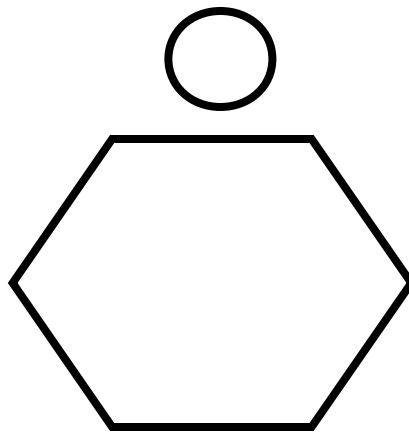
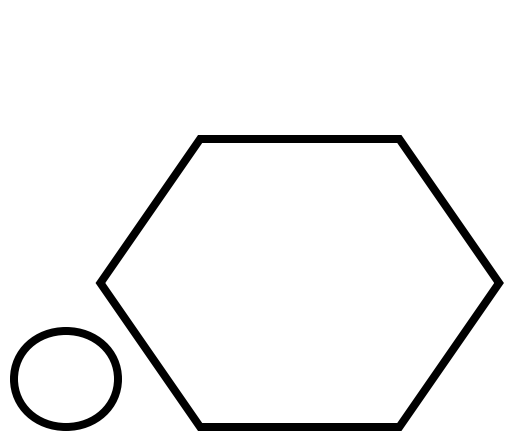

ASSOCIAZIONI DI IMMAGINI UGUALI O SIMILI

Far associare le immagini uguali o simili.



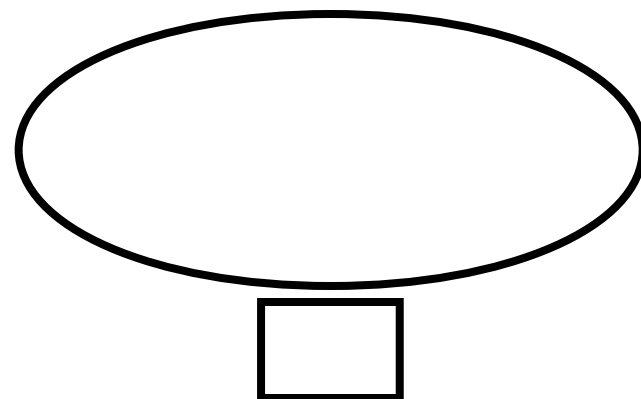
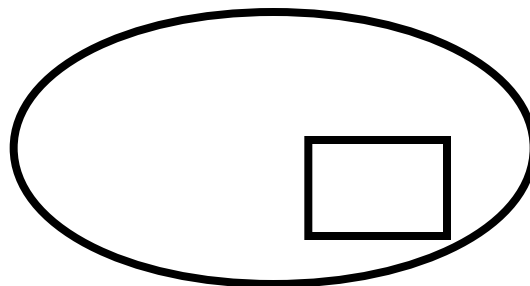
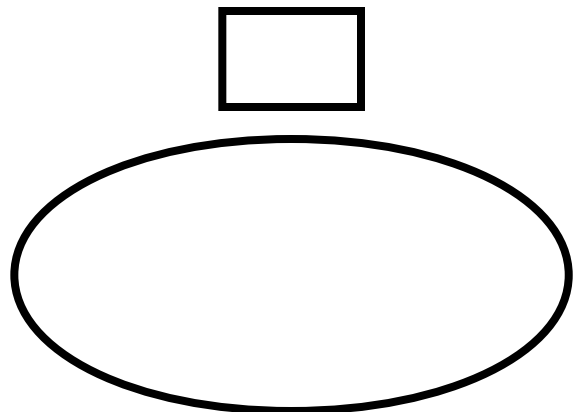
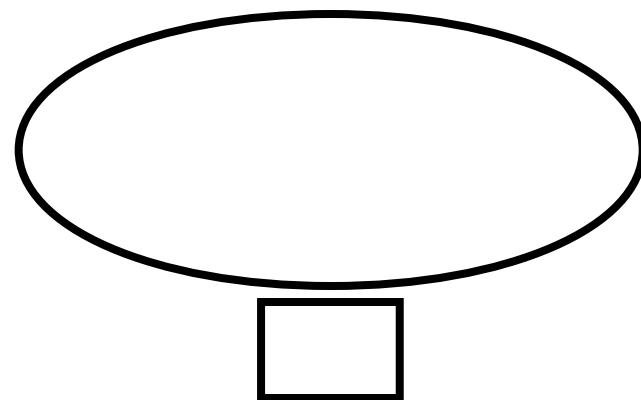
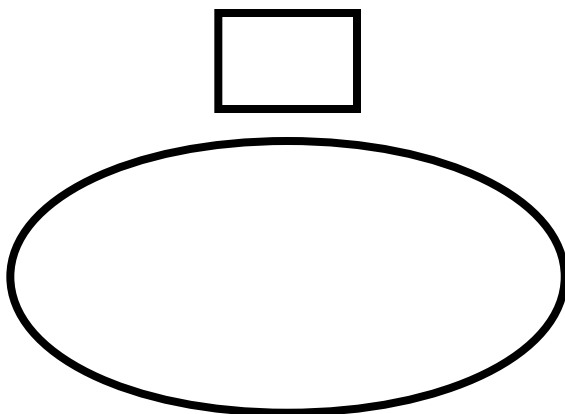
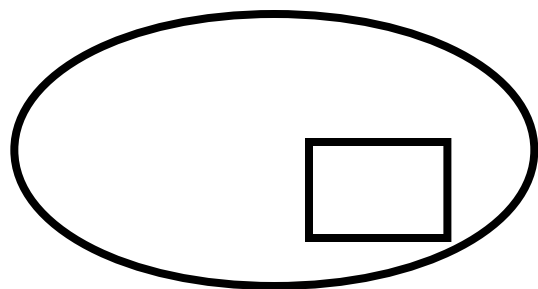

ASSOCIAZIONI DI IMMAGINI UGUALI O SIMILI

Far associare le immagini uguali o simili.

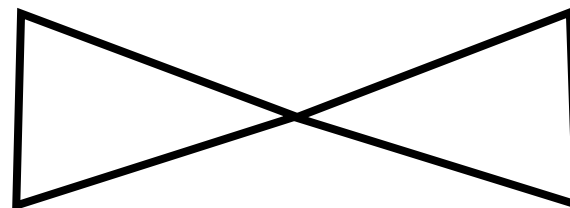
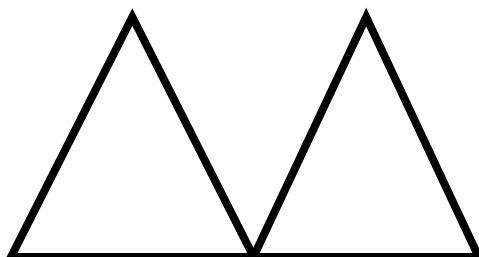
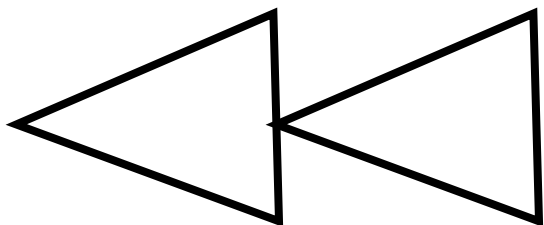
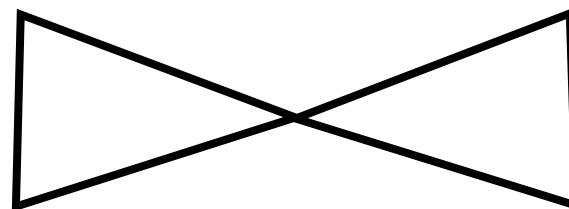
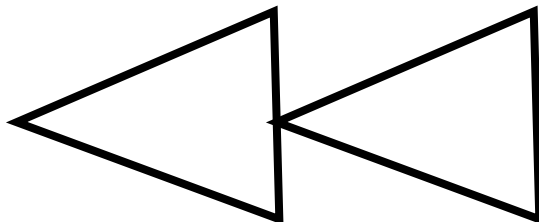
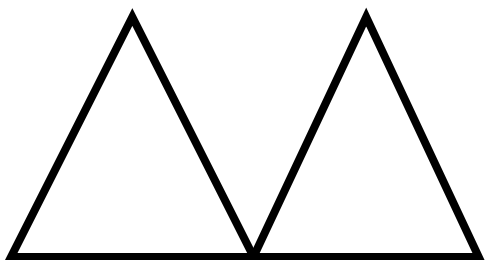

ASSOCIAZIONI DI IMMAGINI UGUALI O SIMILI

Far associare le immagini uguali o simili.

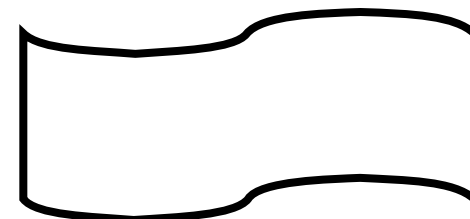
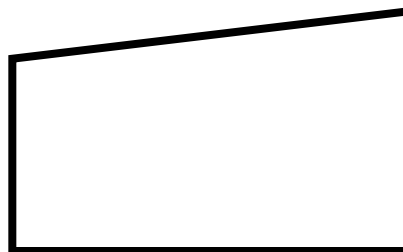
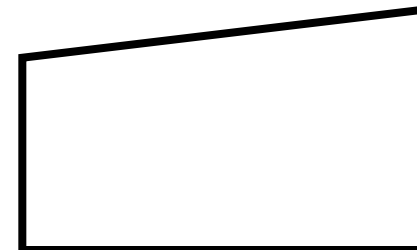
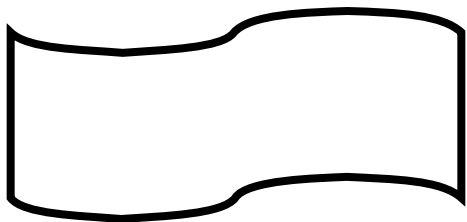

ASSOCIAZIONI DI IMMAGINI UGUALI O SIMILI

Far associare le immagini uguali o simili.

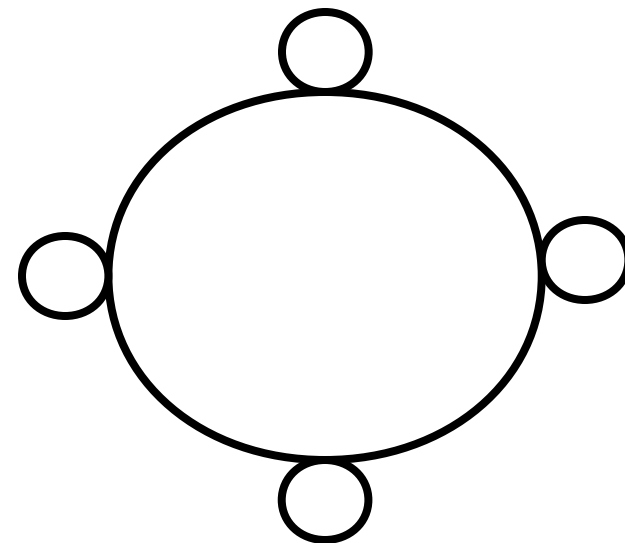
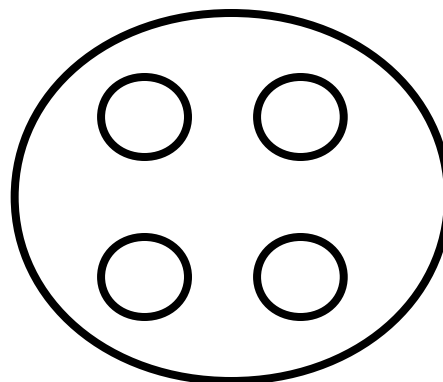
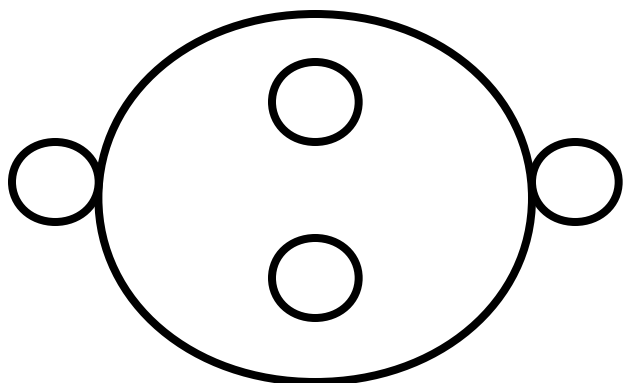
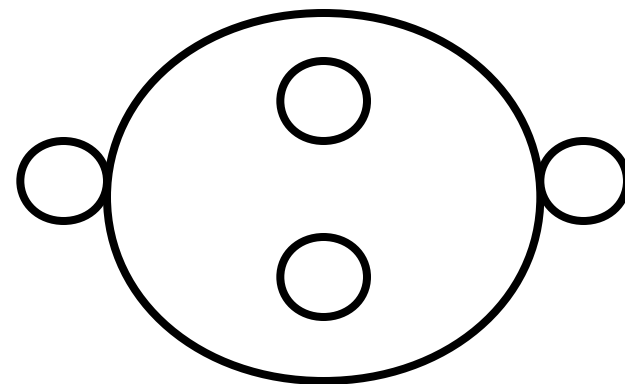
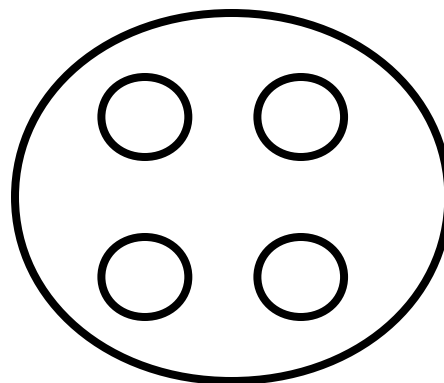
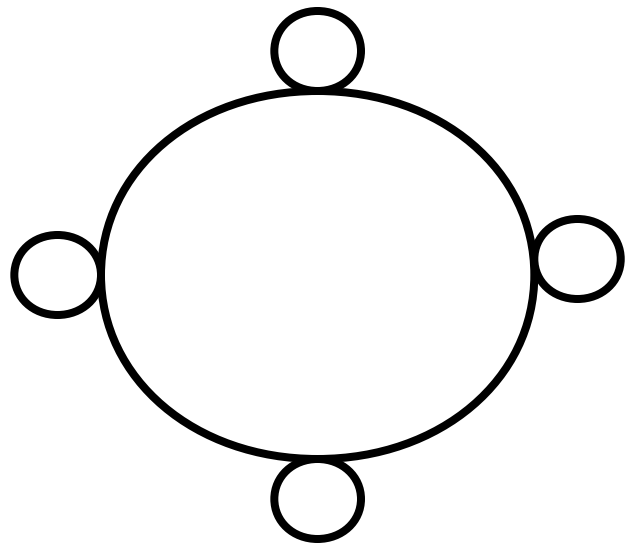

ASSOCIAZIONI DI IMMAGINI UGUALI O SIMILI

Far associare le immagini uguali o simili.

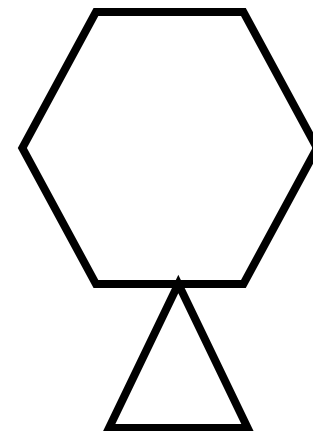
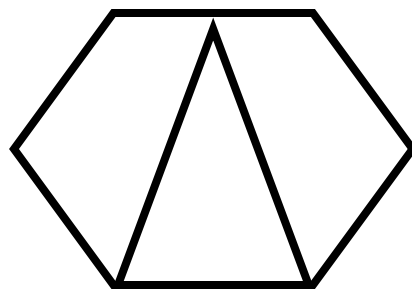
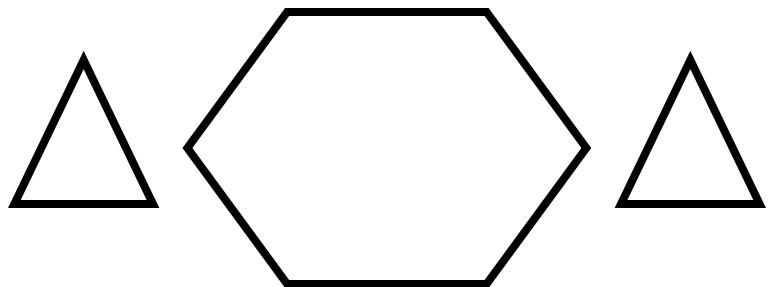
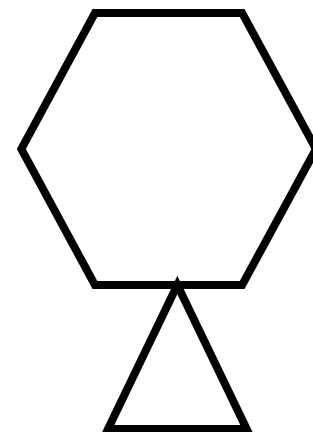
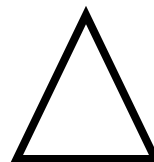
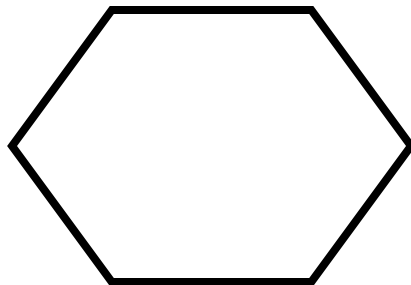
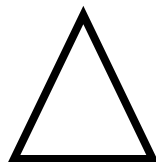
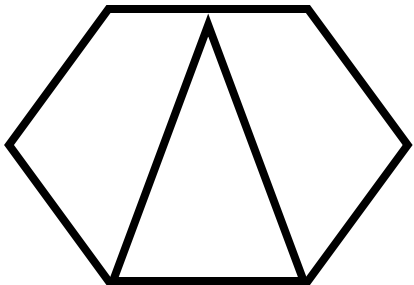

ASSOCIAZIONI DI IMMAGINI UGUALI O SIMILI

Far associare le immagini uguali o simili.

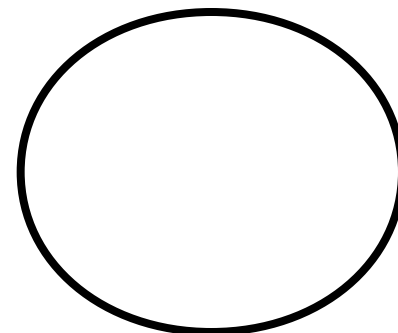
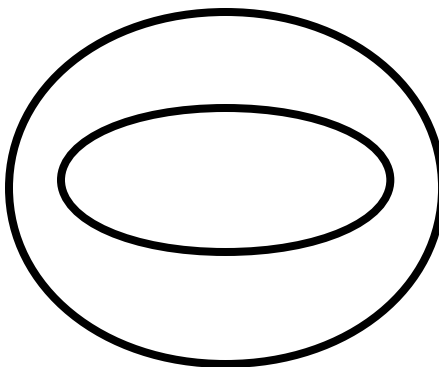
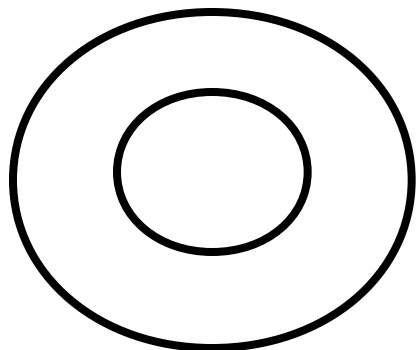
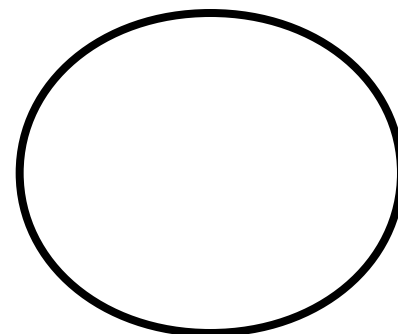
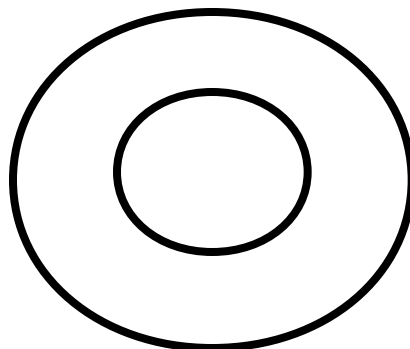
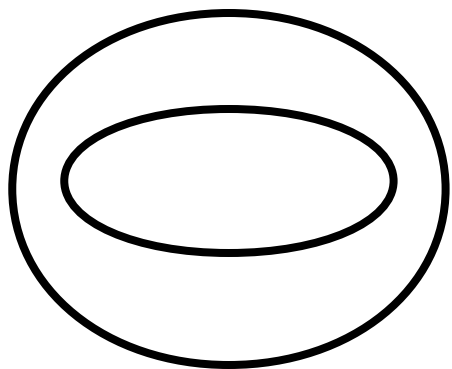

ASSOCIAZIONI DI IMMAGINI UGUALI O SIMILI

Far associare le immagini uguali o simili.

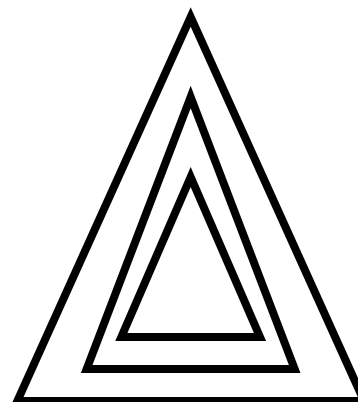
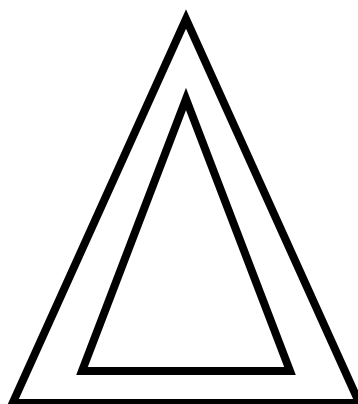
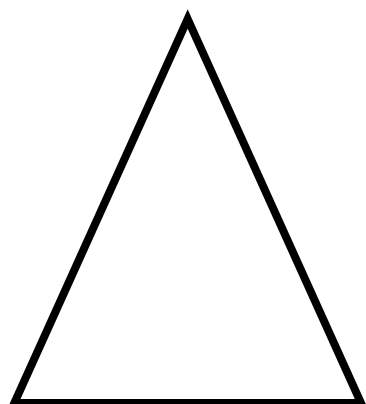
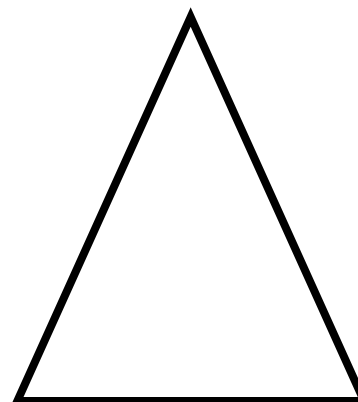
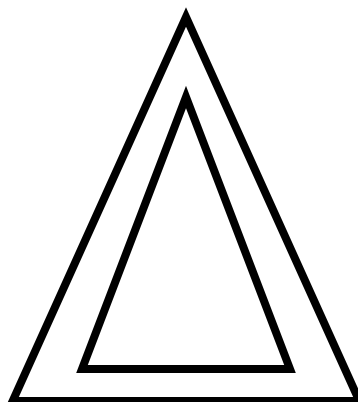
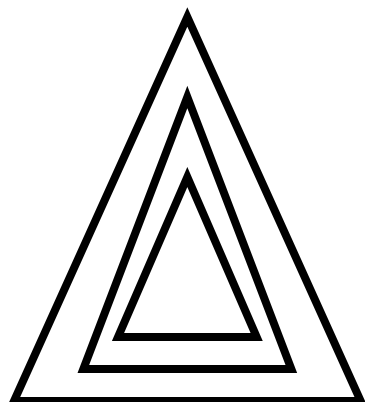

ASSOCIAZIONI DI IMMAGINI UGUALI O SIMILI

Far associare le immagini uguali o simili.

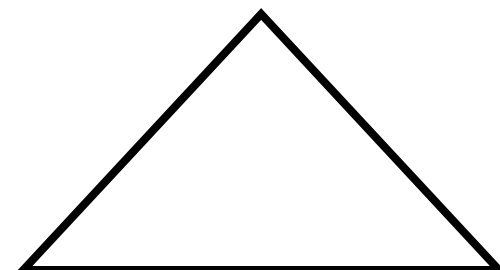
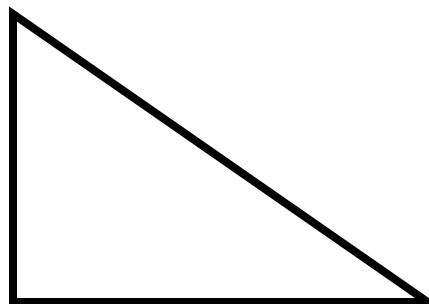
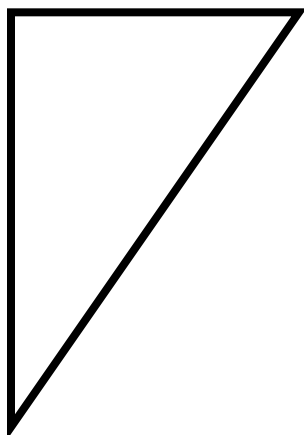
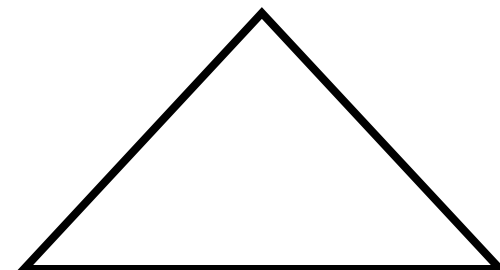
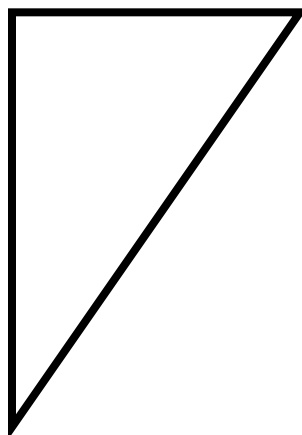
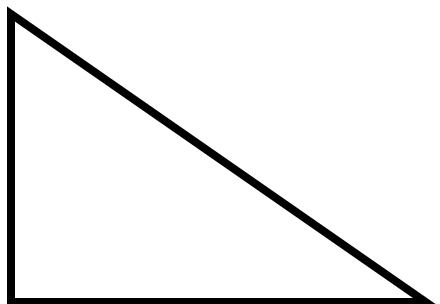

ASSOCIAZIONI DI IMMAGINI UGUALI O SIMILI

Far associare le immagini uguali o simili.



# “ VOGLIA DI CRESCERE ”

*PROGRAMMA BASE PER LO SVILUPPO LOGICO E COGNITIVO*

*ASSOCIAZIONI LOGICHE*

## **ASSOCIAZIONI LOGICHE**

L'attività di associare un oggetto, un animale, un vegetale o una forma geometrica ad un altro, ricercando un possibile legame logico di uso, funzione, forma, posizione nello spazio, somiglianza, causa - effetto, parte - tutto ecc. implica la stimolazione di processi di astrazione, classificazione ed organizzazione spaziale, basilari per lo sviluppo intellettuale.

### **UTILIZZAZIONE**

Per utilizzare tali schede basta indicare al bambino l'immagine presente nella parte alta della scheda, chiedendo di associarla con un'altra disegnata nella parte bassa. Nei bambini sordi, si cercherà di utilizzare il segno mimico che significa legame. Dopo che il bambino avrà effettuato l'associazione l'educatore chiarirà il motivo che lo ha spinto ad effettuare tale scelta.

### **VERBALIZZAZIONE**

1<sup>a</sup> Fase

Inizialmente per questa attività chiederemo al bambino solo il nome degli oggetti che si associano.

2<sup>a</sup> Fase.

In un secondo momento, sarà il bambino stesso ad esplicitare il motivo che lo ha spinto ad effettuare quell'associazione.

### **ETA' DI RIFERIMENTO**

Cinque anni nello sviluppo logico.

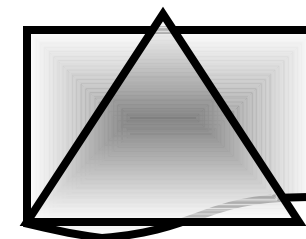
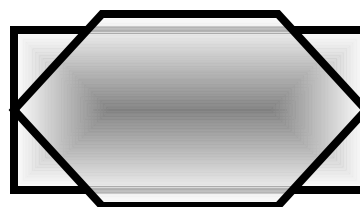
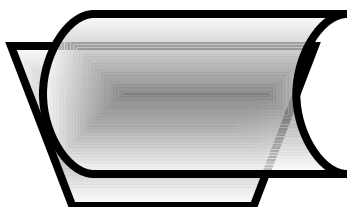
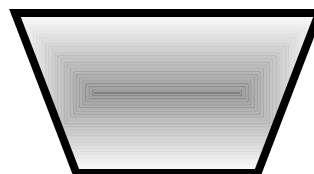
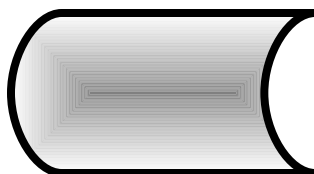
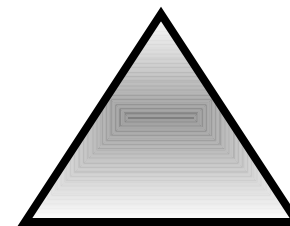
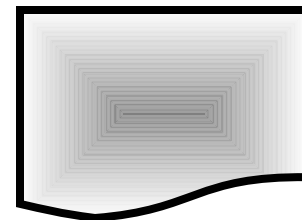
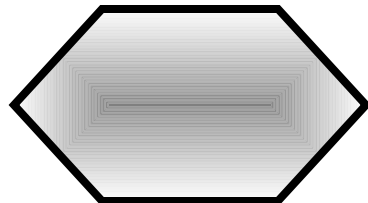
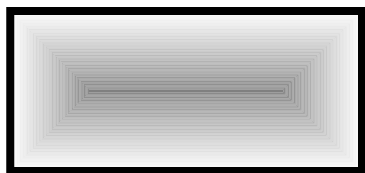

### ASSOCIAZIONI LOGICHE

Far associare secondo un legame logico.

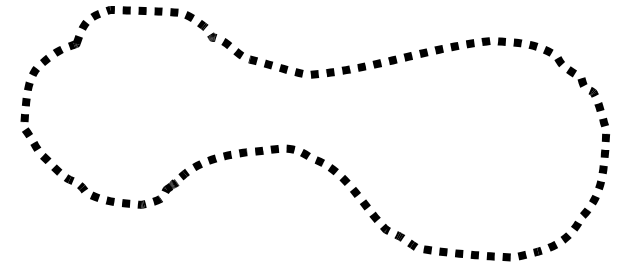
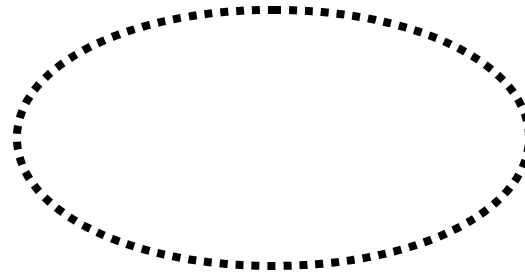
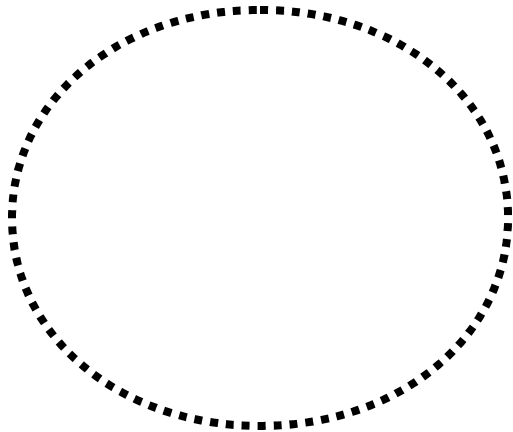
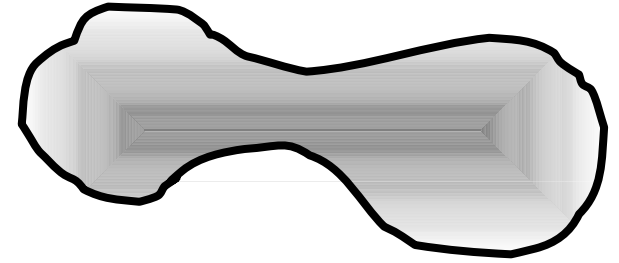
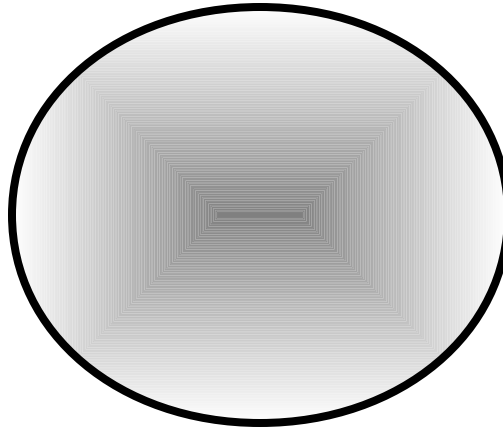
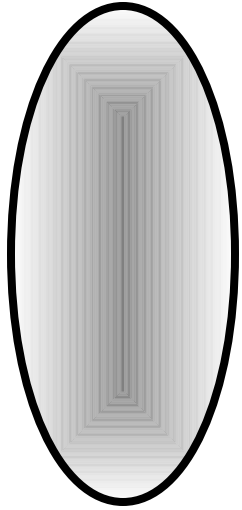

## ASSOCIAZIONI LOGICHE

Far associare secondo un legame logico.

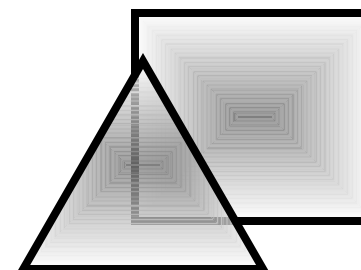
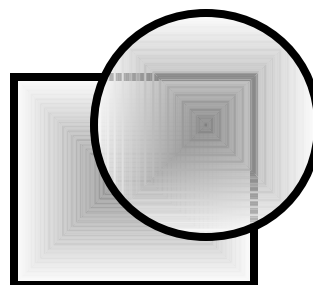
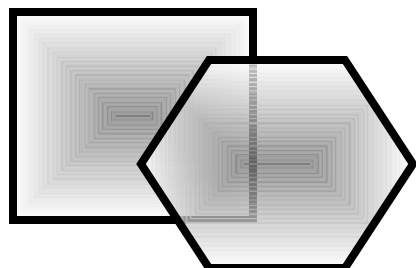
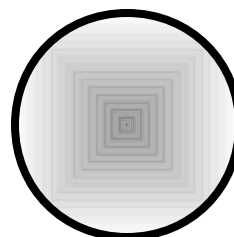
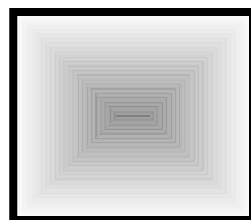
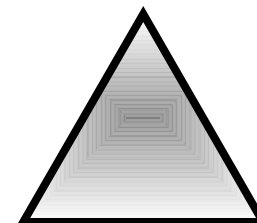
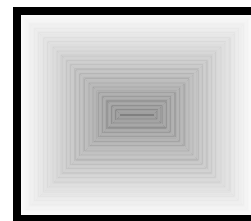
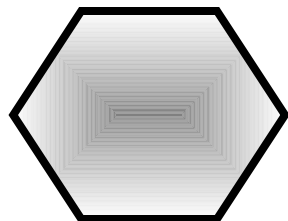
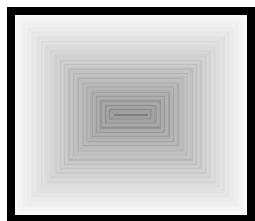

## ASSOCIAZIONI LOGICHE

Far associare secondo un legame logico.

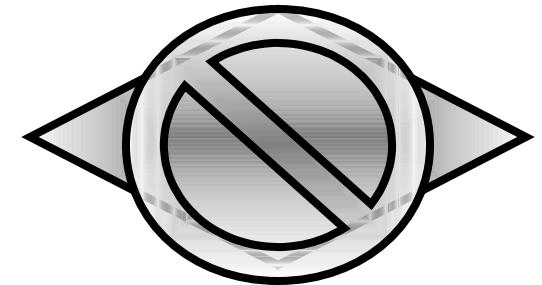
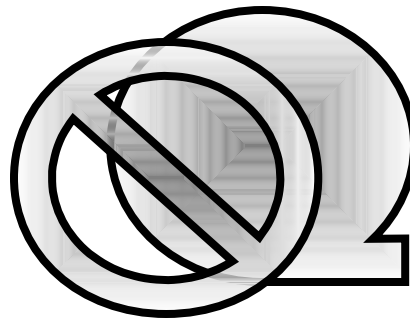
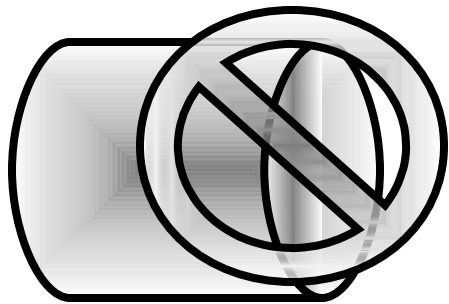
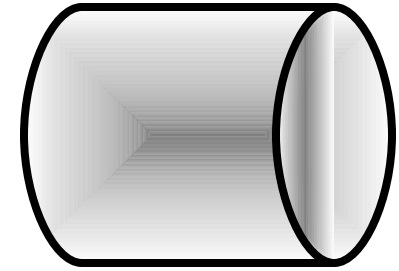
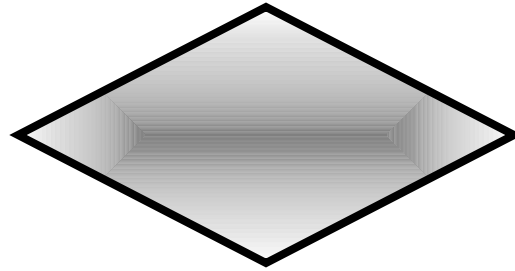
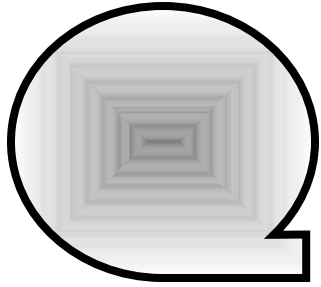

### ASSOCIAZIONI LOGICHE

Far associare secondo un legame logico.

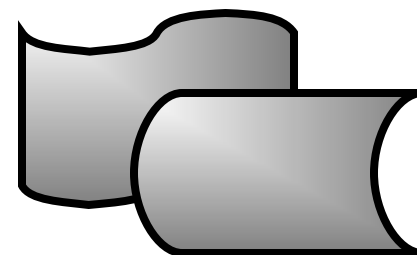
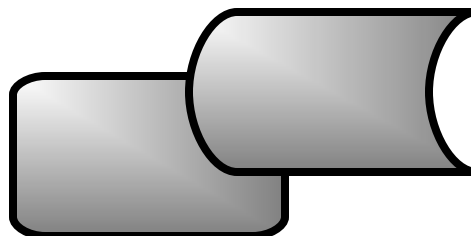
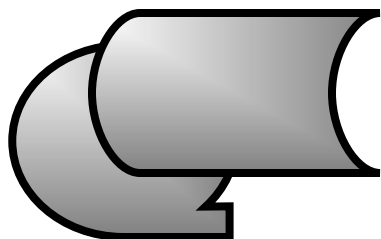
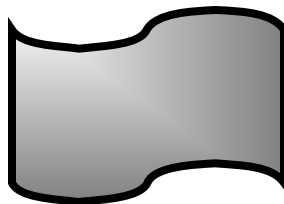
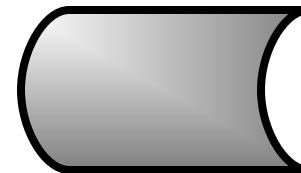
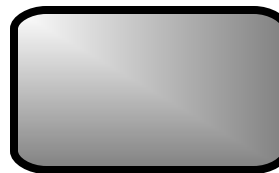
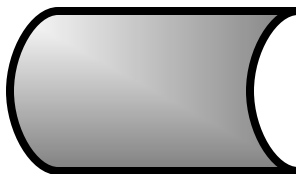
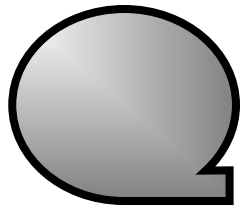

## ASSOCIAZIONI LOGICHE

Far associare secondo un legame logico.

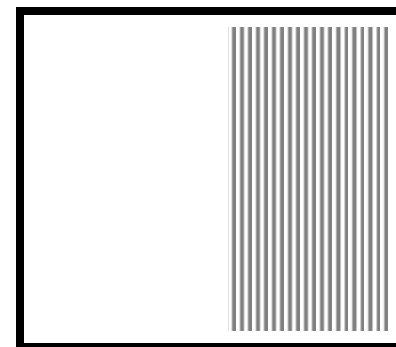
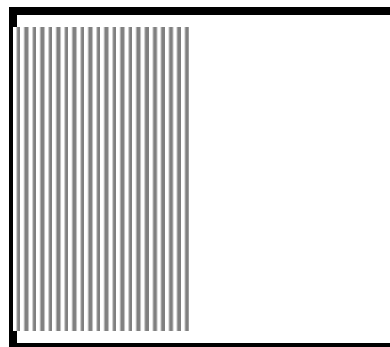
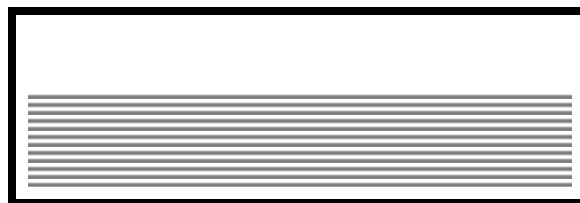
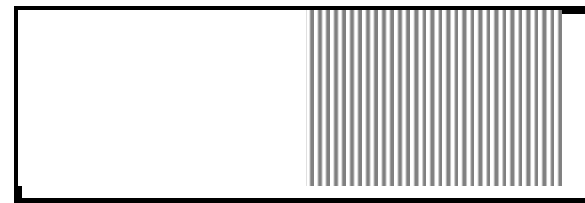
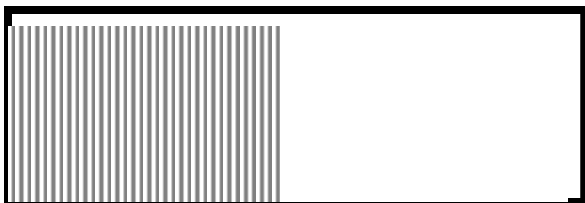

## ASSOCIAZIONI LOGICHE

Far associare secondo un legame logico.



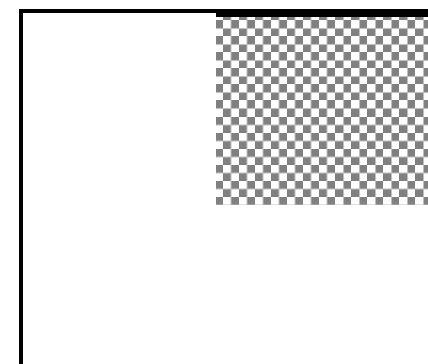
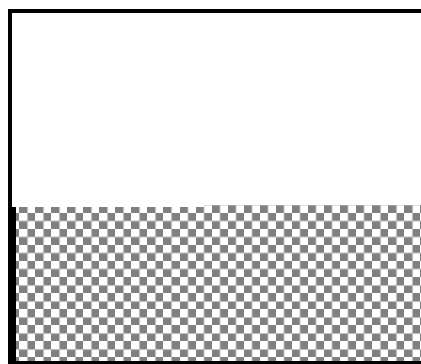
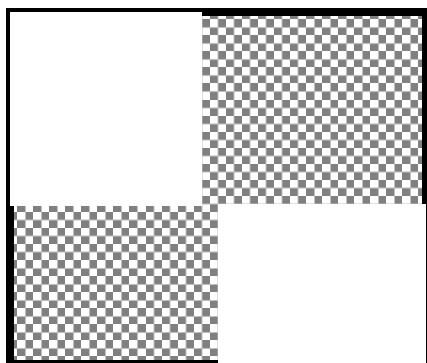
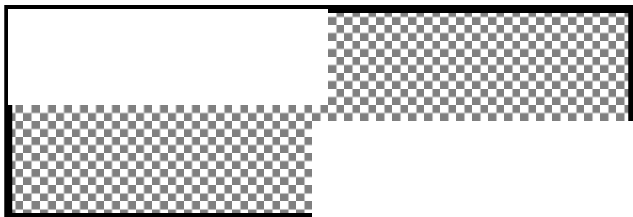

## ASSOCIAZIONI LOGICHE

Far associare le immagini secondo un legame logico.

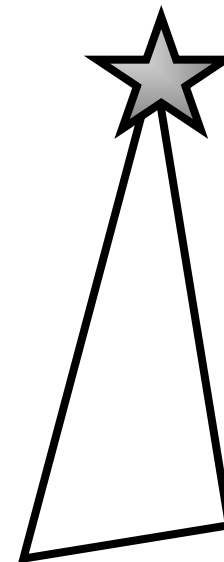
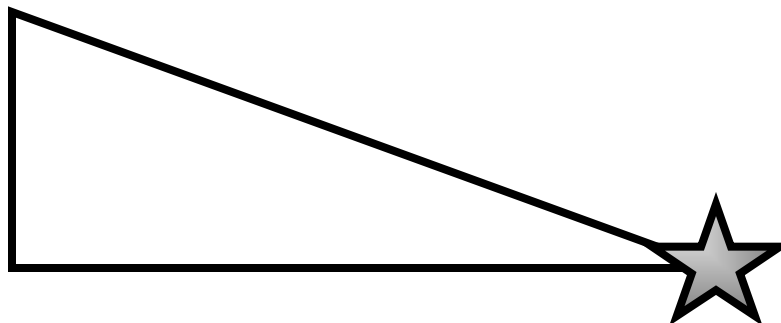
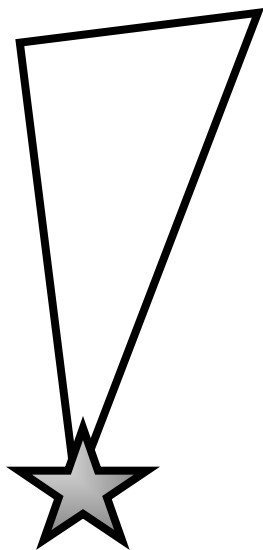
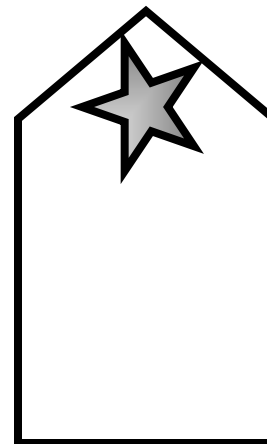
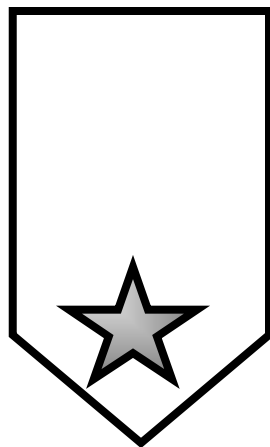
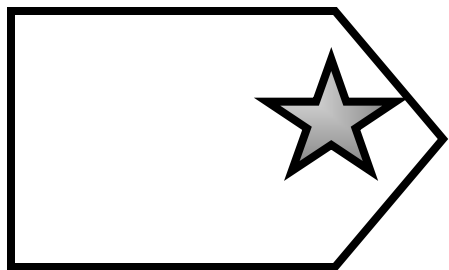

### ASSOCIAZIONI LOGICHE

Far associare le immagini secondo un legame logico.

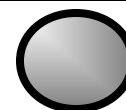
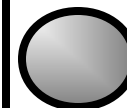
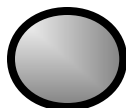
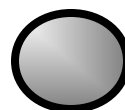
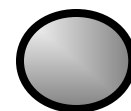
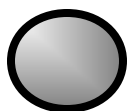

## ASSOCIAZIONI LOGICHE

Far associare le immagini secondo un legame logico.

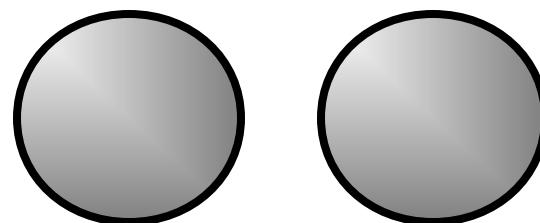
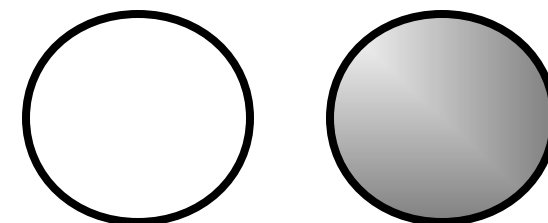
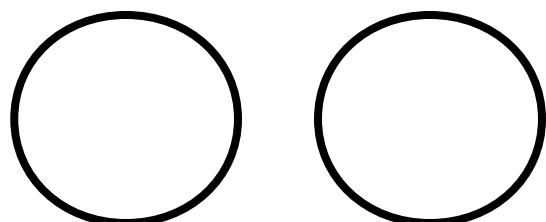
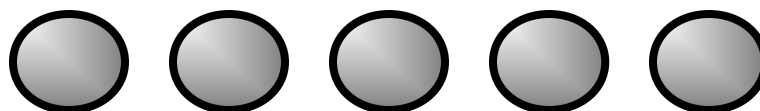
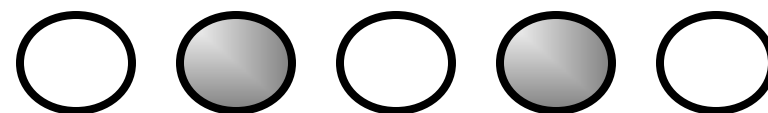
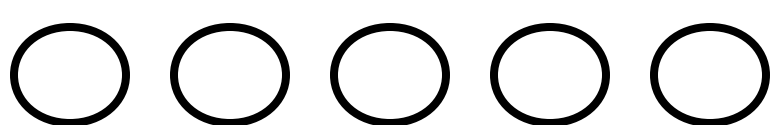

### ASSOCIAZIONI LOGICHE

Far associare le immagini secondo un legame logico.

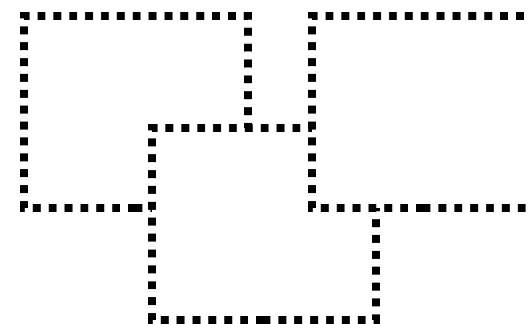
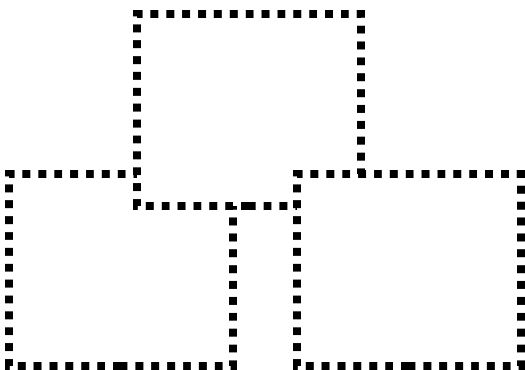
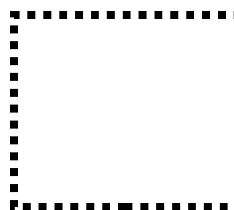
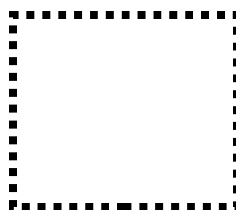
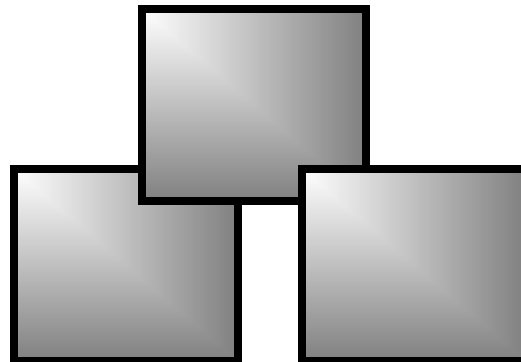
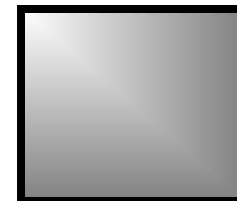
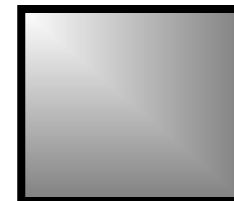
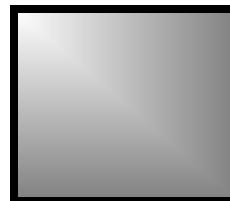
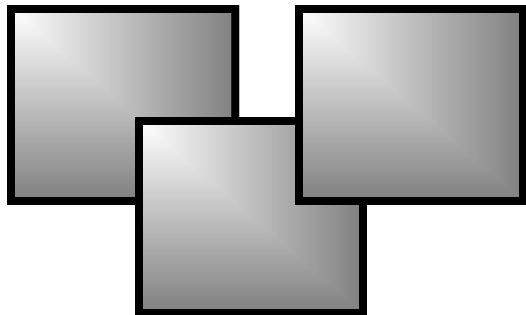

## ASSOCIAZIONI LOGICHE

Far associare le immagini secondo un legame logico.

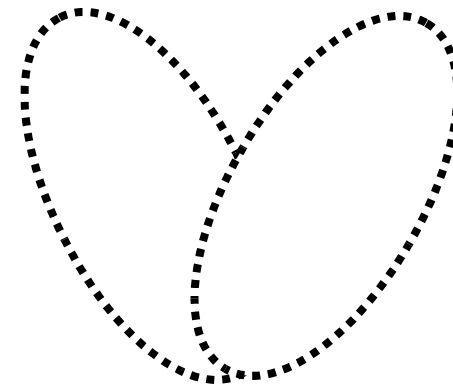
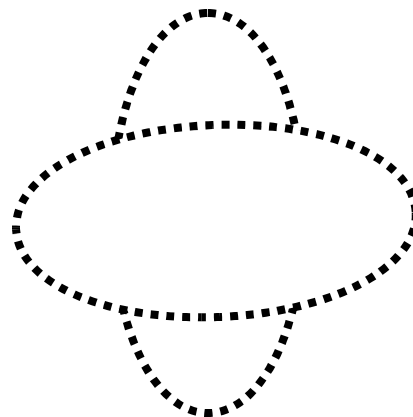
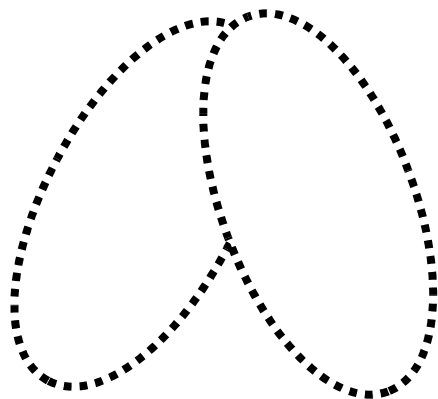
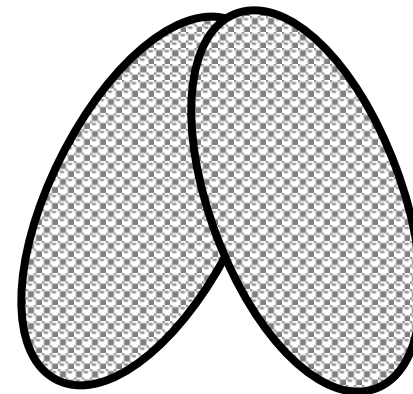
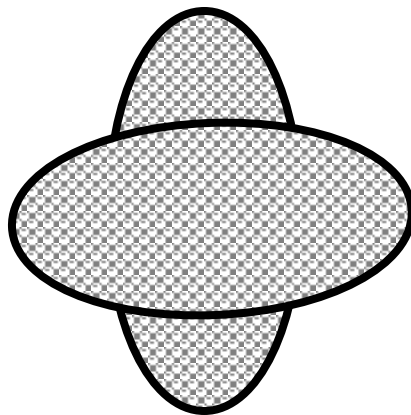
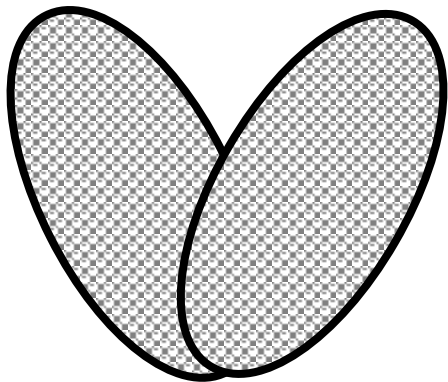

## ASSOCIAZIONI LOGICHE

Far associare le immagini secondo un legame logico.

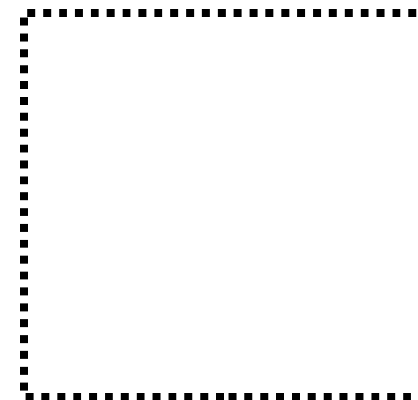
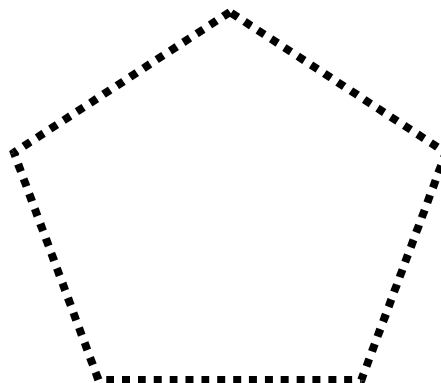
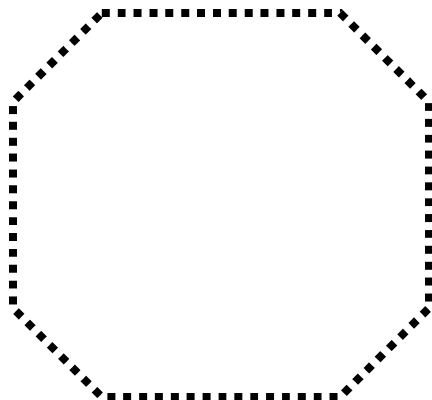
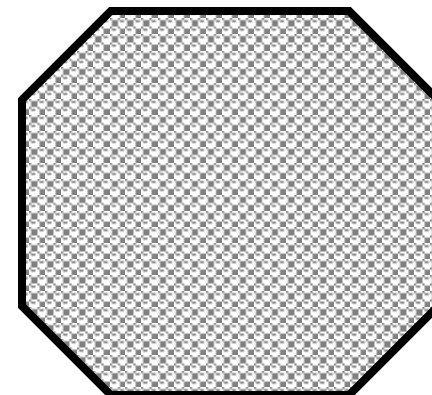
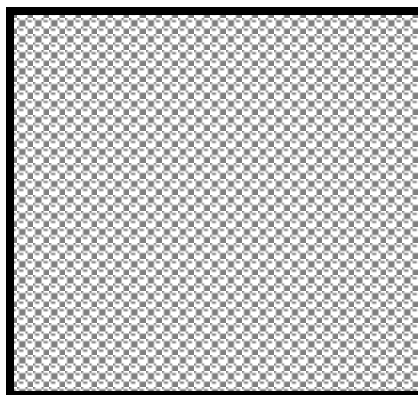
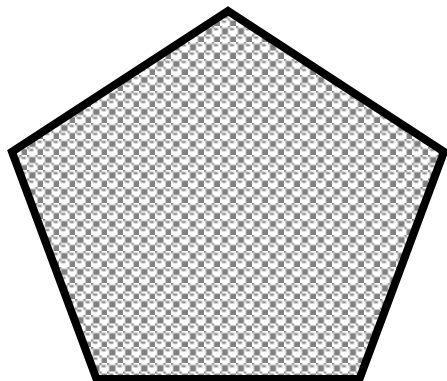

### ASSOCIAZIONI LOGICHE

Far associare le immagini secondo un legame logico.

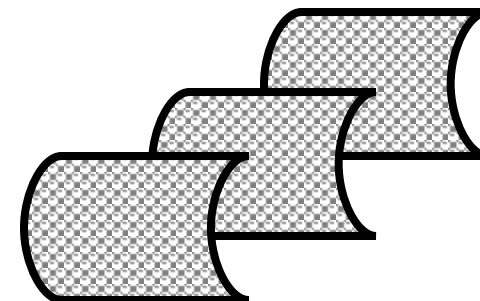
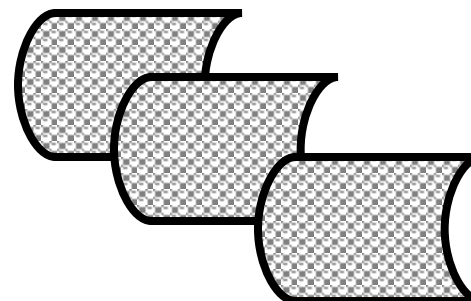
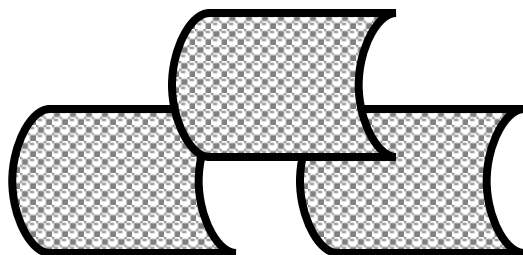
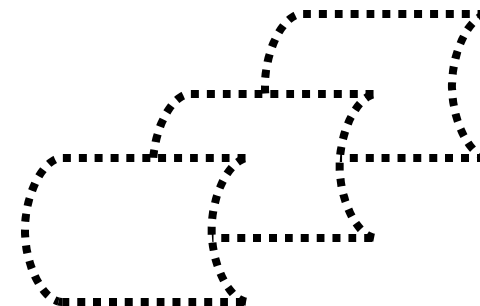
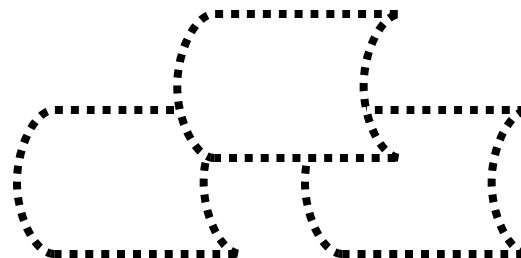
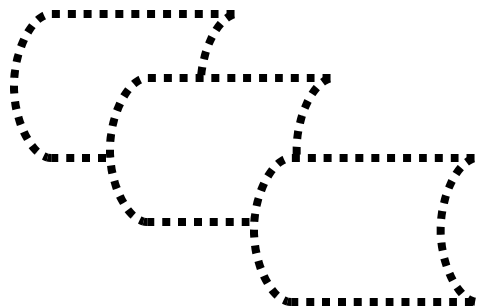

### ASSOCIAZIONI LOGICHE

Far associare le immagini secondo un legame logico.



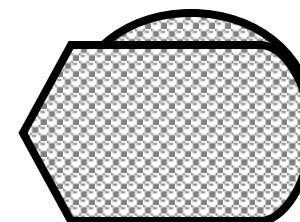
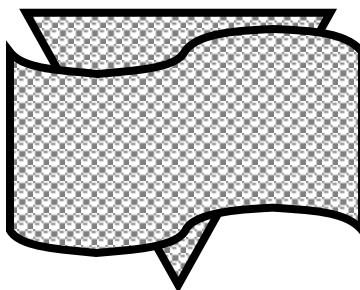
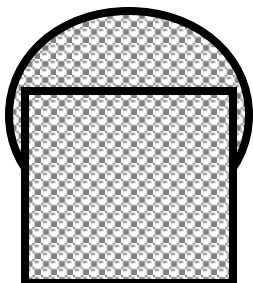
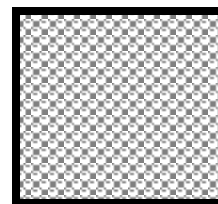
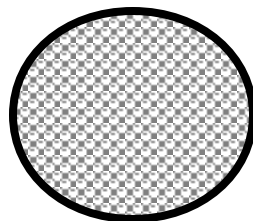
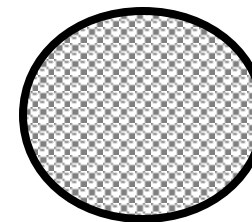
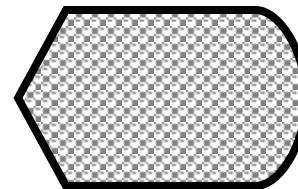
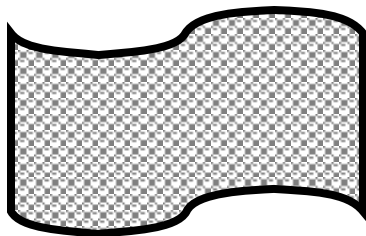
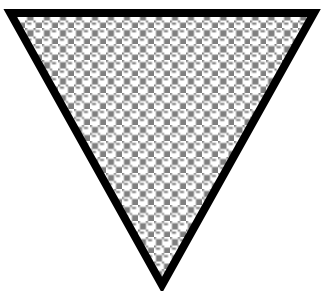

### ASSOCIAZIONI LOGICHE

Far associare le immagini secondo un legame logico.

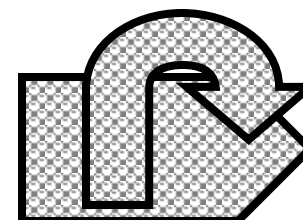
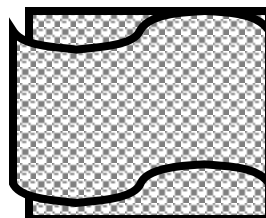
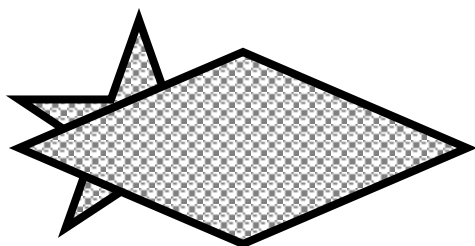
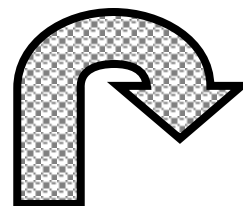
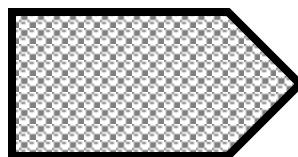
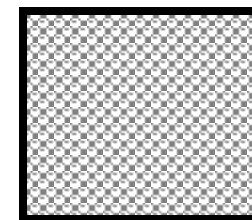
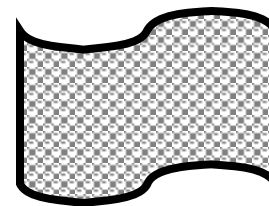
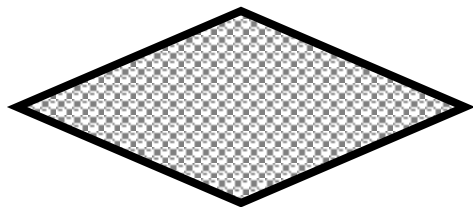
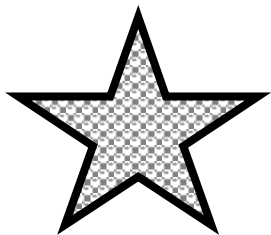

## ASSOCIAZIONI LOGICHE

Far associare le immagini secondo un legame logico.

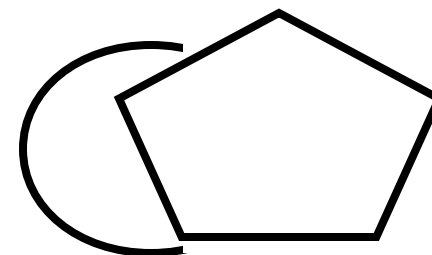
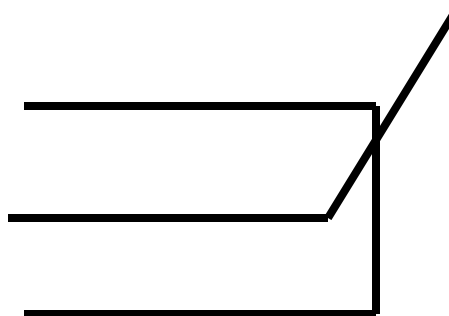
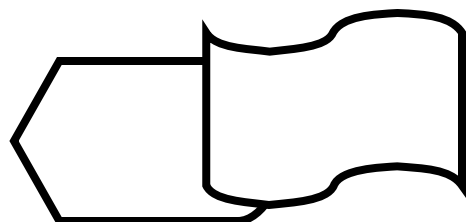
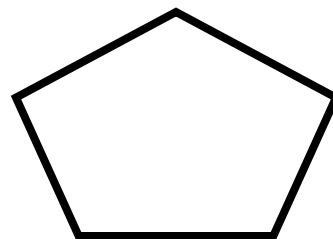
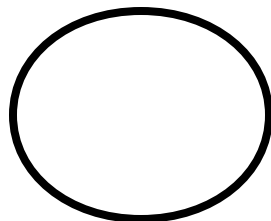
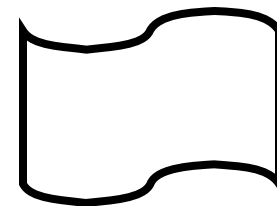
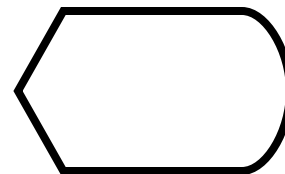
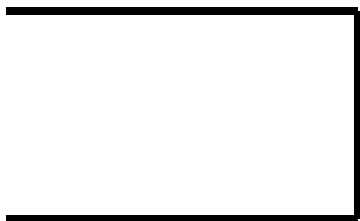

## ASSOCIAZIONI LOGICHE

Far associare le immagini secondo un legame logico.

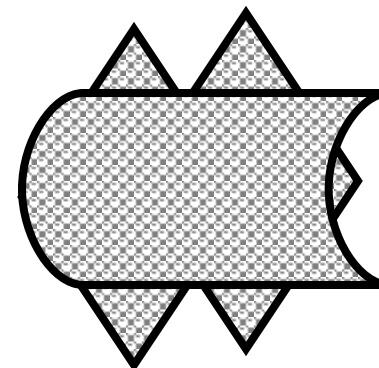
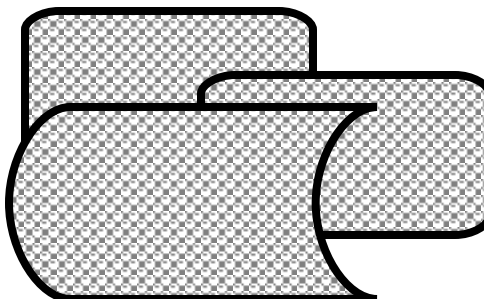
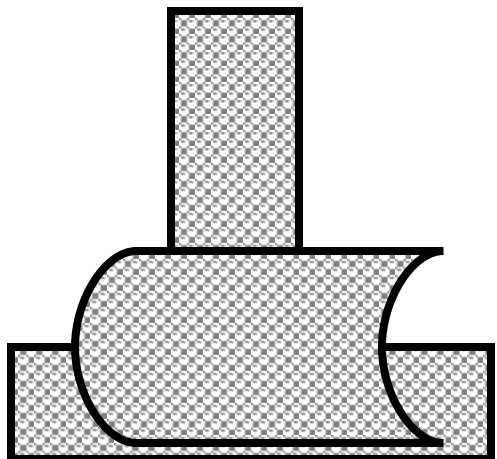
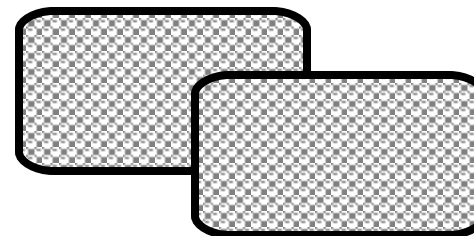
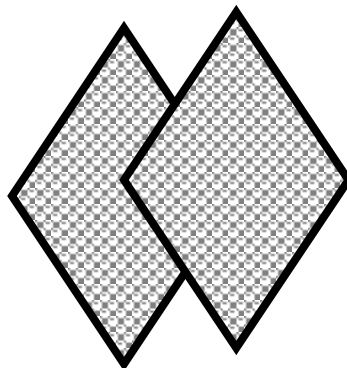
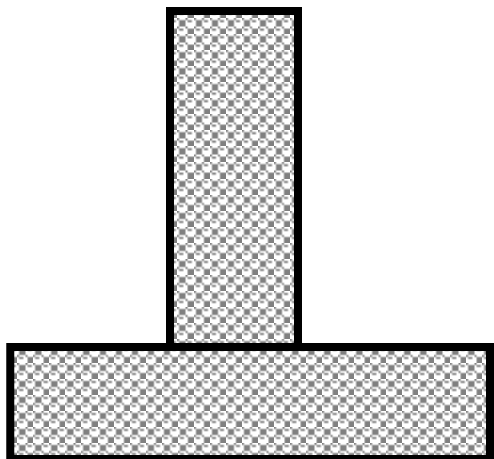

## ASSOCIAZIONI LOGICHE

Far associare le immagini secondo un legame logico.

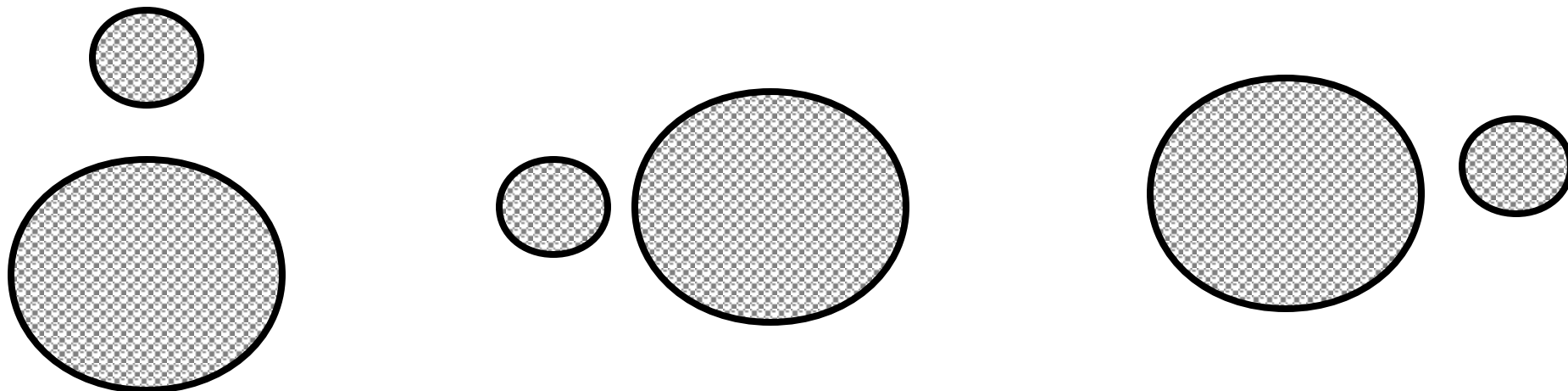
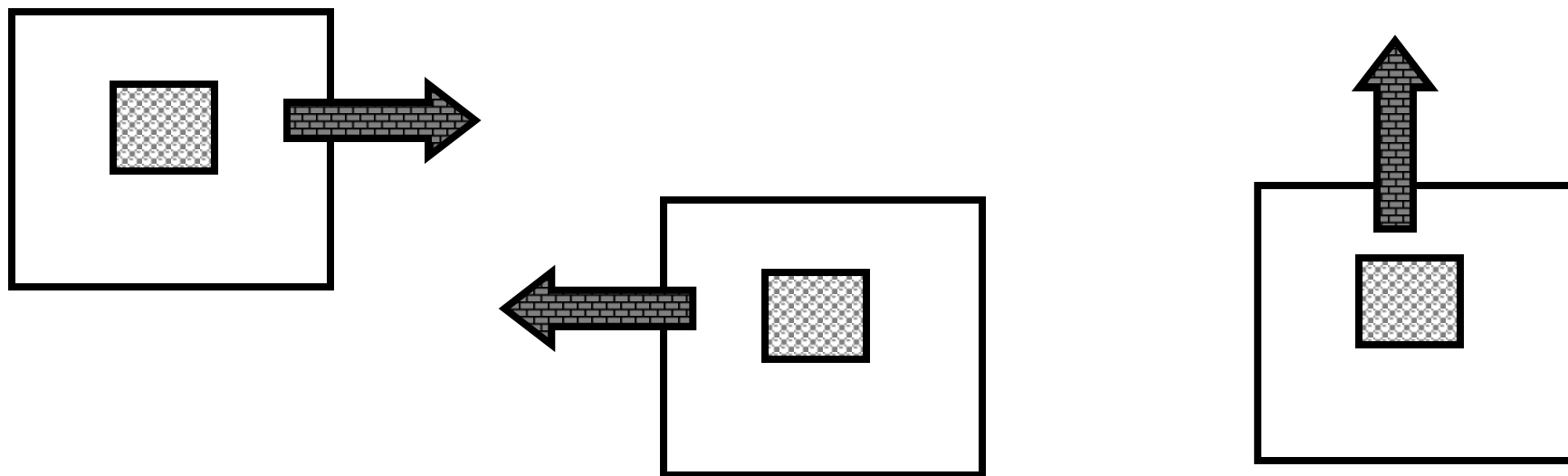

### ASSOCIAZIONI LOGICHE

Far associare le immagini secondo un legame logico.

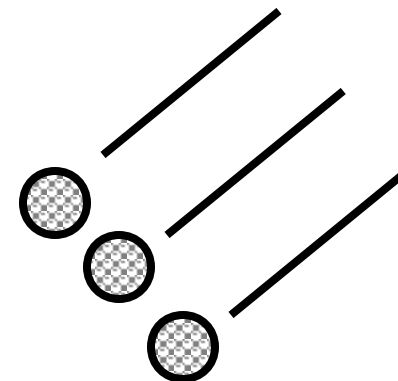
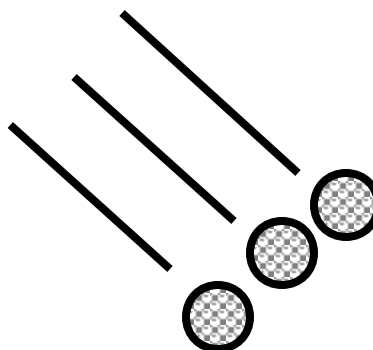
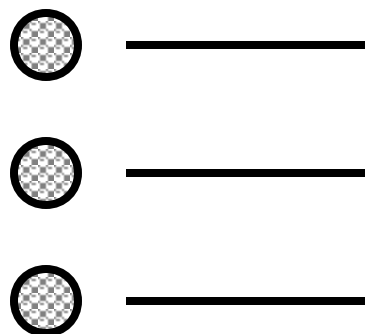
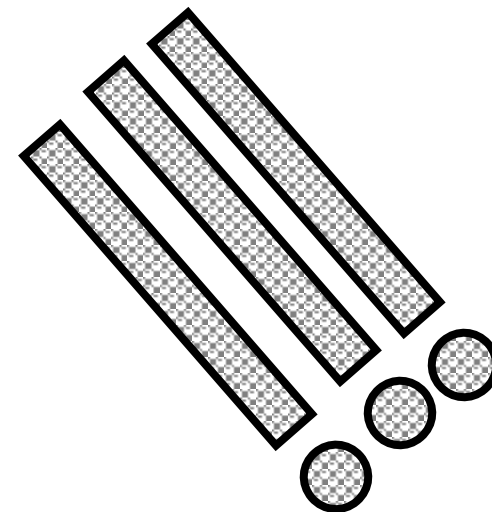
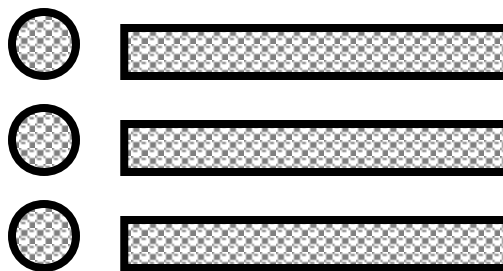
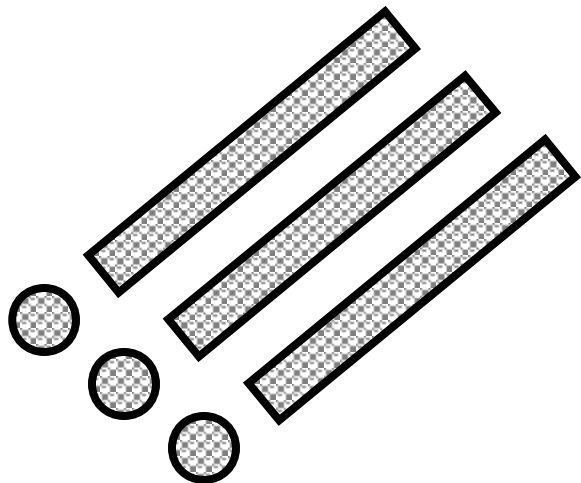

### ASSOCIAZIONI LOGICHE

Far associare le immagini secondo un legame logico.

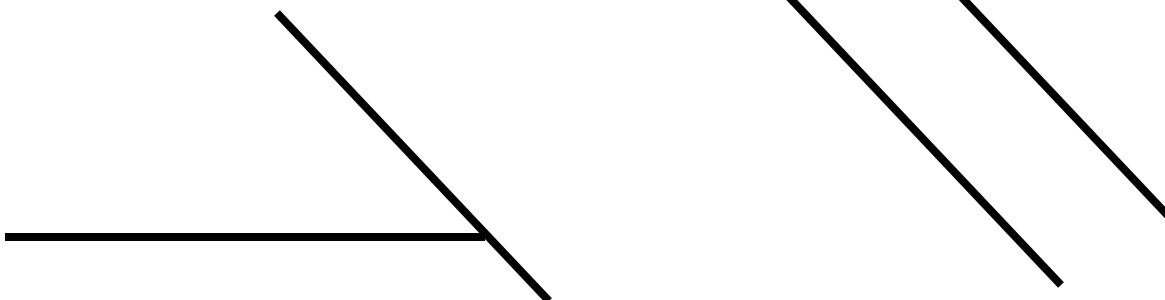
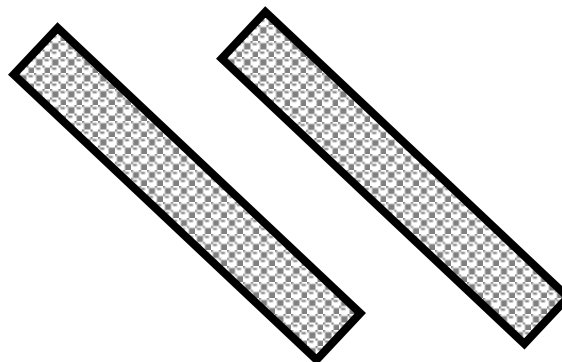
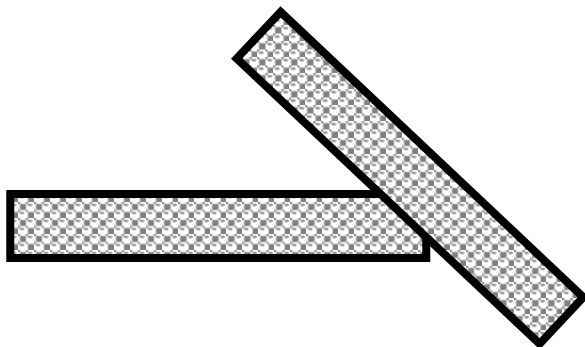

## ASSOCIAZIONI LOGICHE

Far associare le immagini secondo un legame logico.

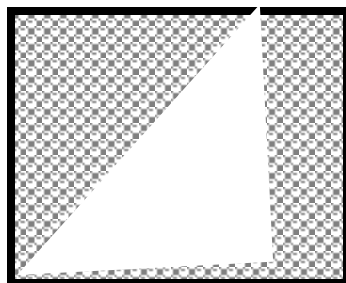
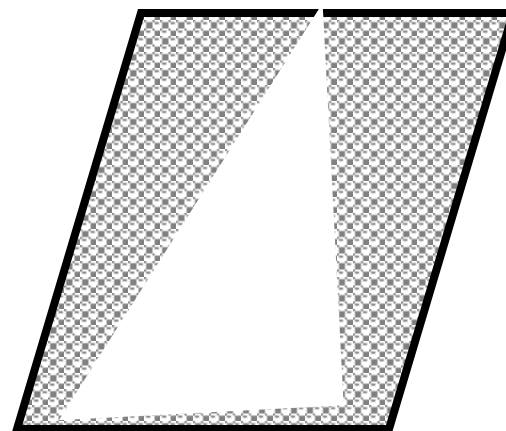
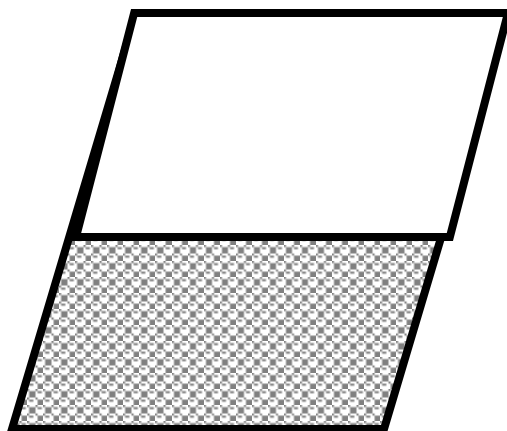
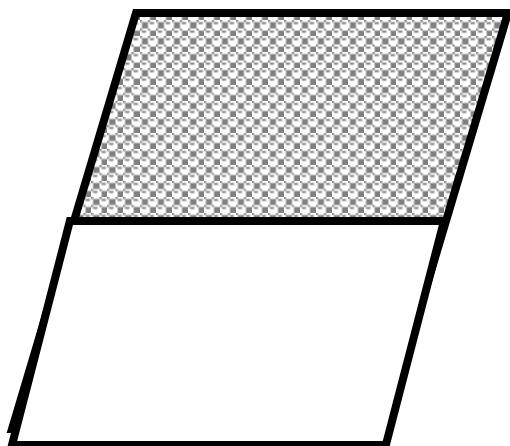

## ASSOCIAZIONI LOGICHE

Far associare le immagini secondo un legame logico.



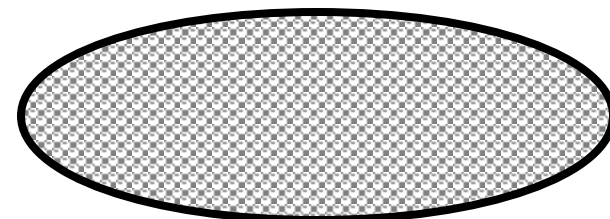
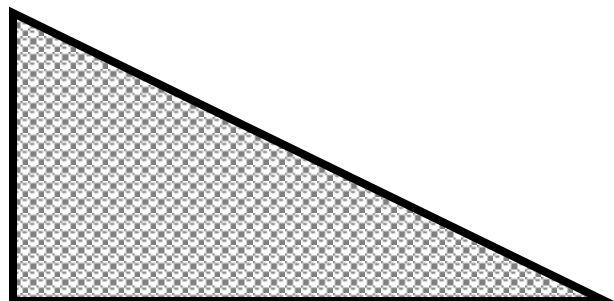
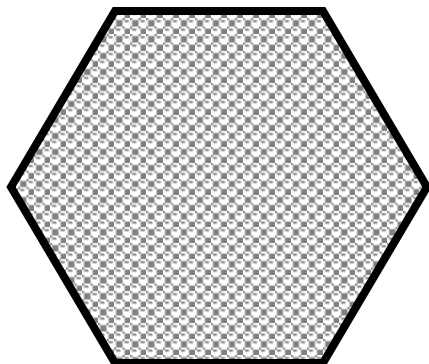

## ASSOCIAZIONI LOGICHE

Far associare le immagini secondo un legame logico.

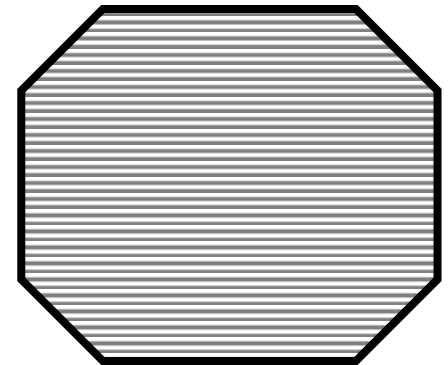
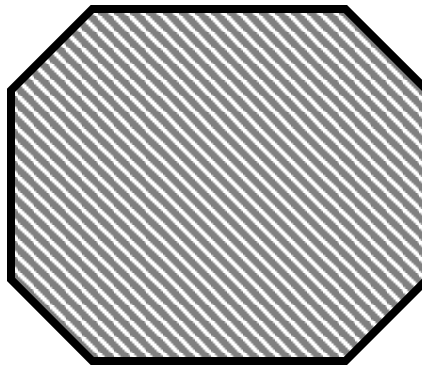
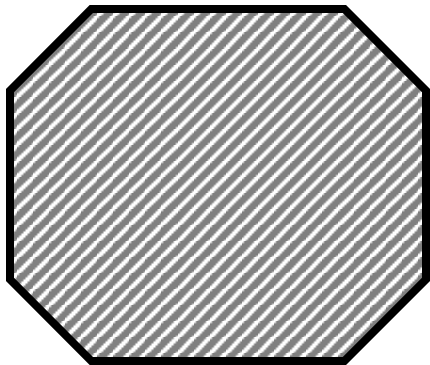
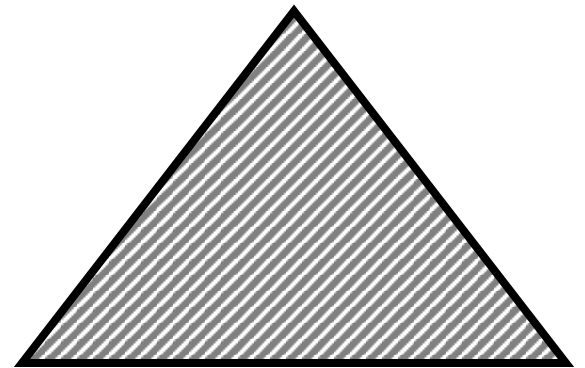
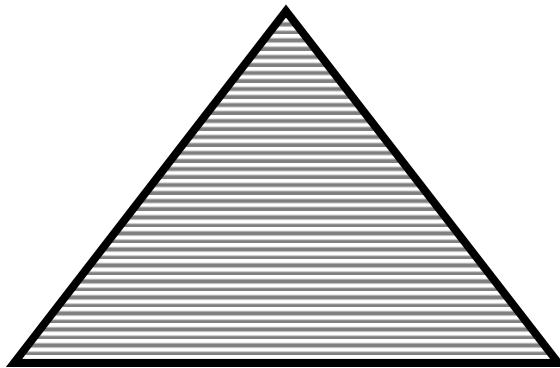
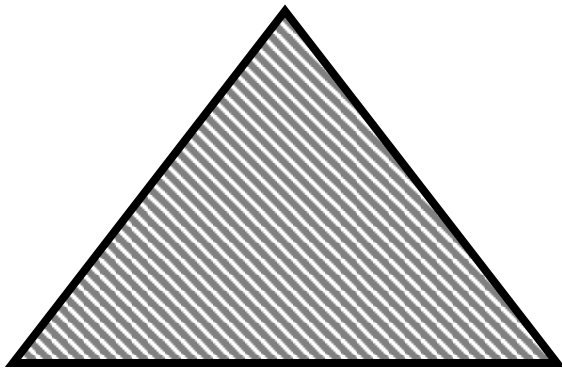

### ASSOCIAZIONI LOGICHE

Far associare le immagini secondo un legame logico.

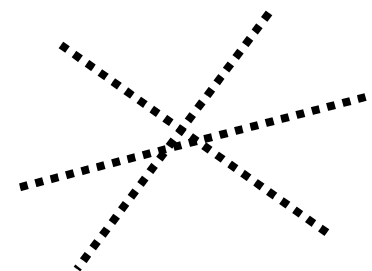
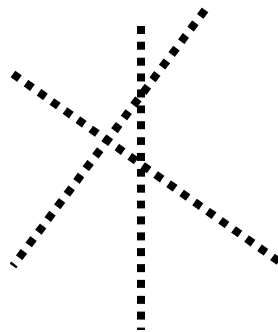
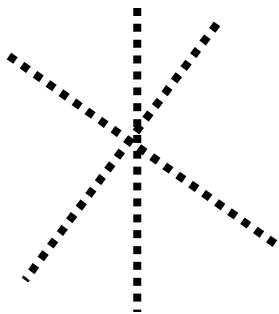
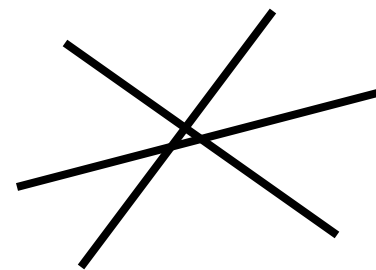
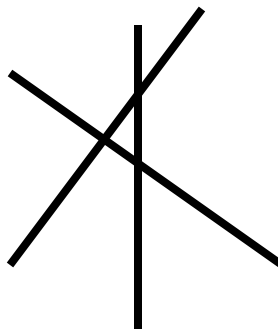
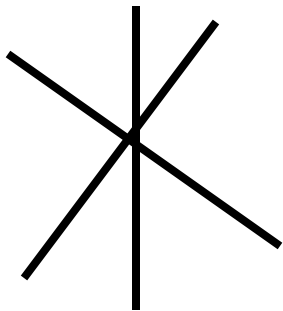

### ASSOCIAZIONI LOGICHE

Far associare le immagini secondo un legame logico.

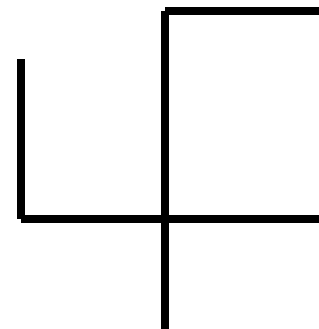
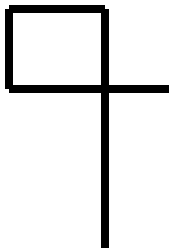
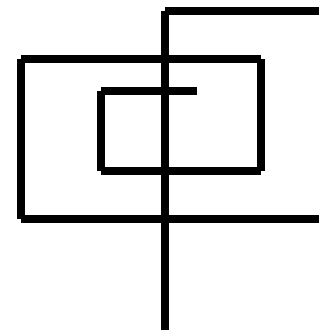
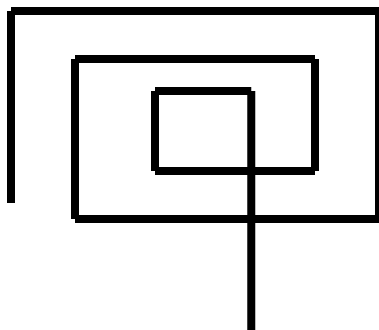
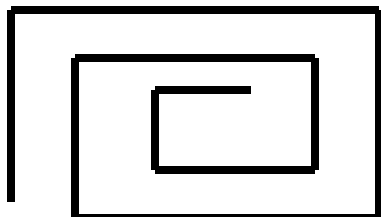

### ASSOCIAZIONI LOGICHE

Far associare le immagini secondo un legame logico.

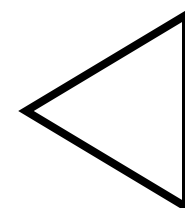
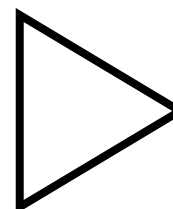
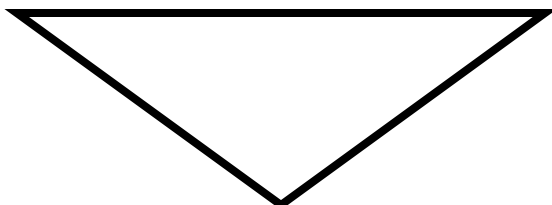
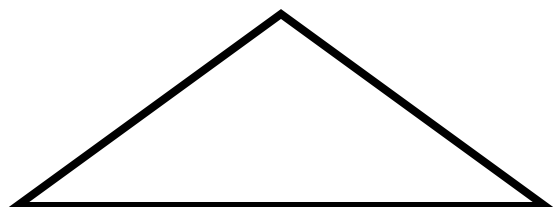
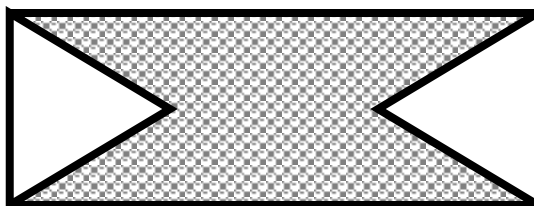
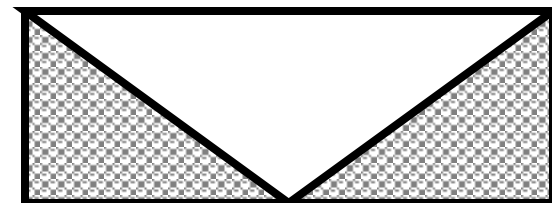
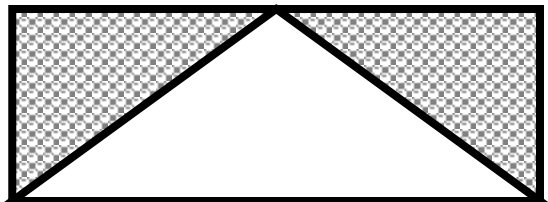

## ASSOCIAZIONI LOGICHE

Far associare le immagini secondo un legame logico.

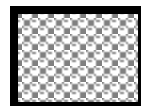
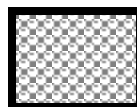
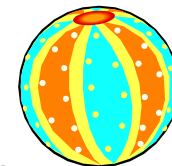
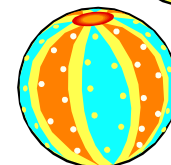
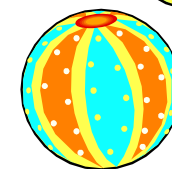

## ASSOCIAZIONI LOGICHE

Far associare le immagini secondo un legame logico.

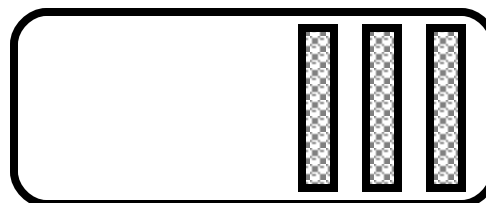
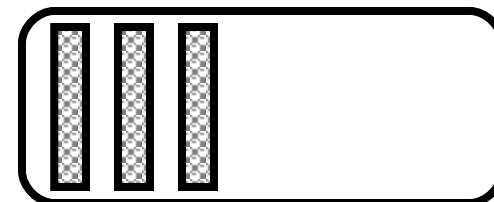
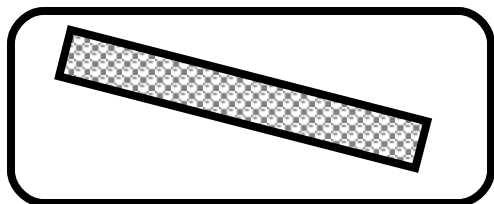
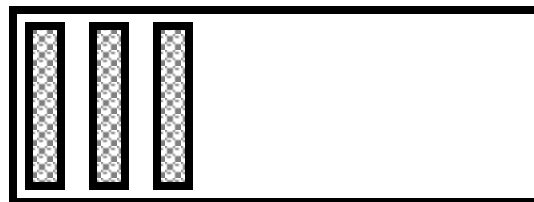
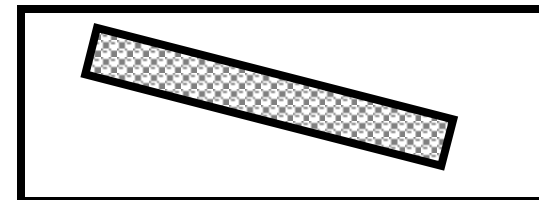
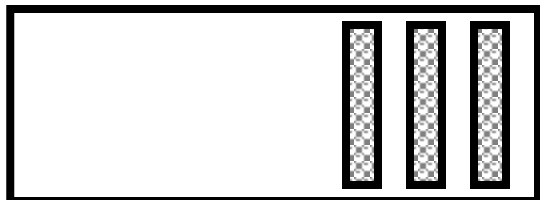

## ASSOCIAZIONI LOGICHE

Far associare le immagini secondo un legame logico.

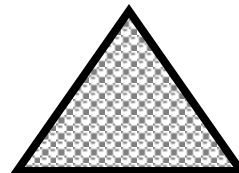
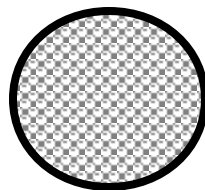
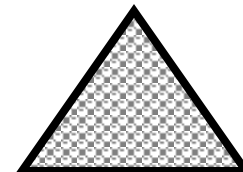
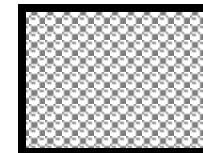
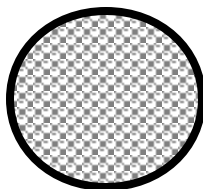
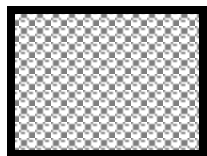
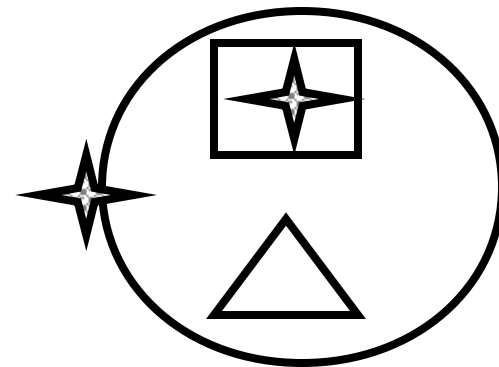
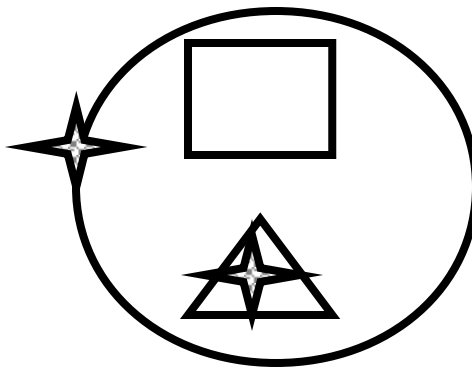
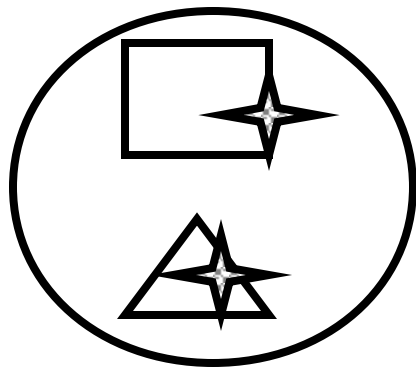

### ASSOCIAZIONI LOGICHE

Far associare le immagini secondo un legame logico.



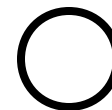
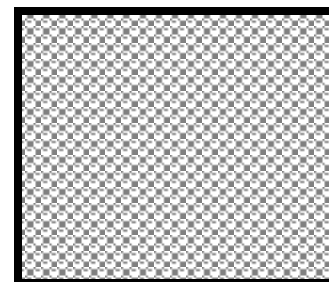
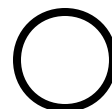
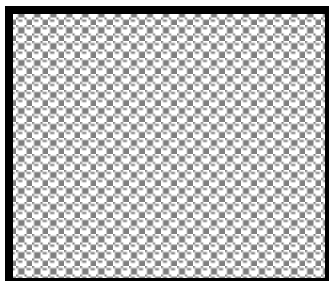
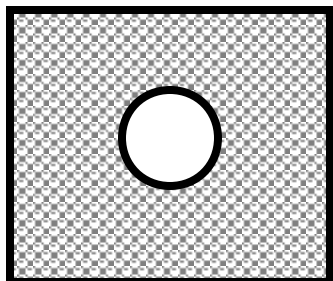
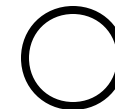
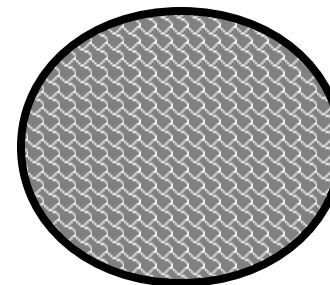
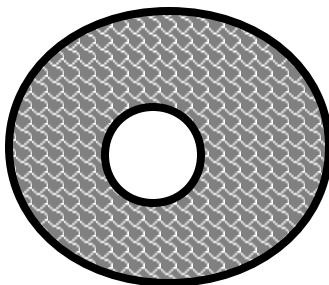
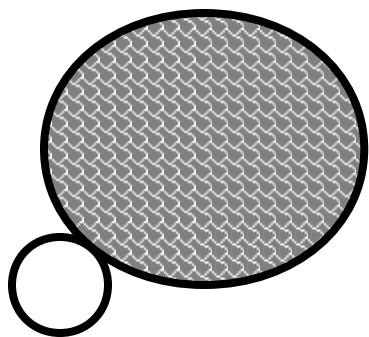

## ASSOCIAZIONI LOGICHE

Far associare le immagini secondo un legame logico.

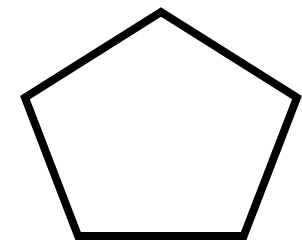
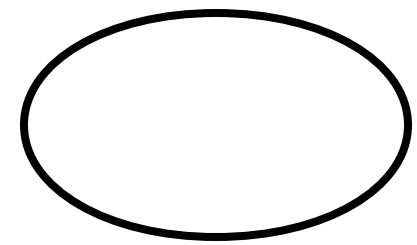
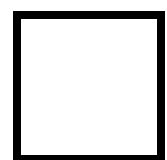
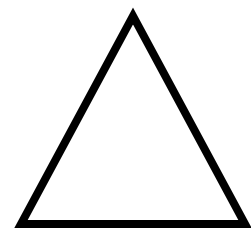
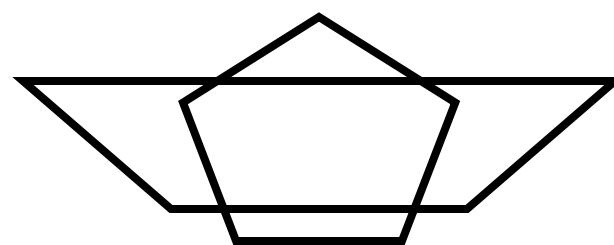
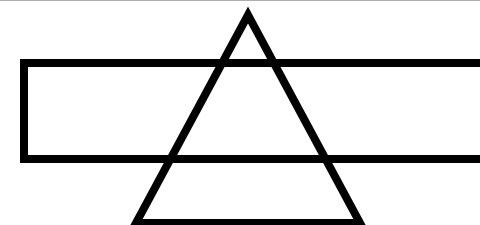
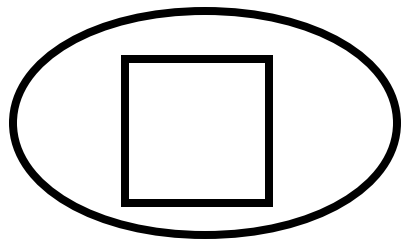

### ASSOCIAZIONI LOGICHE

Far associare le immagini secondo un legame logico.

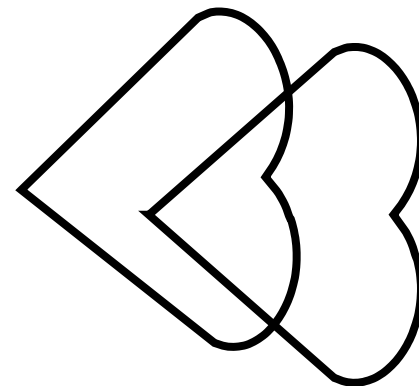
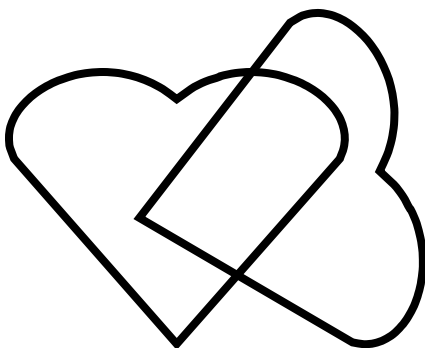
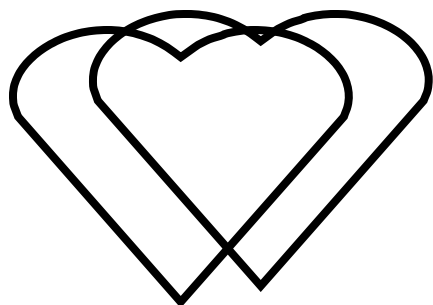
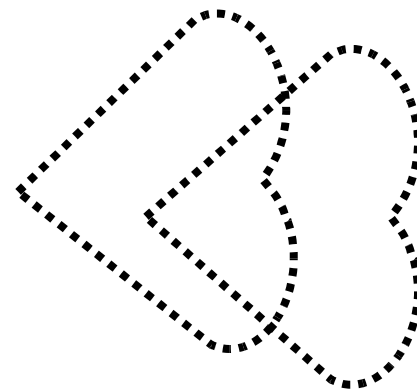
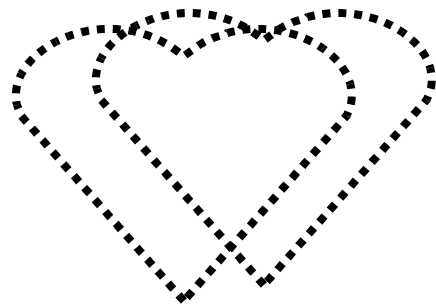
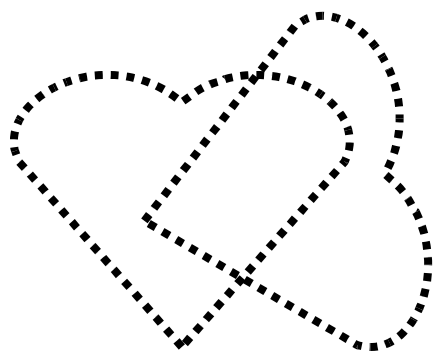

### ASSOCIAZIONI LOGICHE

Far associare le immagini secondo un legame logico.

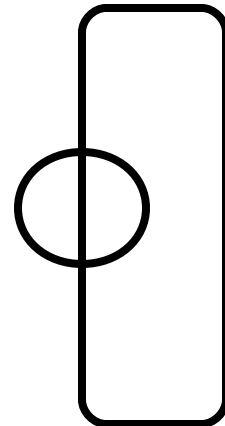
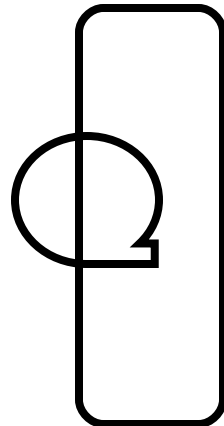
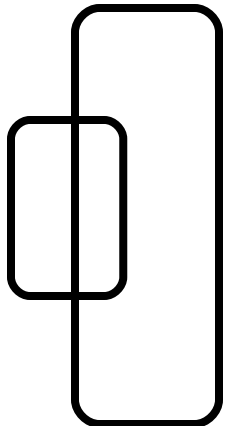
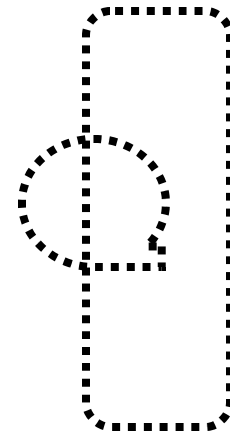
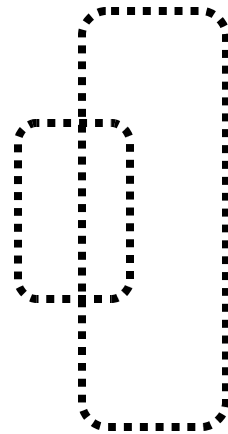
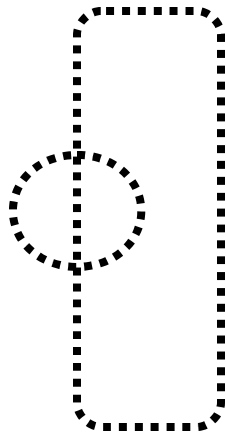

### ASSOCIAZIONI LOGICHE

Far associare le immagini secondo un legame logico.

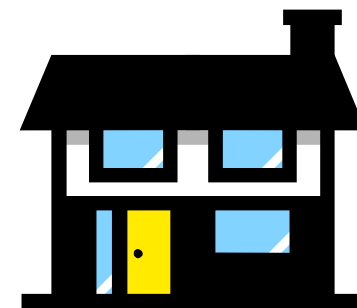
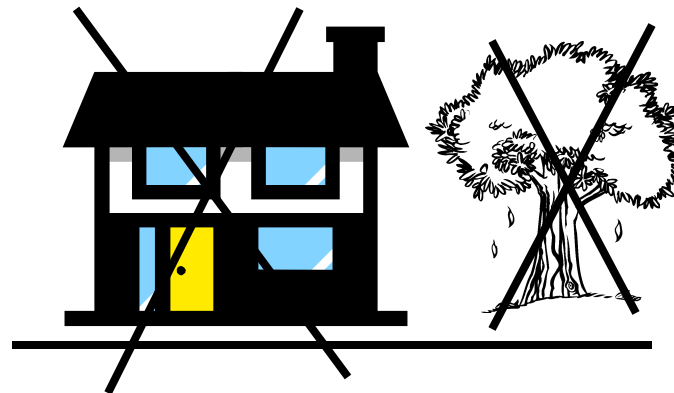

## ASSOCIAZIONI LOGICHE

Far associare le immagini secondo un legame logico.

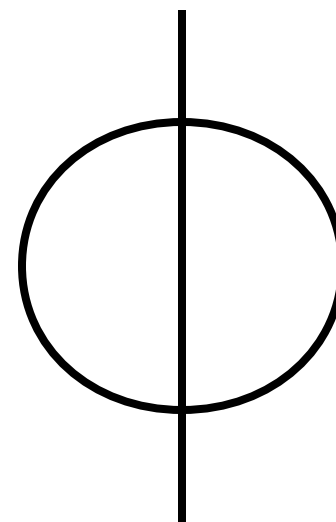
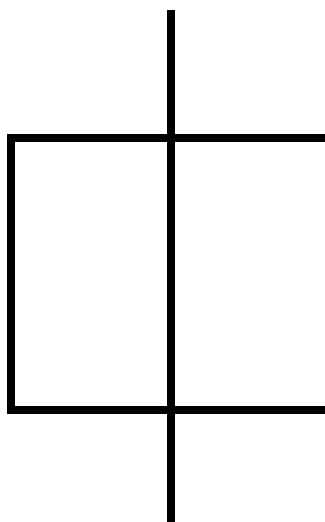
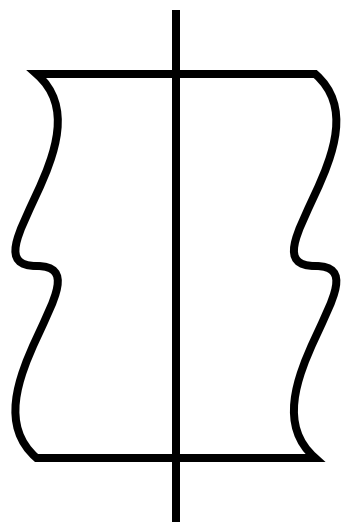

### ASSOCIAZIONI LOGICHE

Far associare le immagini secondo un legame logico.

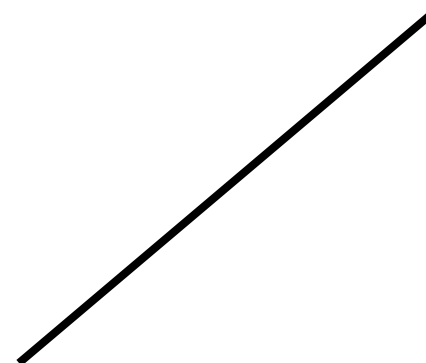
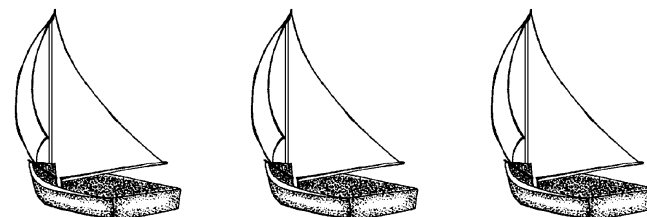
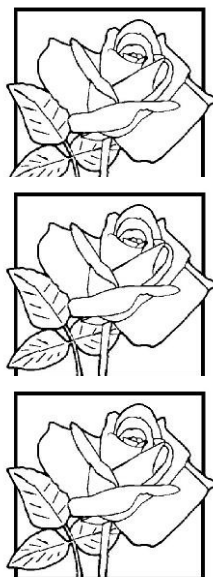
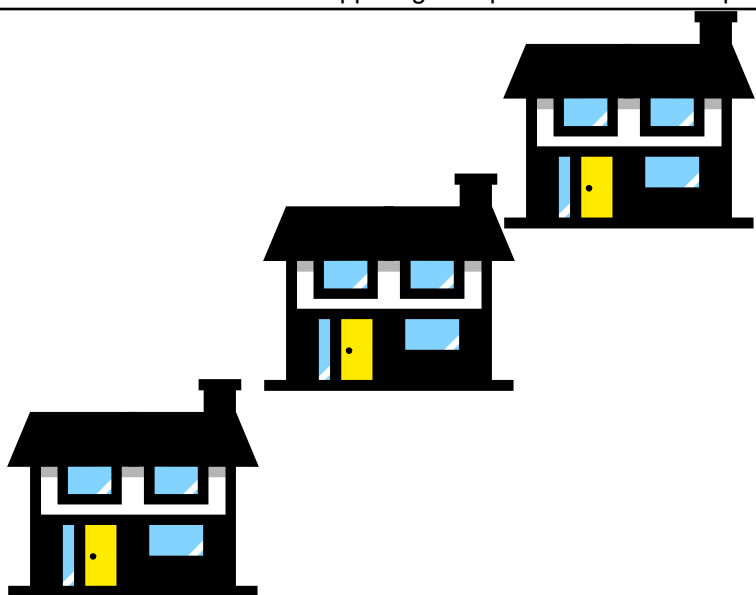

## ASSOCIAZIONI LOGICHE

Far associare le immagini secondo un legame logico.

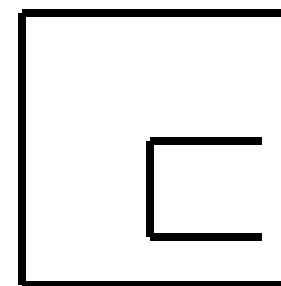
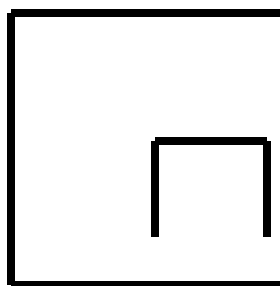
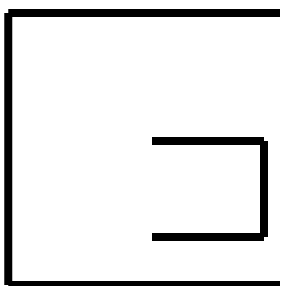
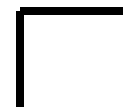
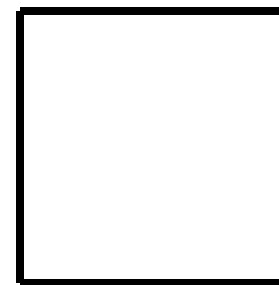
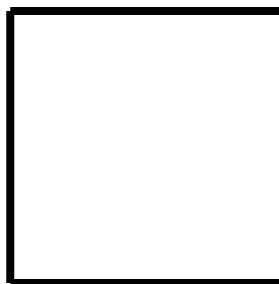
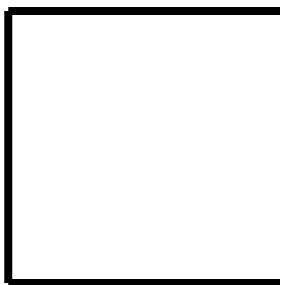

## ASSOCIAZIONI LOGICHE

Far associare le immagini secondo un legame logico.



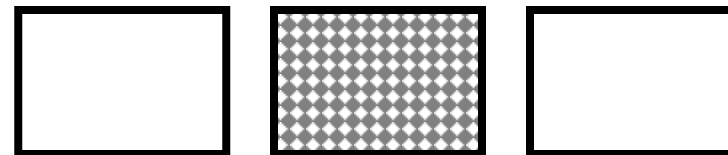
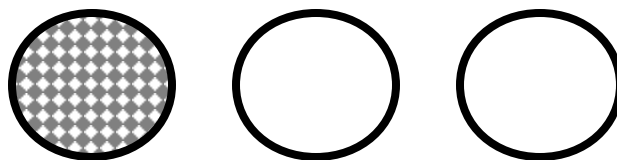
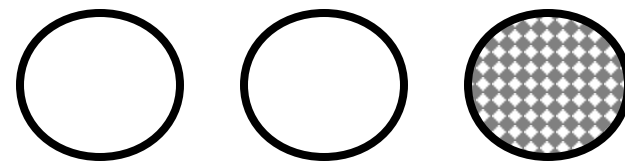
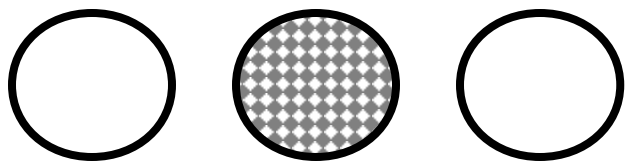

## ASSOCIAZIONI LOGICHE

Far associare le immagini secondo un legame logico.

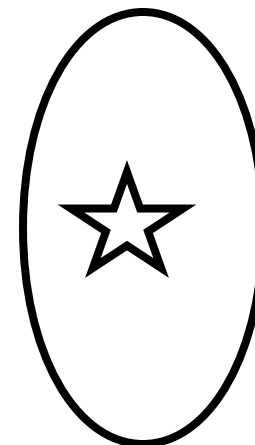
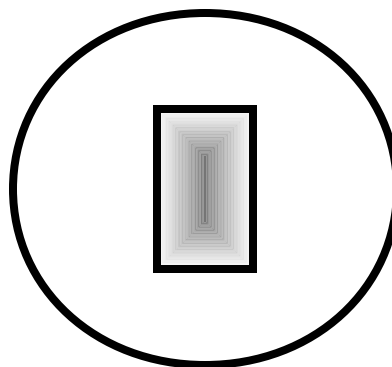
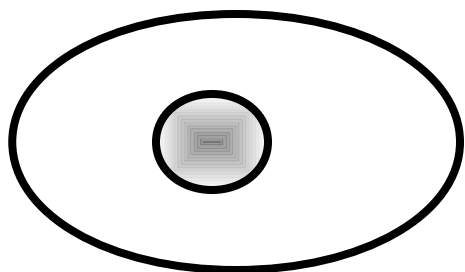
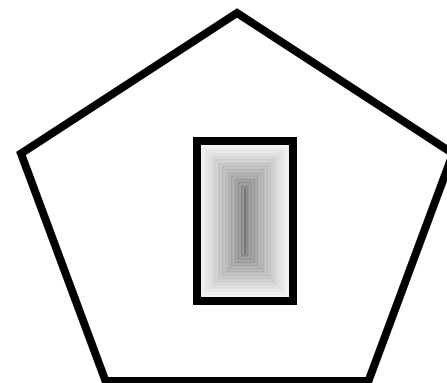
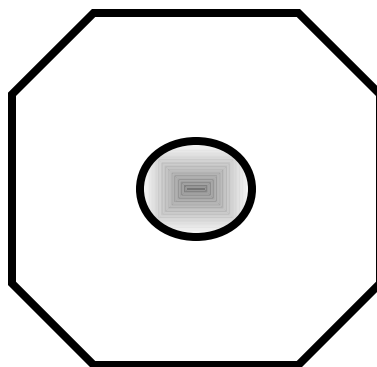
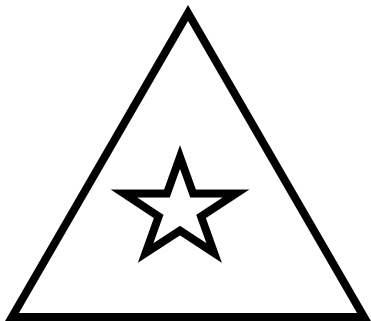

### ASSOCIAZIONI LOGICHE

Far associare le immagini secondo un legame logico.

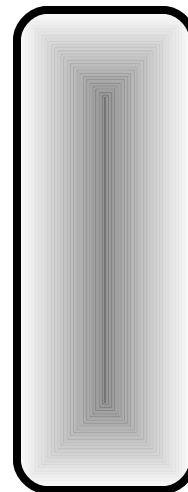
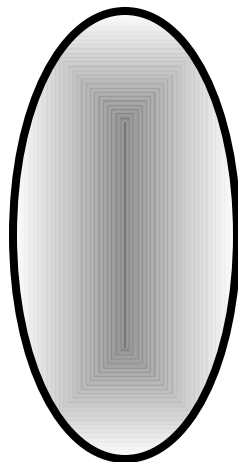
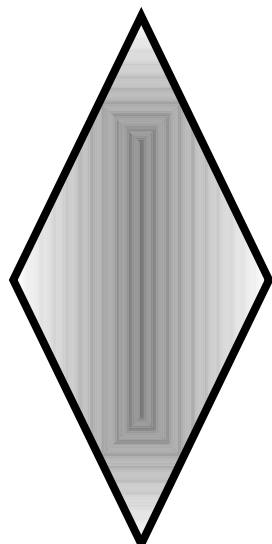
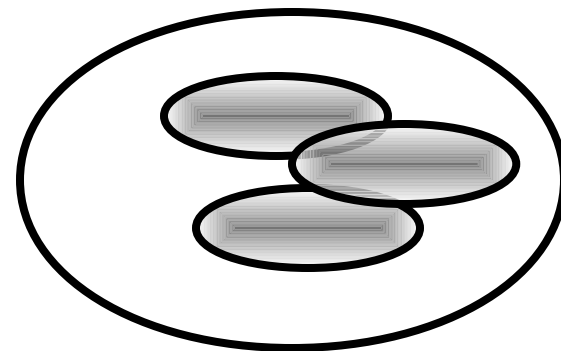
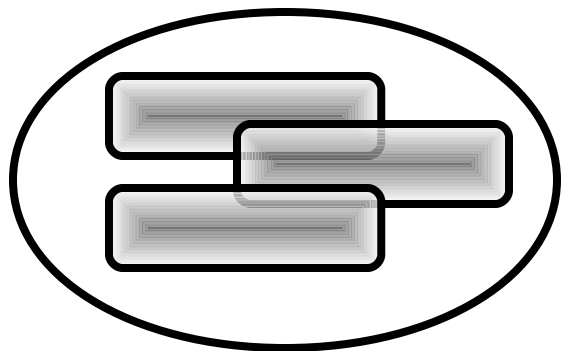
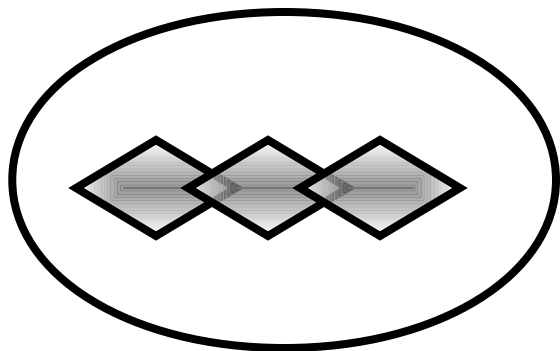

### ASSOCIAZIONI LOGICHE

Far associare le immagini secondo un legame logico.

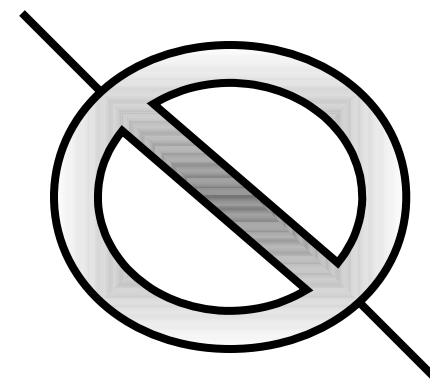
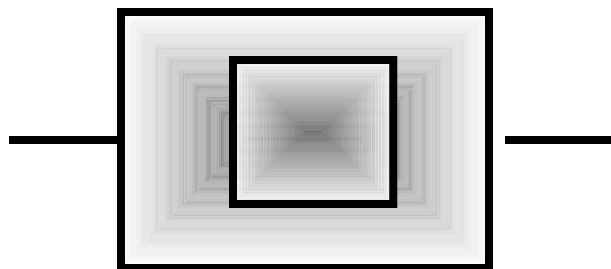
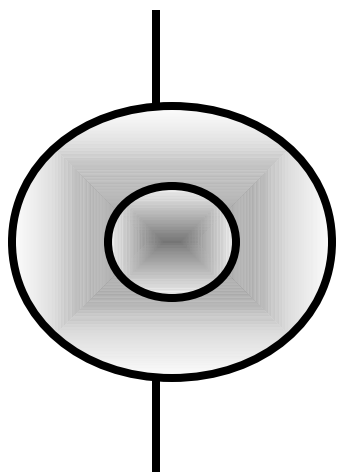

## ASSOCIAZIONI LOGICHE

Far associare le immagini secondo un legame logico.

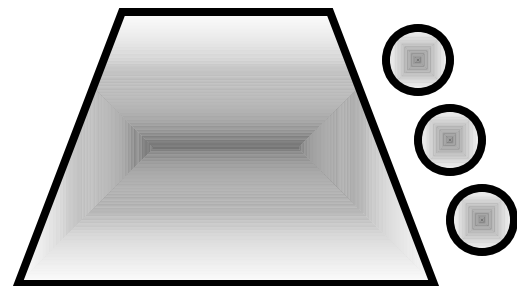
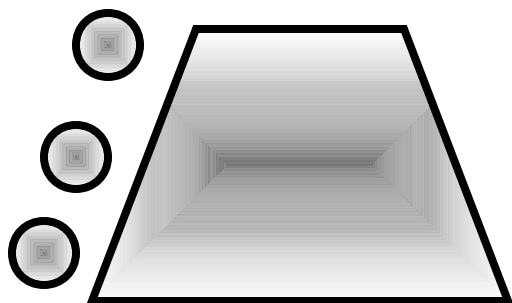
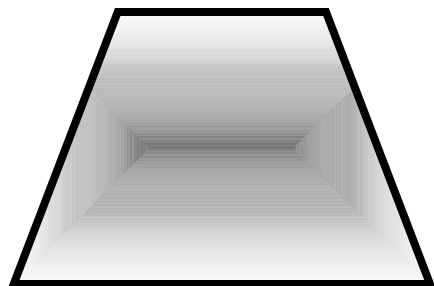
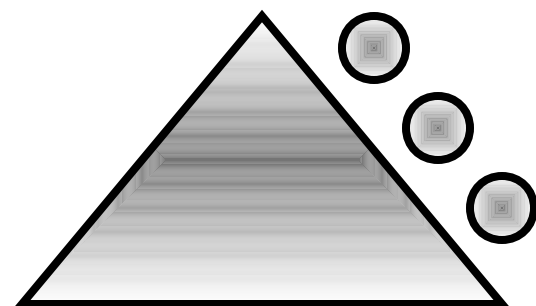
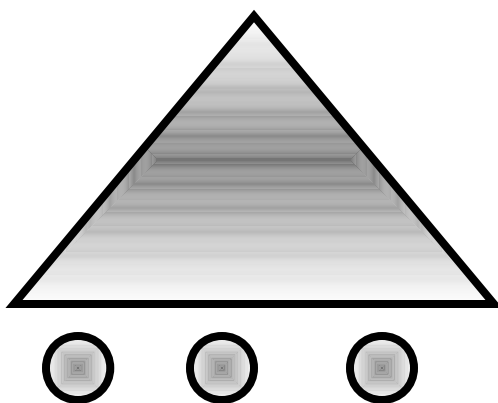
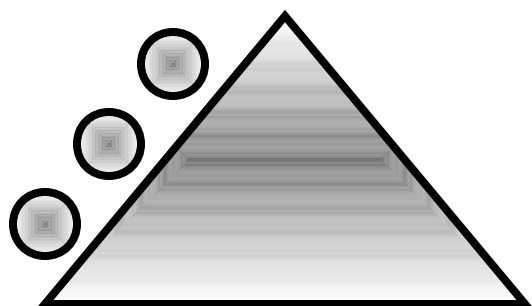

## ASSOCIAZIONI LOGICHE

Far associare le immagini secondo un legame logico.

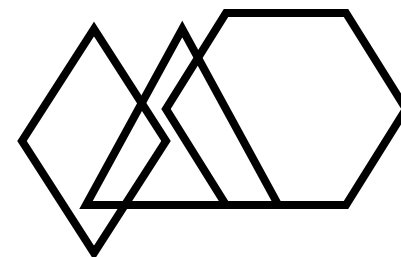
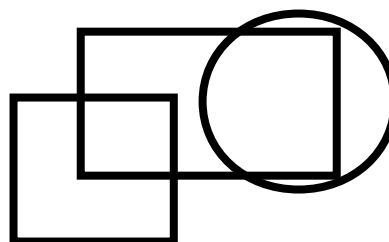
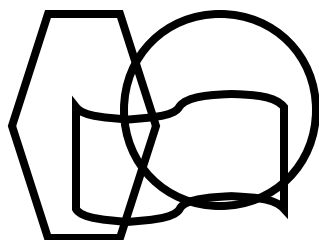
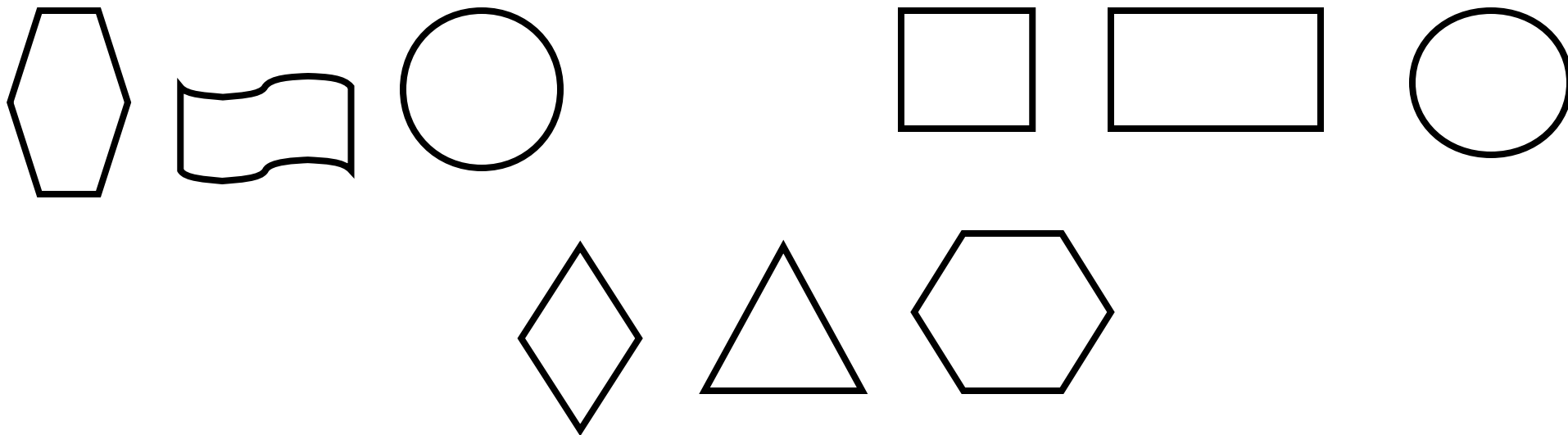

## ASSOCIAZIONI LOGICHE

Far associare le immagini secondo un legame logico.

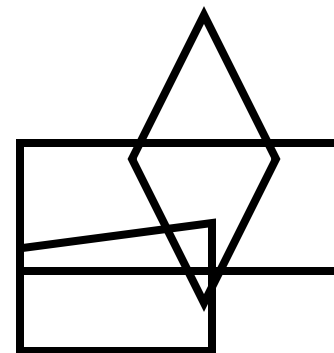
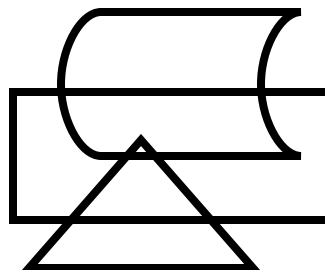
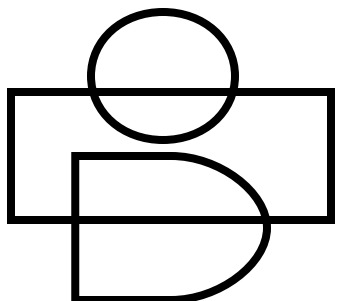
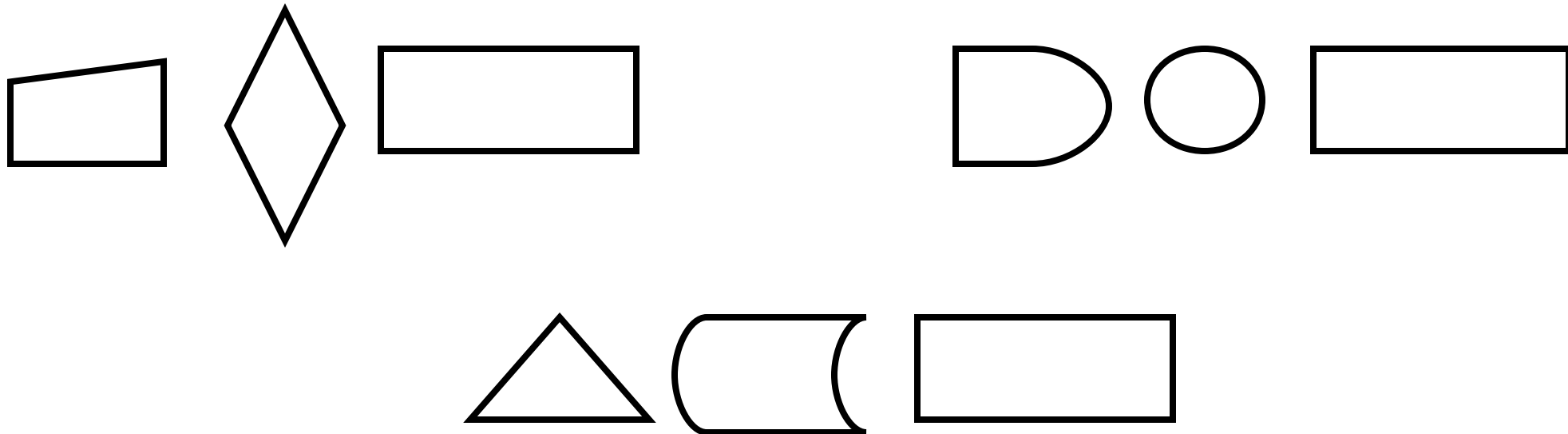

### ASSOCIAZIONI LOGICHE

Far associare le immagini secondo un legame logico.

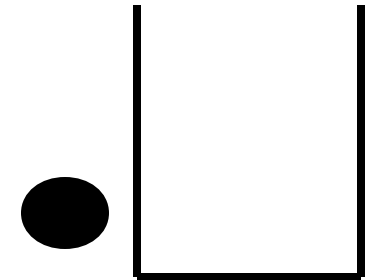
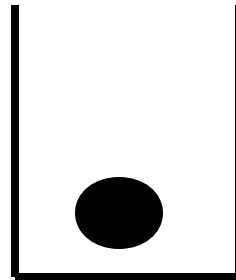
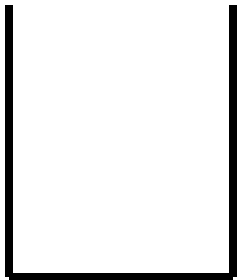
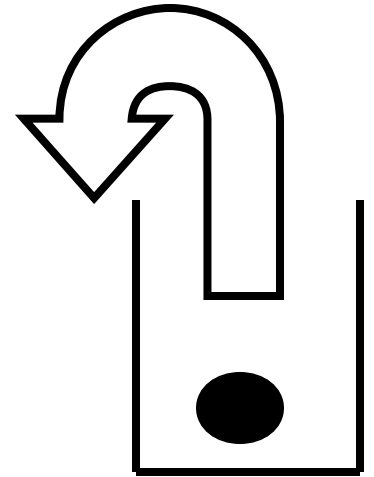
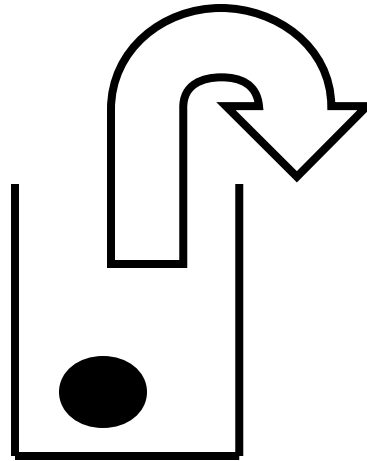
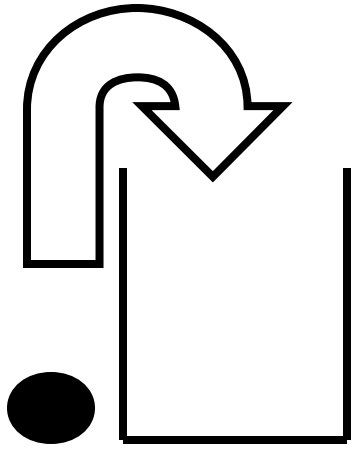

### ASSOCIAZIONI LOGICHE

Far associare le immagini secondo un legame logico.



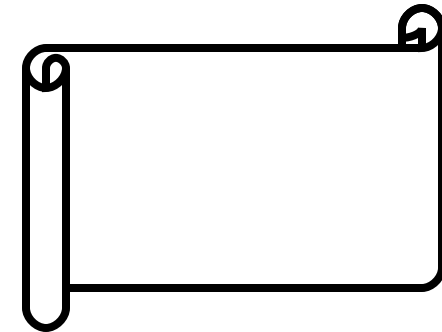
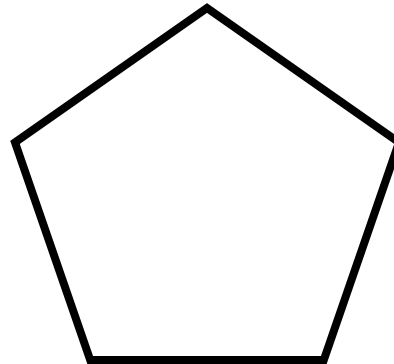
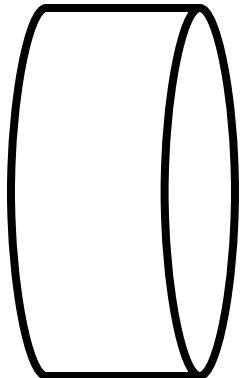
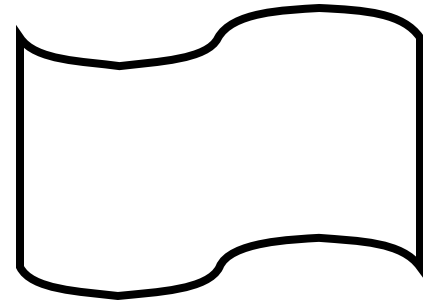
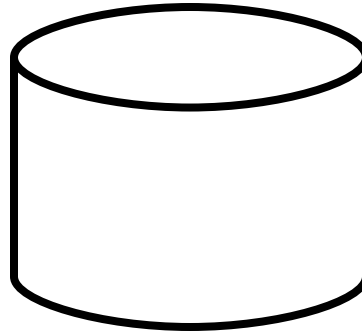
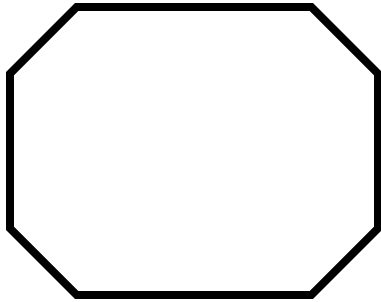

## ASSOCIAZIONI LOGICHE

Far associare le immagini secondo un legame logico.

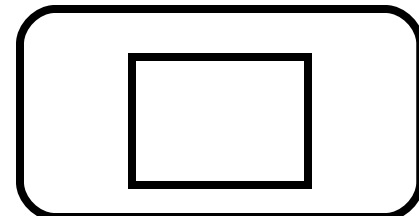
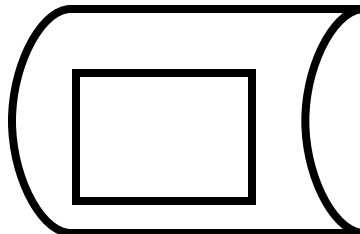
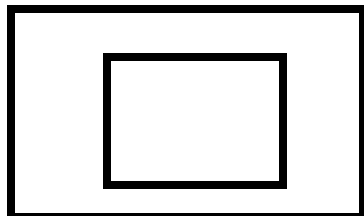
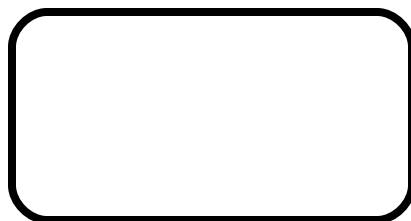
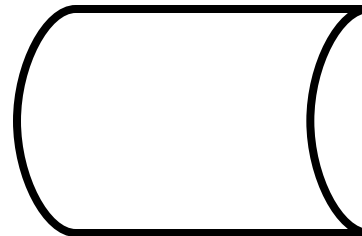
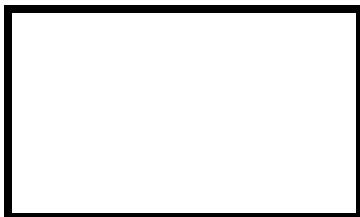

## ASSOCIAZIONI LOGICHE

Far associare le immagini secondo un legame logico.

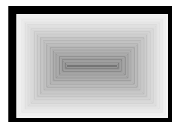
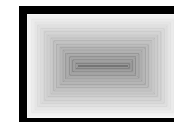
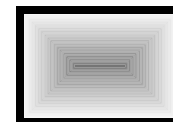
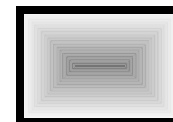
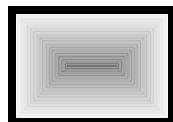
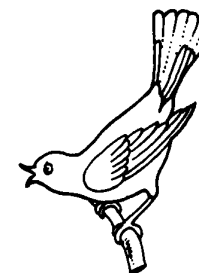
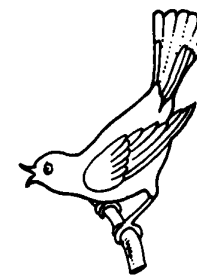
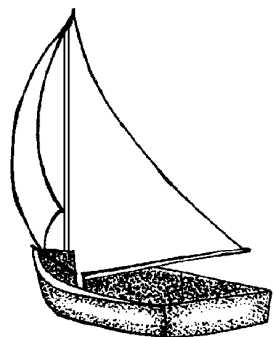

## ASSOCIAZIONI LOGICHE

Far associare le immagini secondo un legame logico.

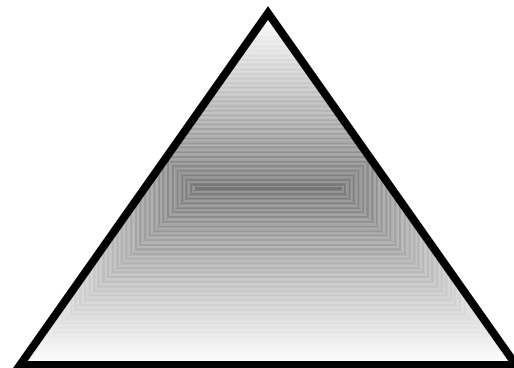
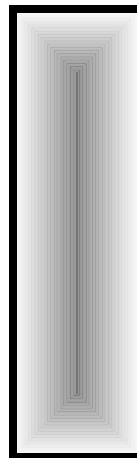
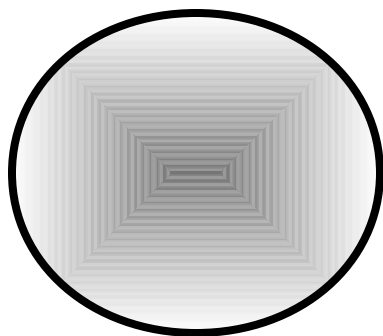
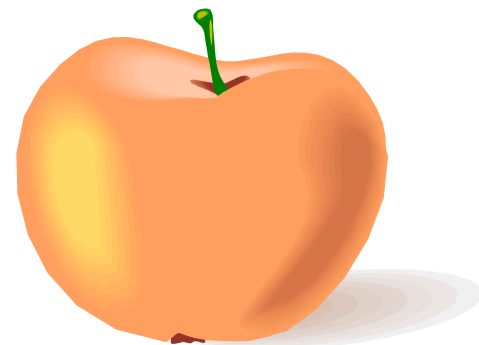

## ASSOCIAZIONI LOGICHE

Far associare le immagini secondo un legame logico.

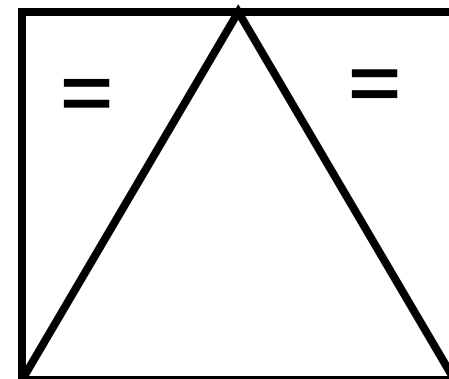
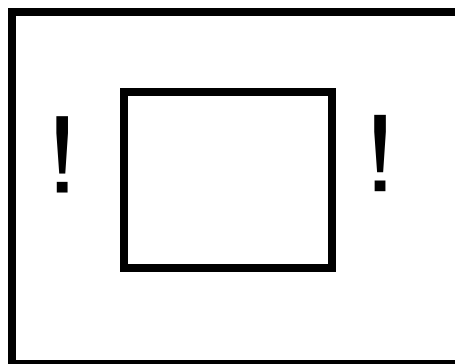
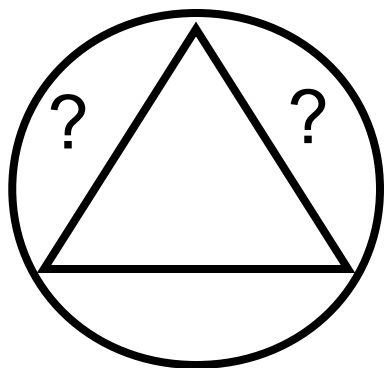

=

?

!

### ASSOCIAZIONI LOGICHE

Far associare le immagini secondo un legame logico.

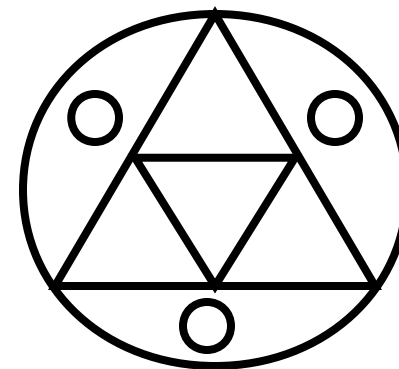
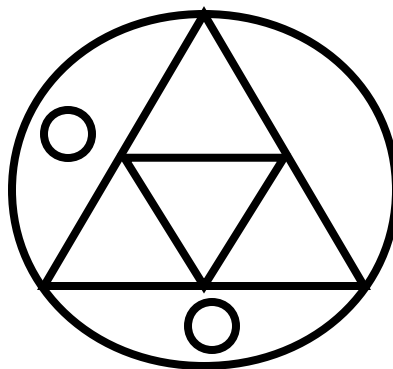
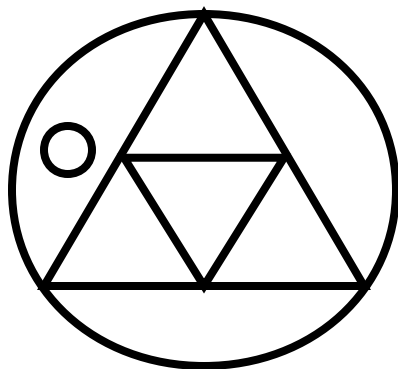

## ASSOCIAZIONI LOGICHE

Far associare le immagini secondo un legame logico.

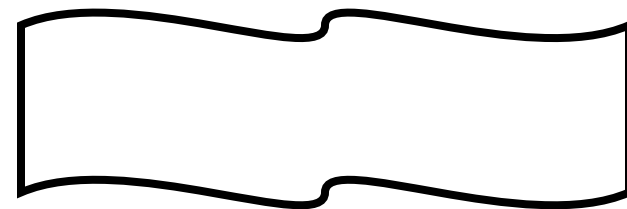
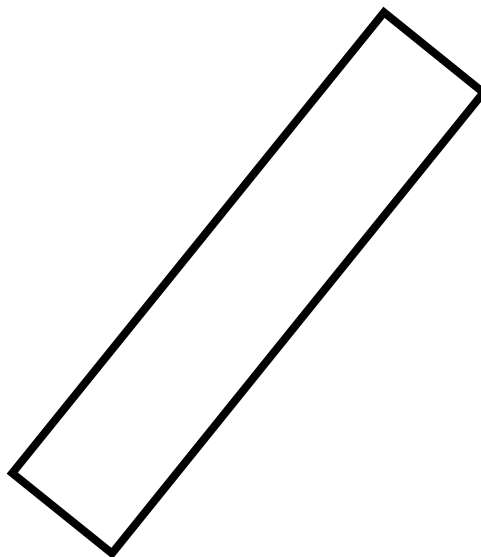
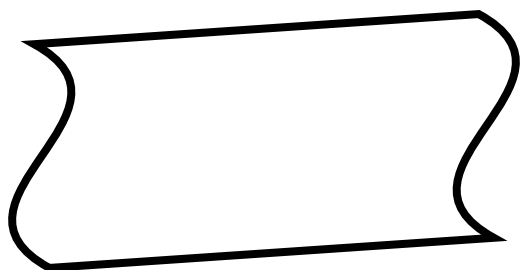
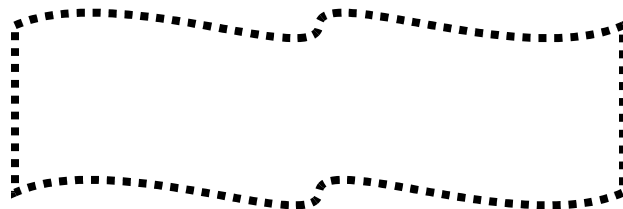
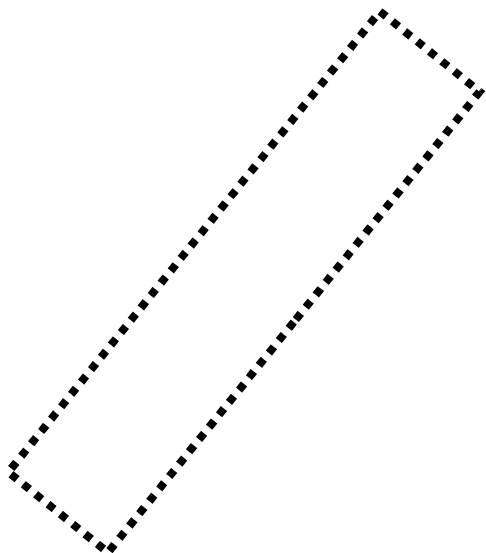

### ASSOCIAZIONI LOGICHE

Far associare le immagini secondo un legame logico.

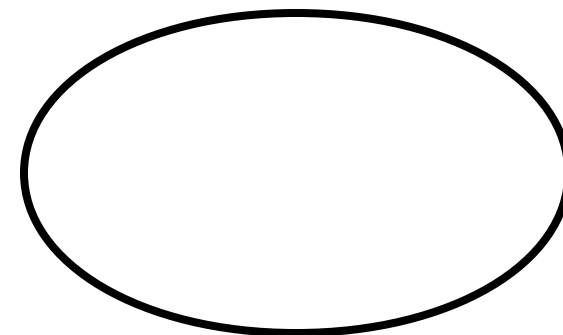
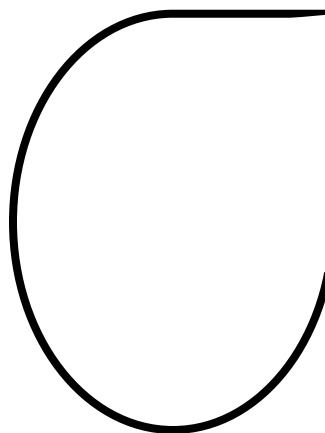
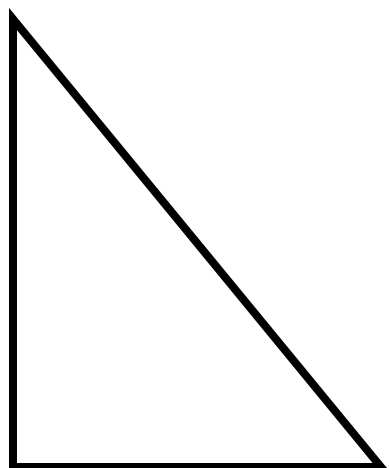
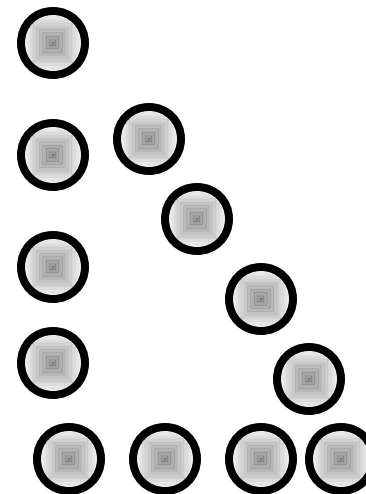
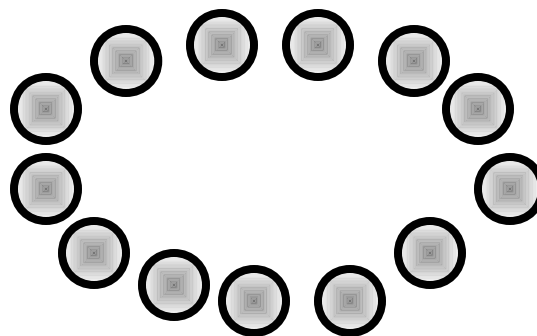
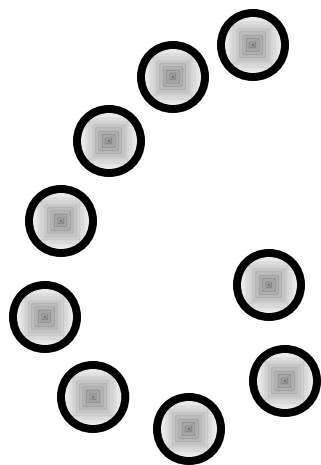

### ASSOCIAZIONI LOGICHE

Far associare le immagini secondo un legame logico.



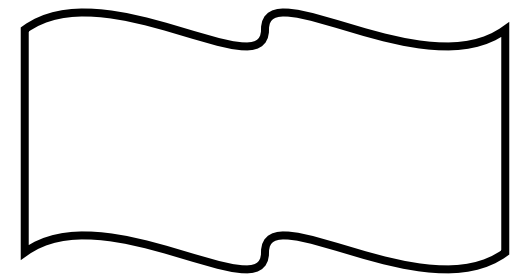
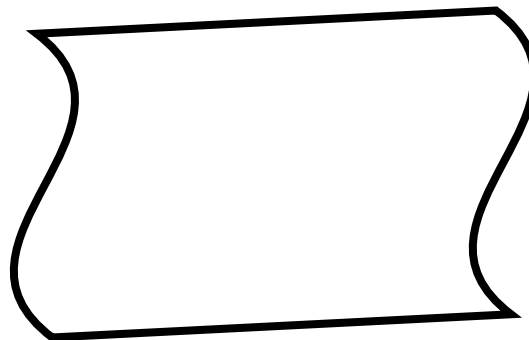
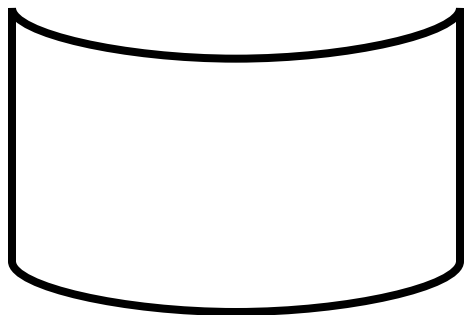
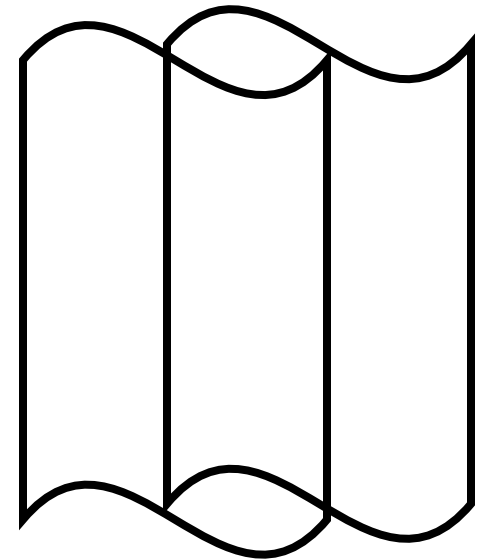
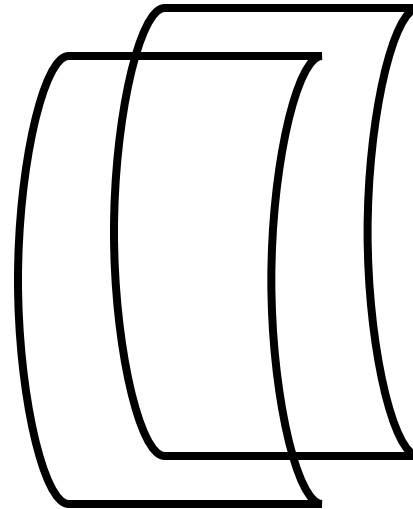
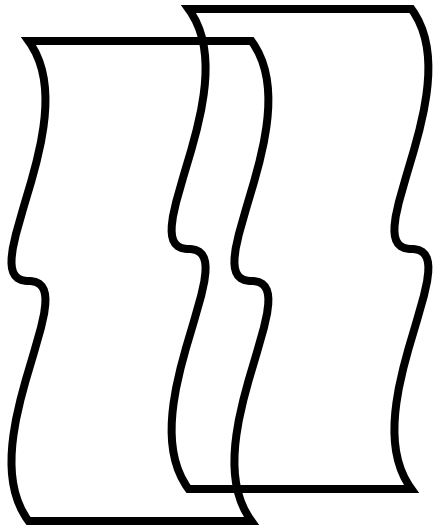

### ASSOCIAZIONI LOGICHE

Far associare le immagini secondo un legame logico.

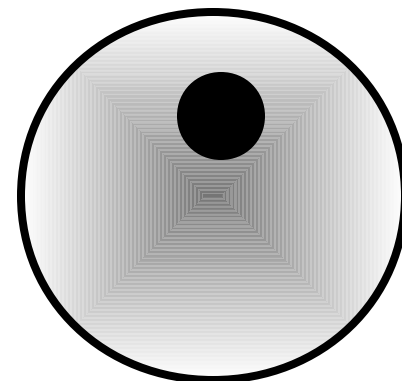
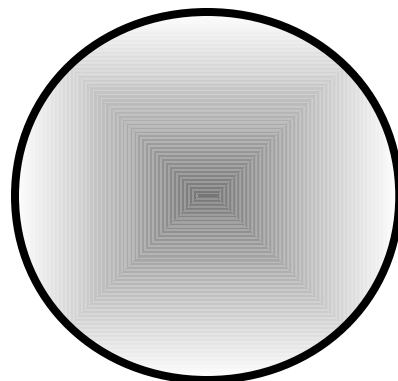
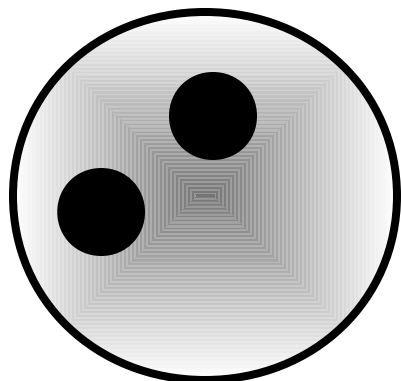
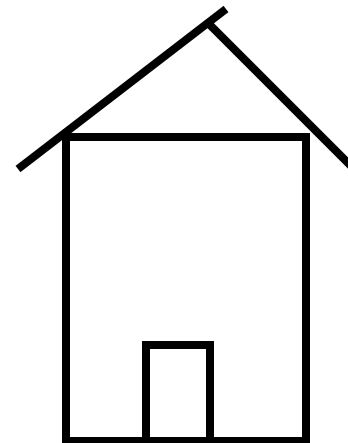
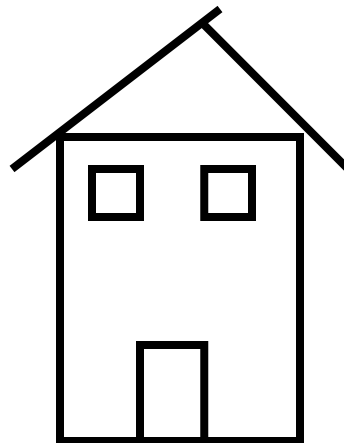
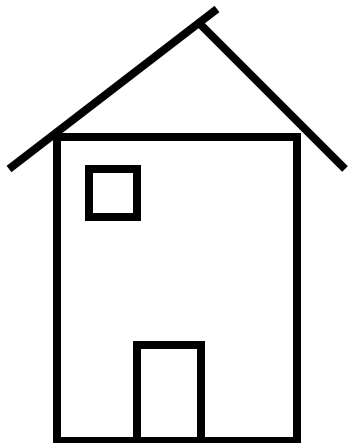

### ASSOCIAZIONI LOGICHE

Far associare le immagini secondo un legame logico.

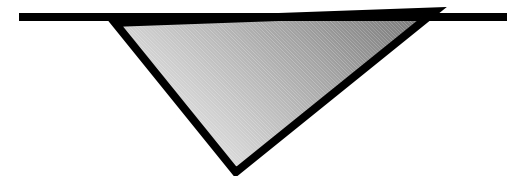
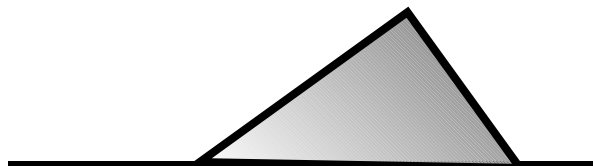
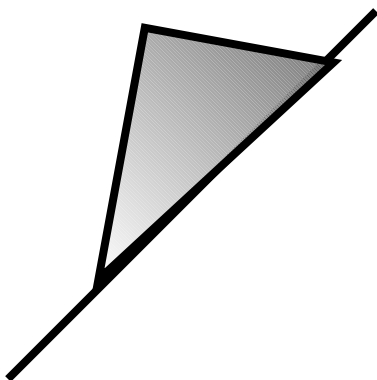
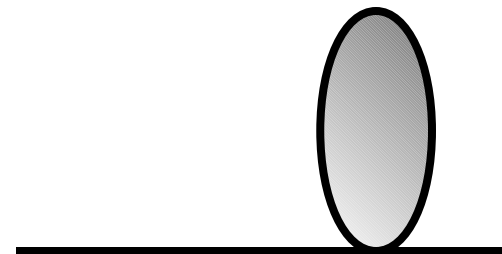
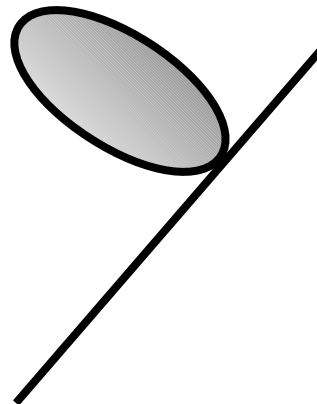
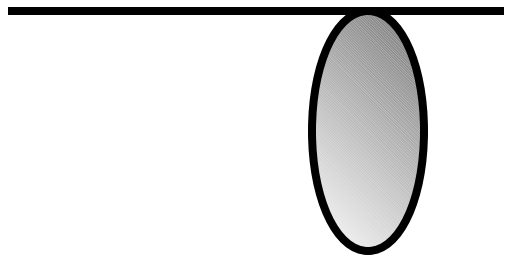

### ASSOCIAZIONI LOGICHE

Far associare le immagini secondo un legame logico.

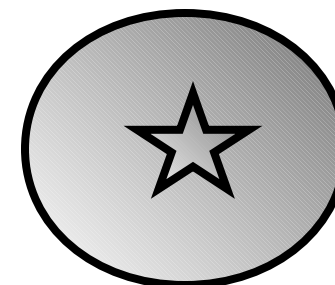
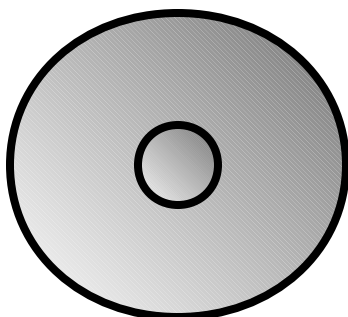
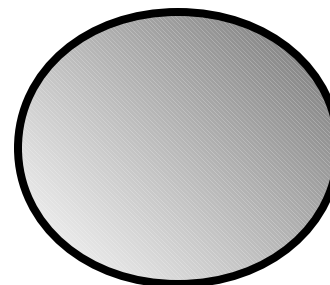
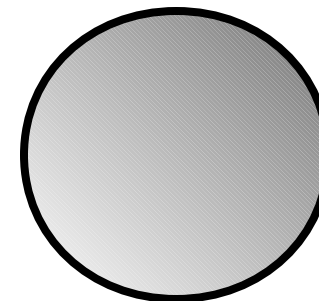
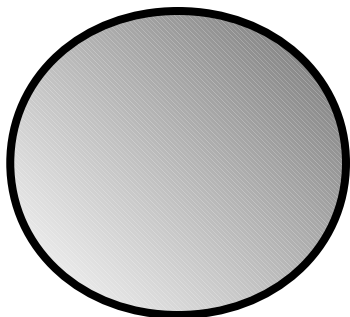

## ASSOCIAZIONI LOGICHE

Far associare le immagini secondo un legame logico.

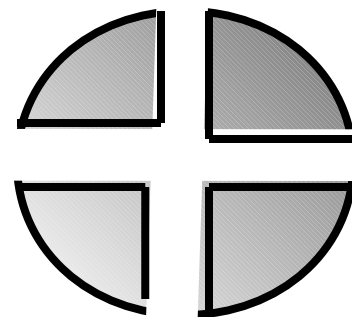
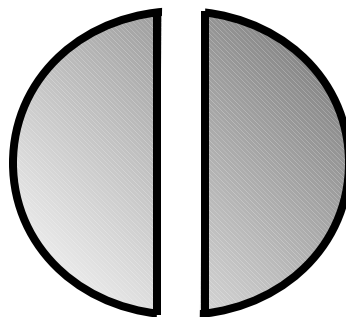
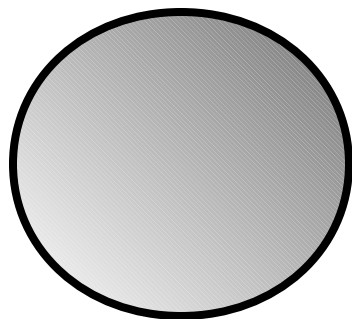
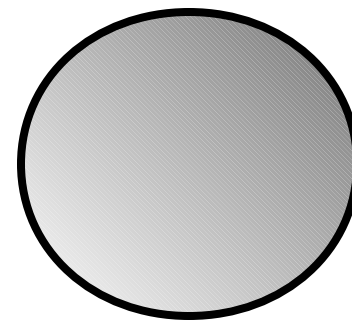
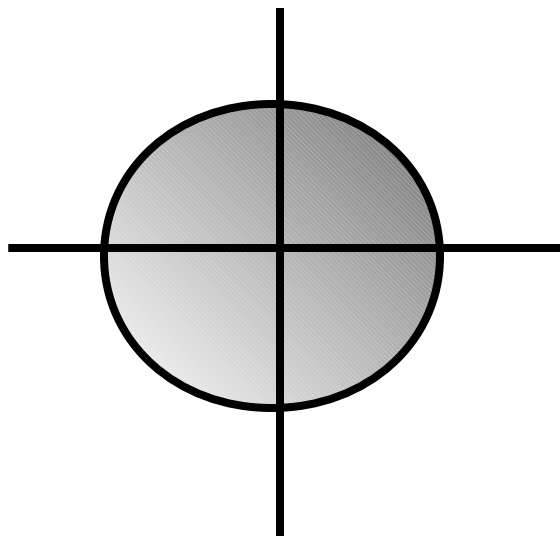
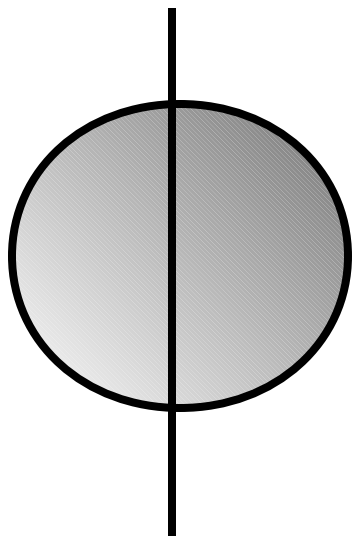

## ASSOCIAZIONI LOGICHE

Far associare le immagini secondo un legame logico.

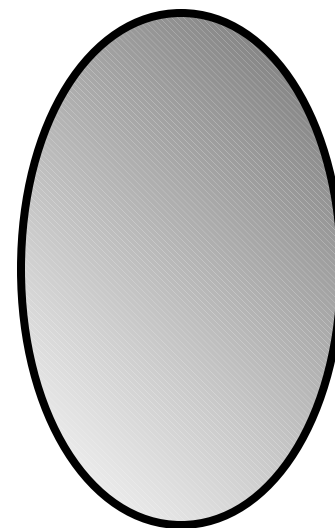
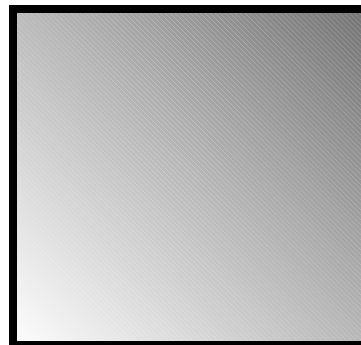
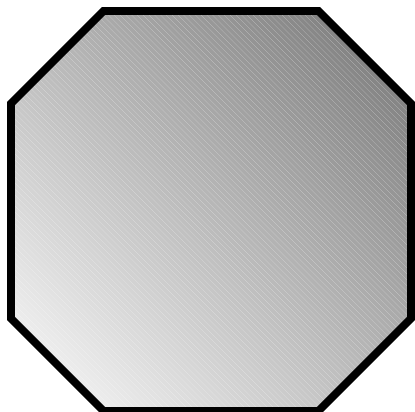
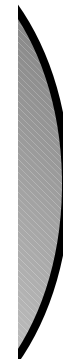
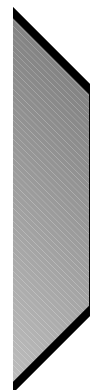
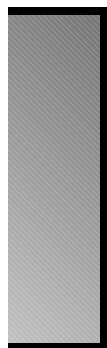

### ASSOCIAZIONI LOGICHE

Far associare le immagini secondo un legame logico.

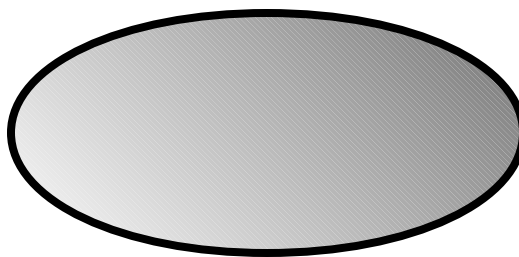
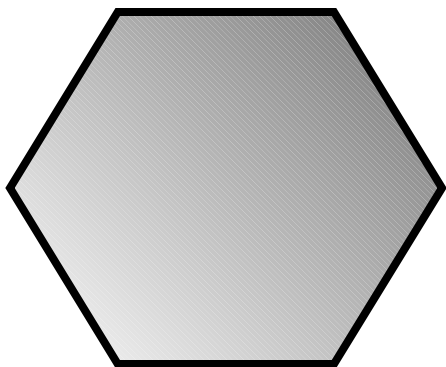
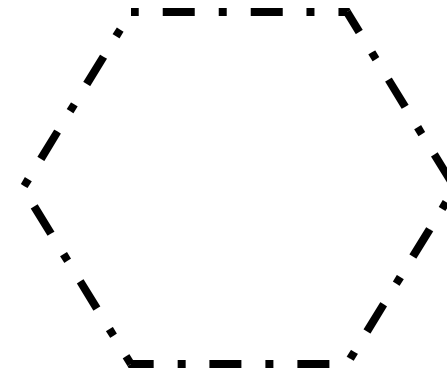
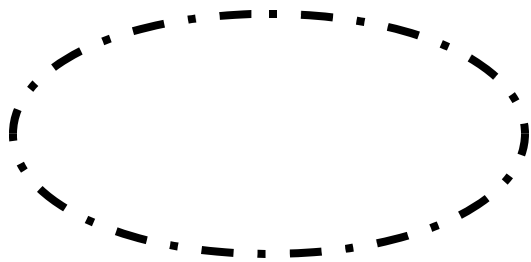

### ASSOCIAZIONI LOGICHE

Far associare le immagini secondo un legame logico.

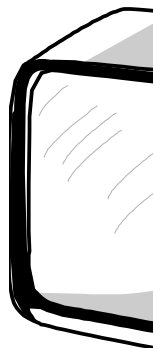
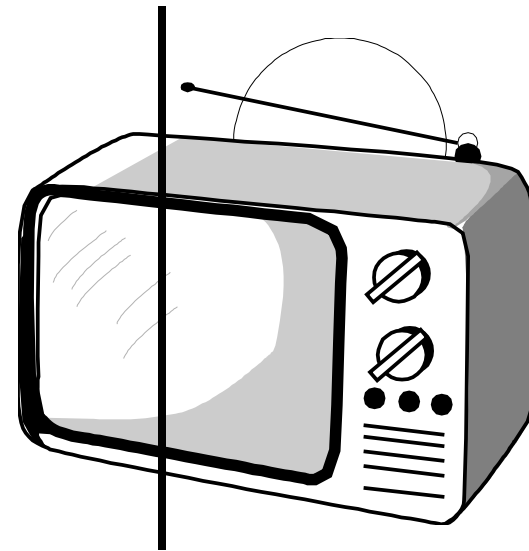
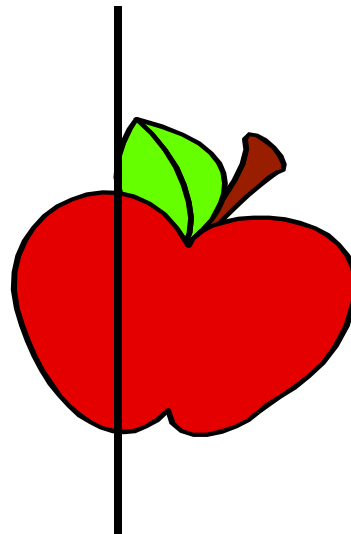
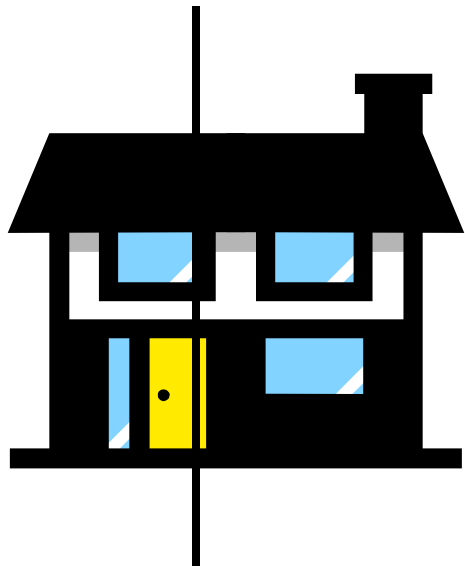

## ASSOCIAZIONI LOGICHE

Far associare le immagini secondo un legame logico.



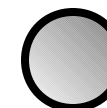
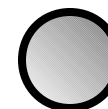
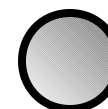
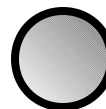
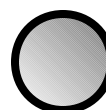
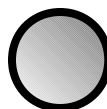
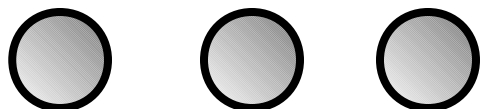
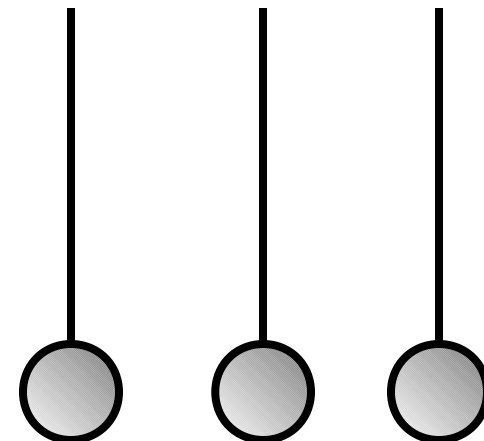
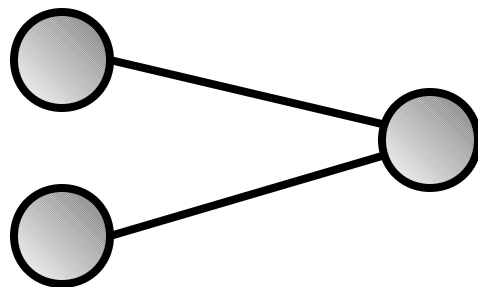
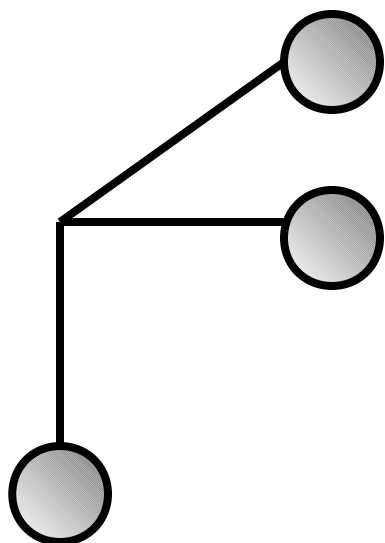

## ASSOCIAZIONI LOGICHE

Far associare le immagini secondo un legame logico.

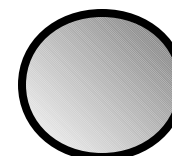
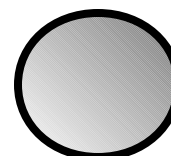
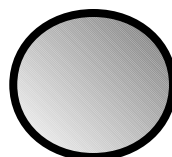
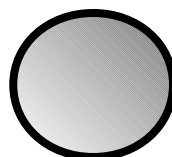
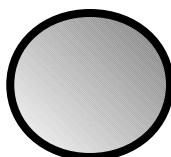
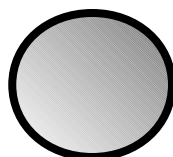
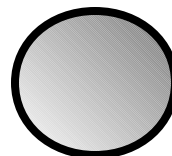
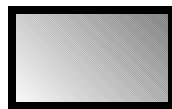
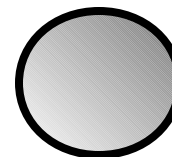
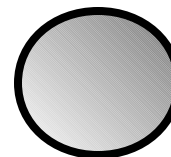
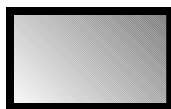
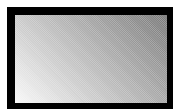

## ASSOCIAZIONI LOGICHE

Far associare le immagini secondo un legame logico.

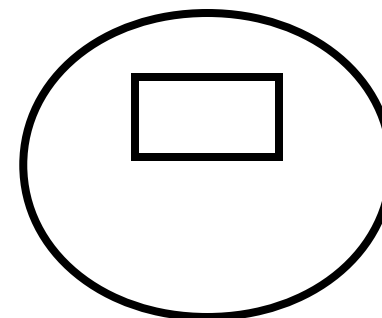
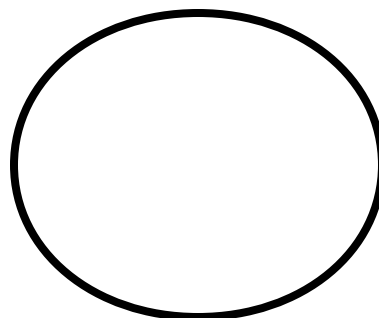
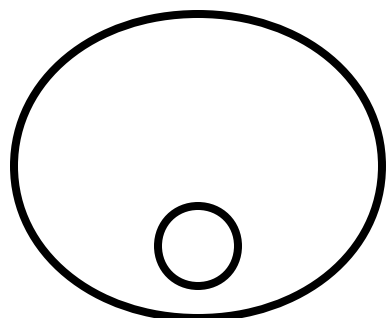
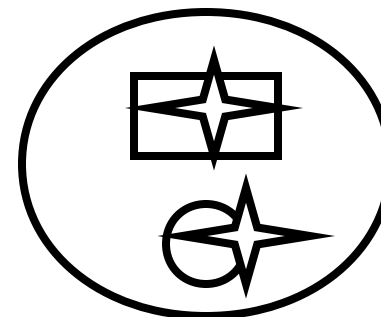
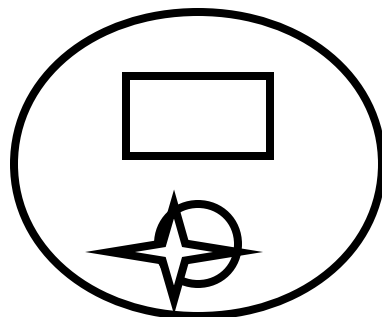
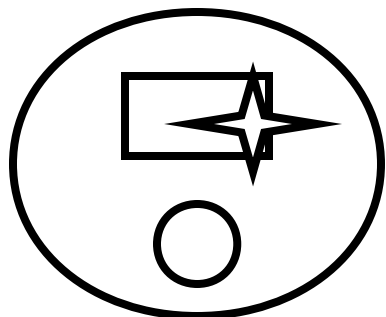

### ASSOCIAZIONI LOGICHE

Far associare le immagini secondo un legame logico.

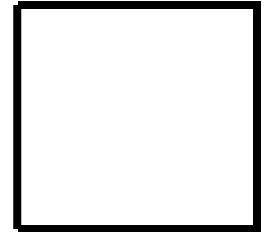
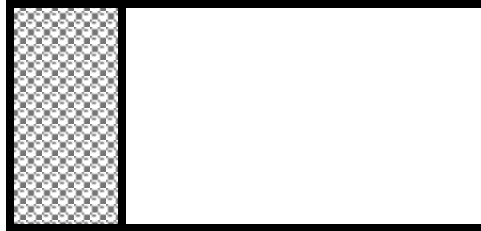
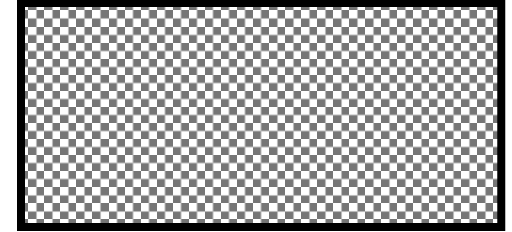
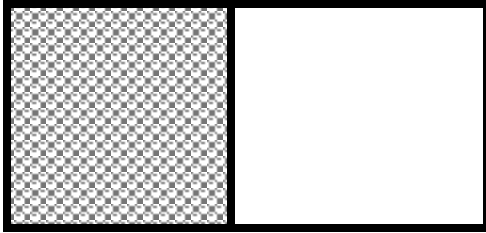

## ASSOCIAZIONI LOGICHE

Far associare secondo un legame logico.

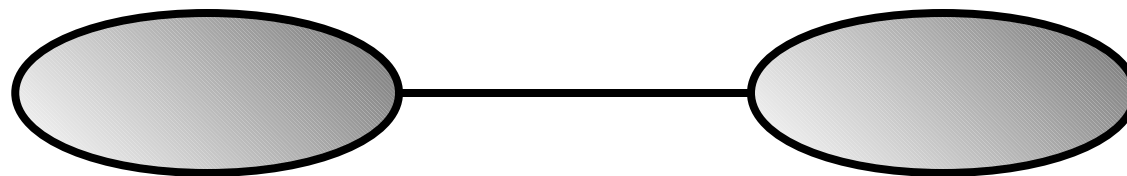
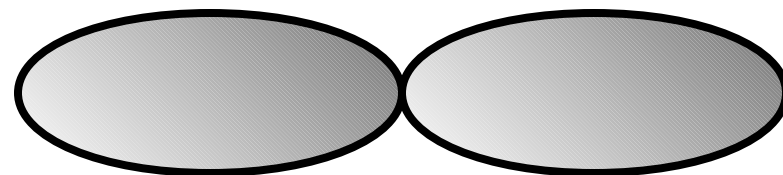
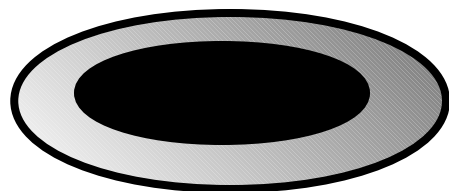
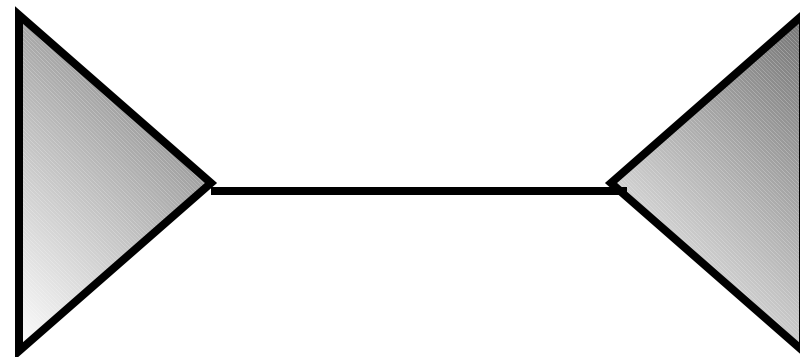
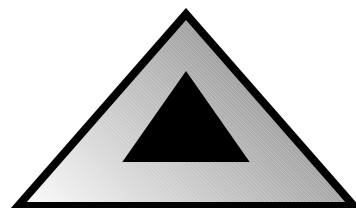
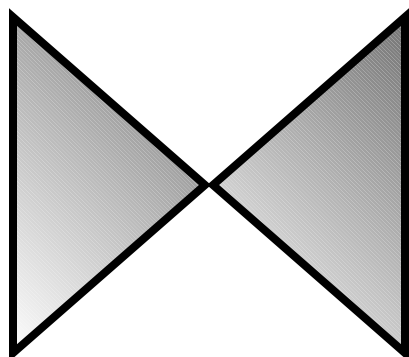

### ASSOCIAZIONI LOGICHE

Far associare secondo un legame logico.

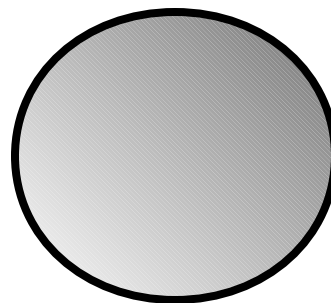
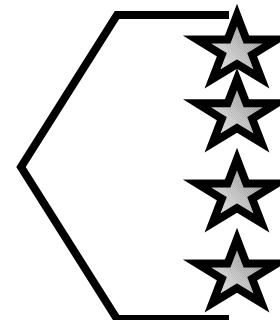
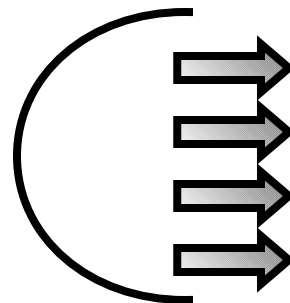
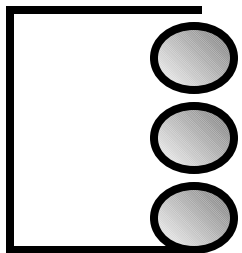

## ASSOCIAZIONI LOGICHE

Far associare secondo un legame logico.

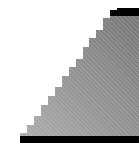
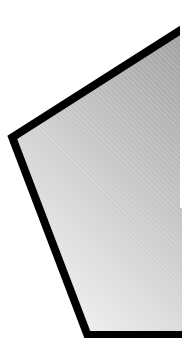
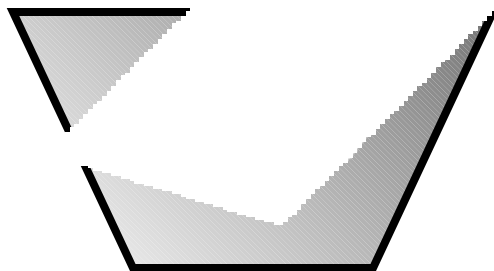
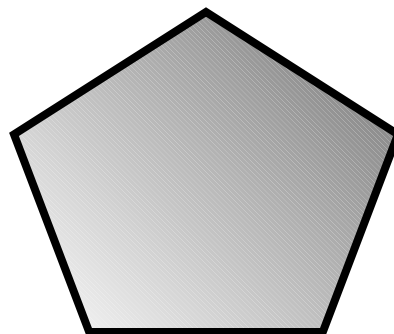
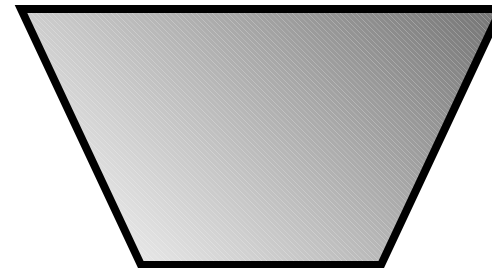
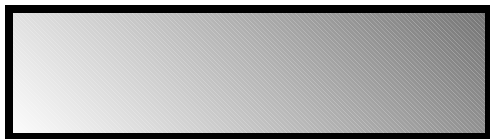

### ASSOCIAZIONI LOGICHE

Far associare secondo un legame logico.

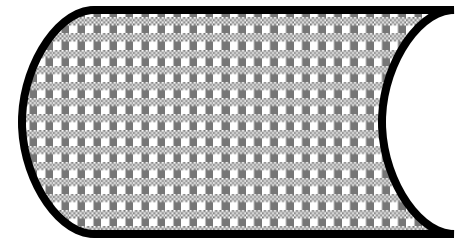
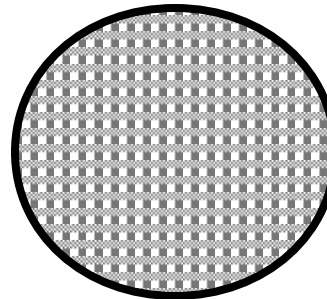
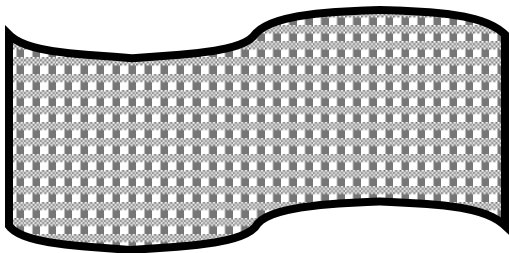
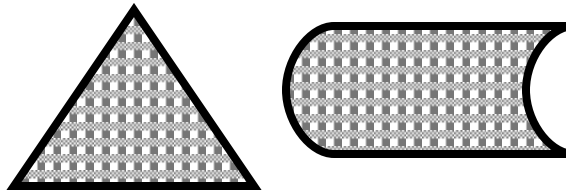
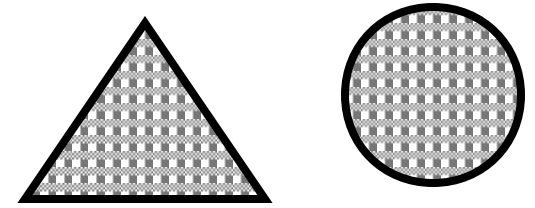
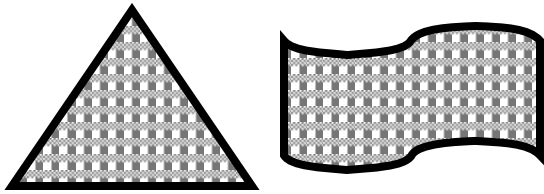

## ASSOCIAZIONI LOGICHE

Far associare secondo un legame logico.



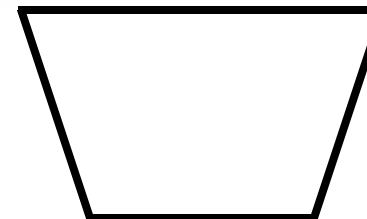
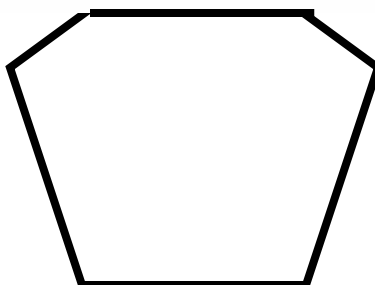
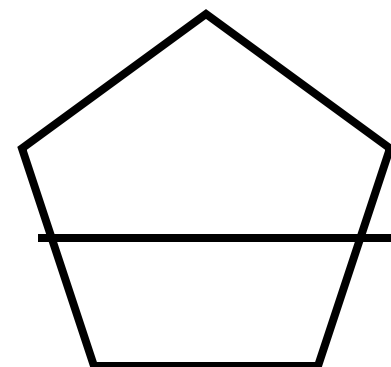
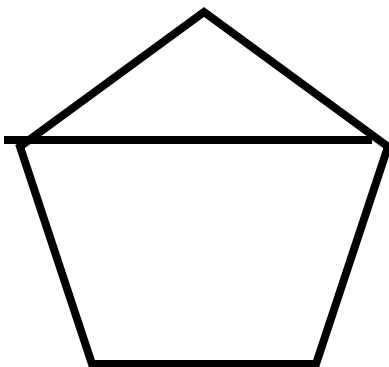
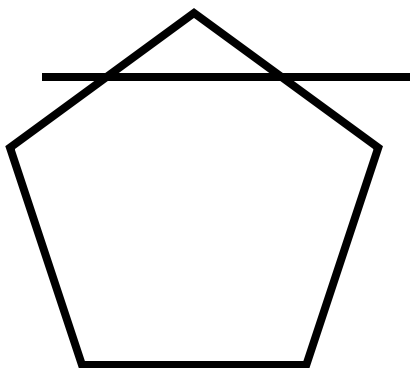

### ASSOCIAZIONI LOGICHE

Far associare secondo un legame logico.

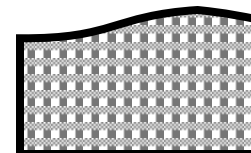
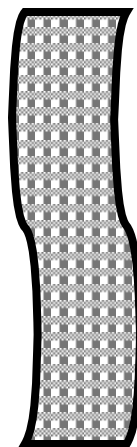
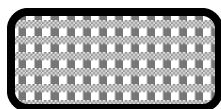
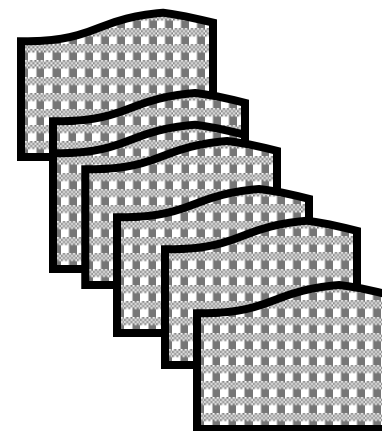
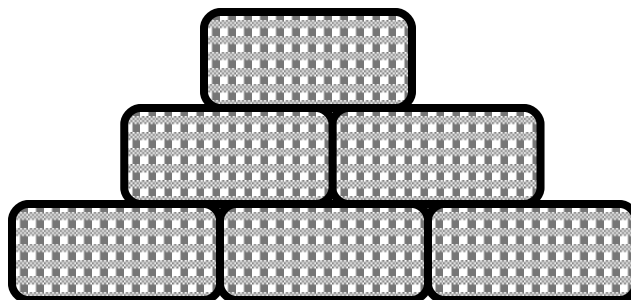
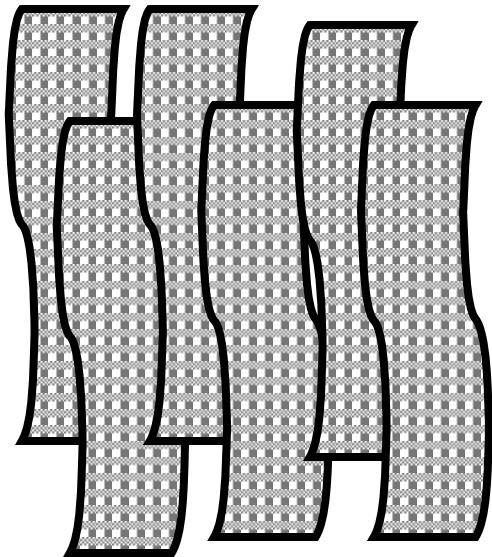

## ASSOCIAZIONI LOGICHE

Far associare secondo un legame logico.

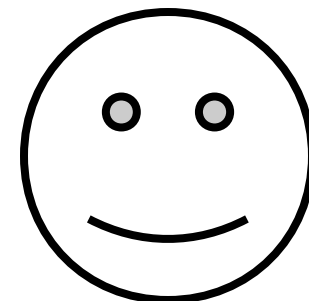
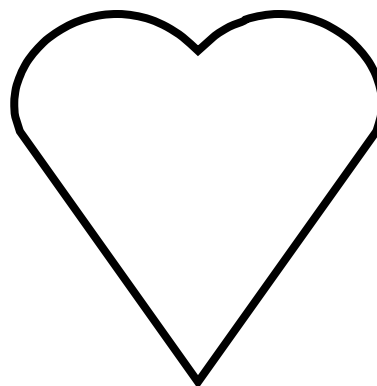
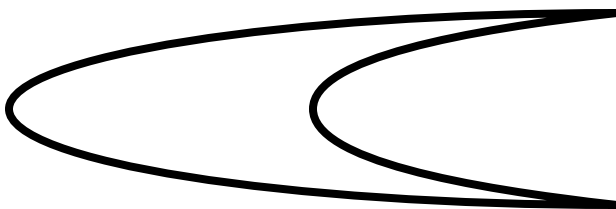
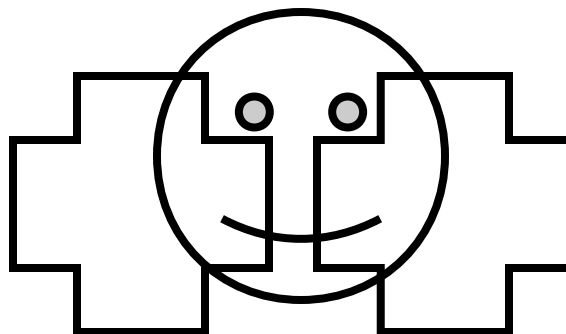
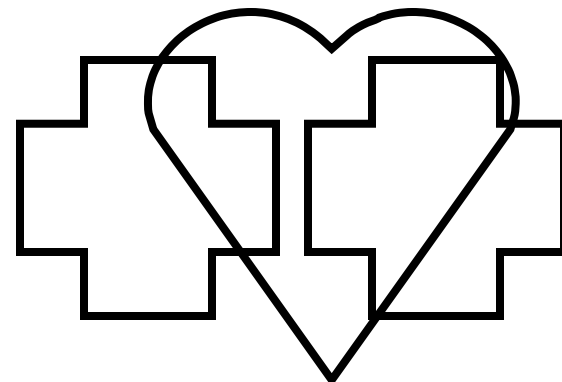
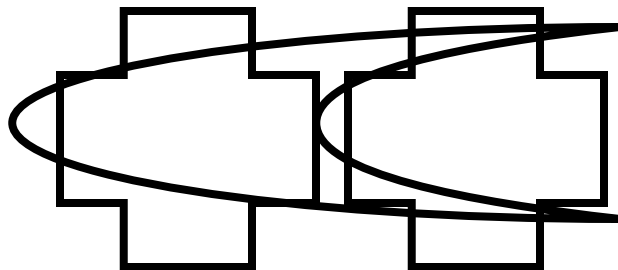

ASSOCIAZIONI LOGICHE

Far associare secondo un legame logico.

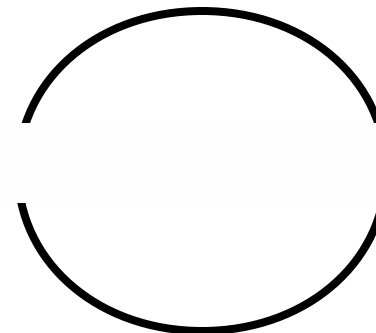
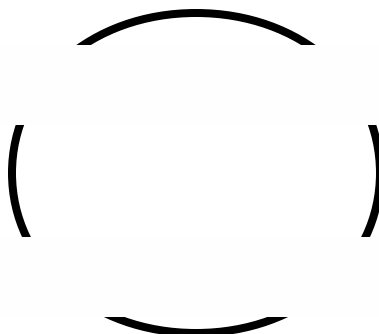
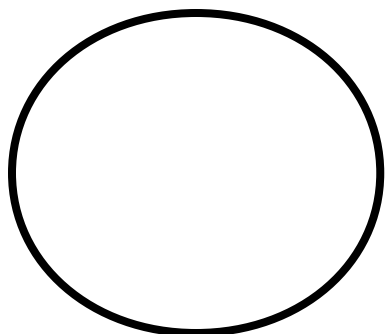
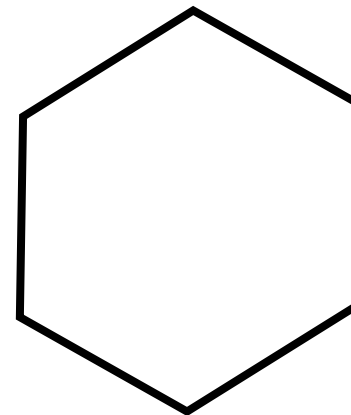
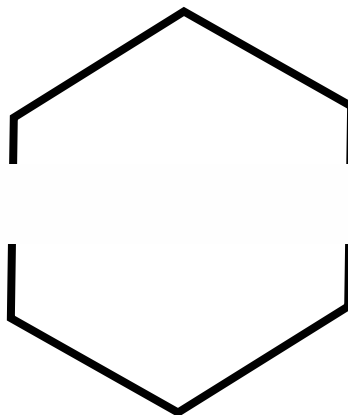
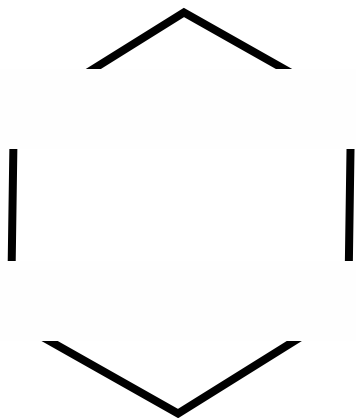

### ASSOCIAZIONI LOGICHE

Far associare secondo un legame logico.

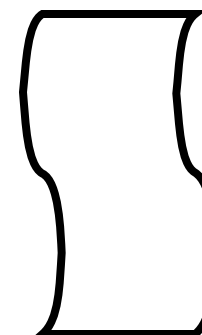
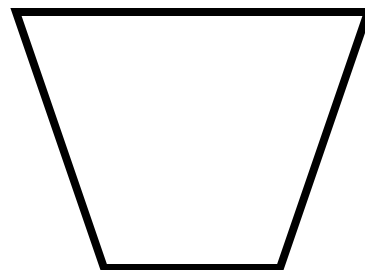
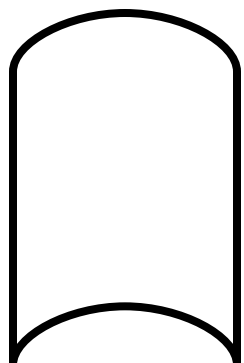
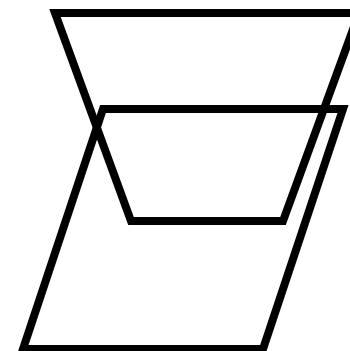
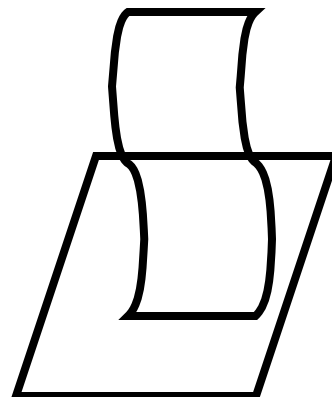
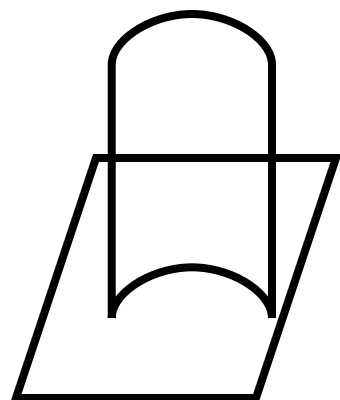

### ASSOCIAZIONI LOGICHE

Far associare secondo un legame logico.

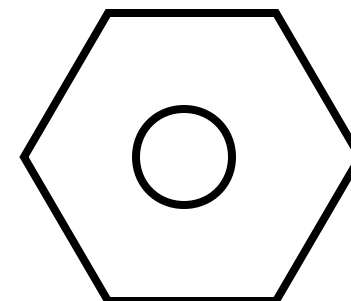
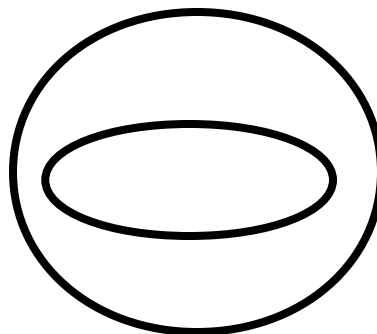
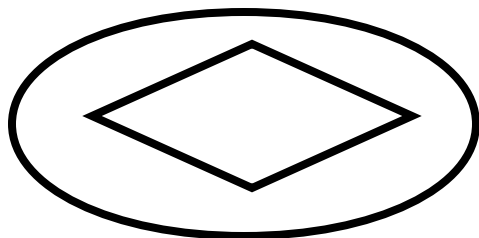
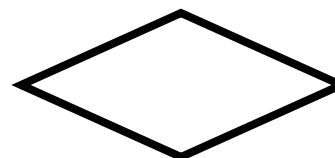
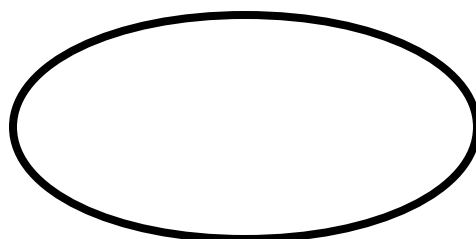
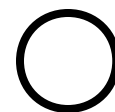
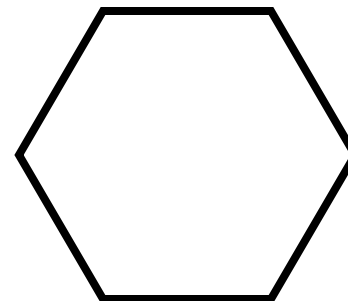
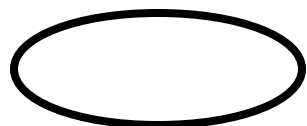
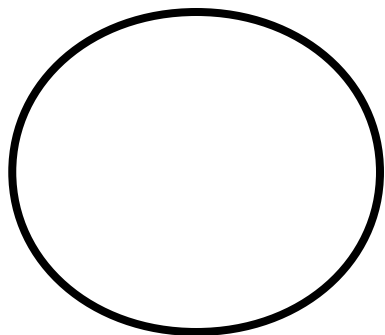

## ASSOCIAZIONI LOGICHE

Far associare secondo un legame logico.

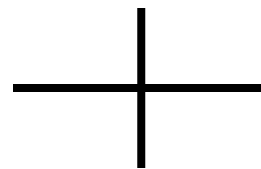
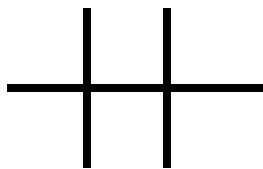
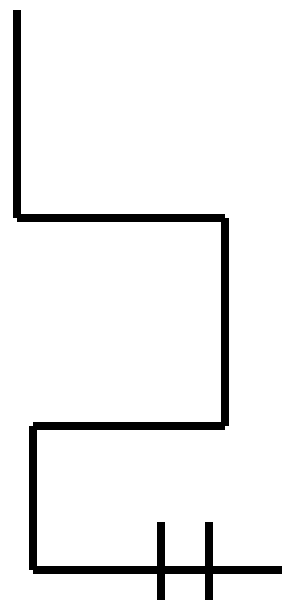
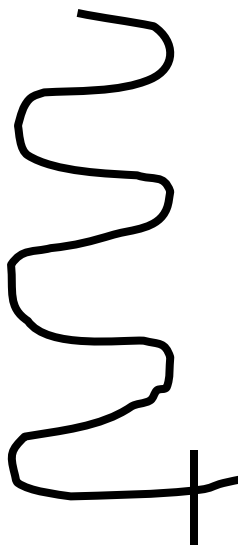
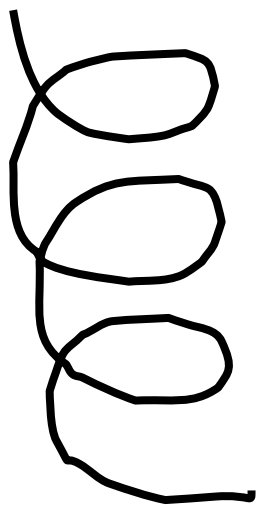

### ASSOCIAZIONI LOGICHE

Far associare secondo un legame logico.

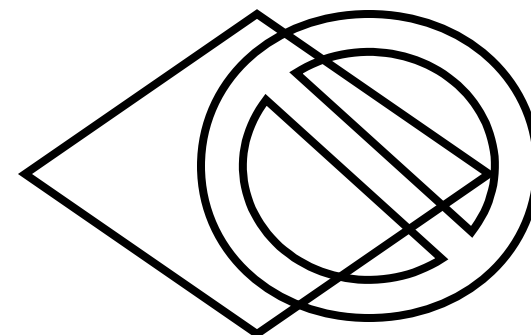
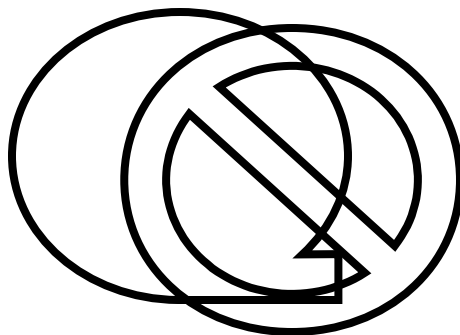
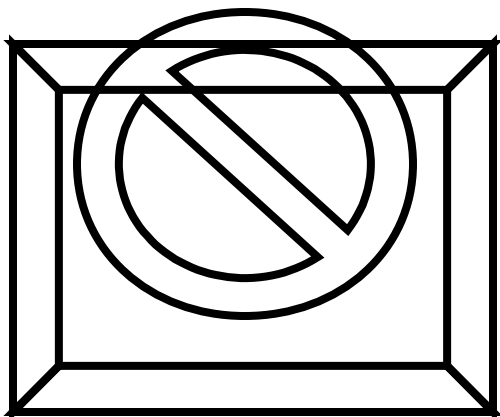
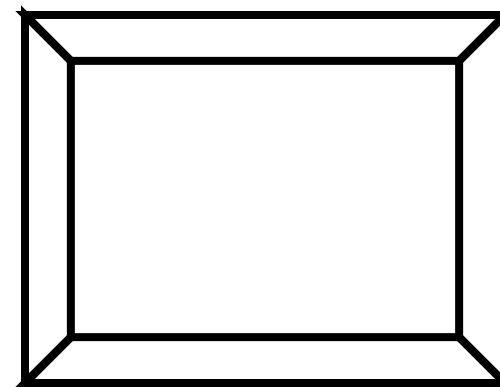
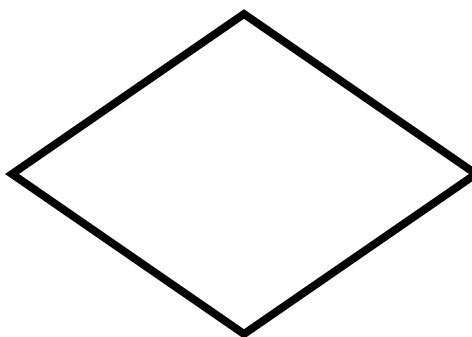
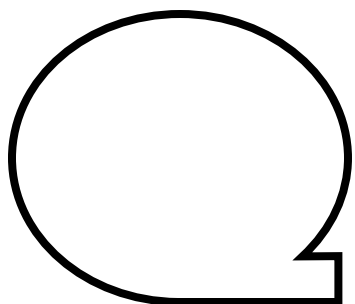

### ASSOCIAZIONI LOGICHE

Far associare le immagini secondo un legame logico.



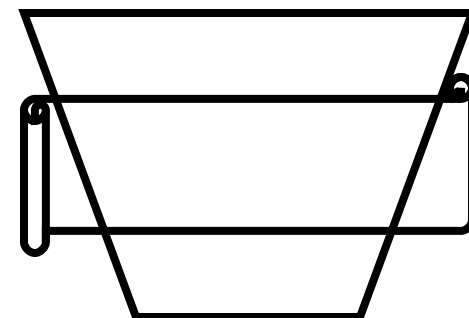
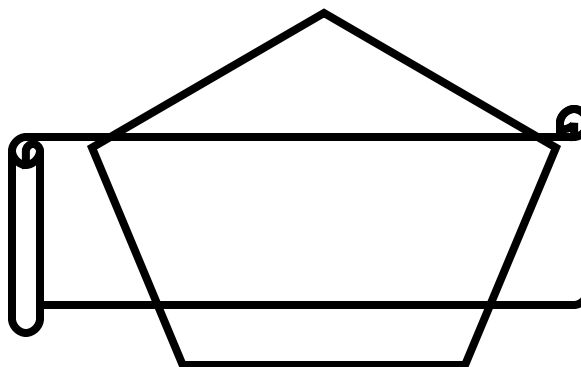
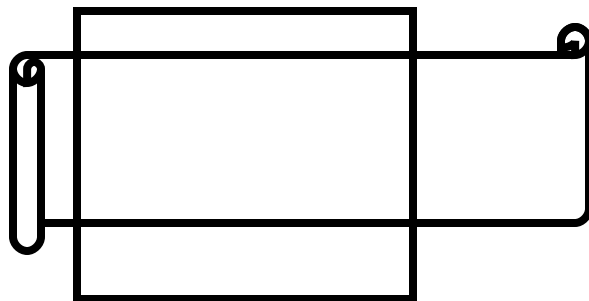
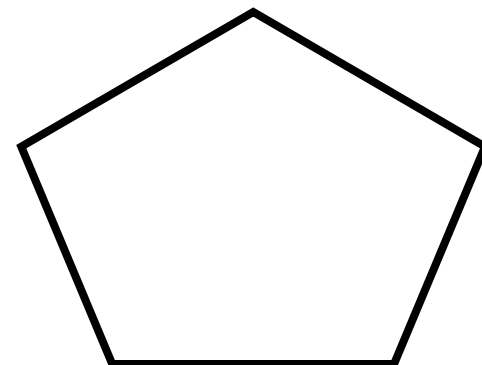
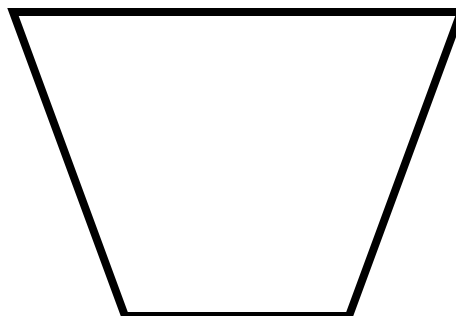
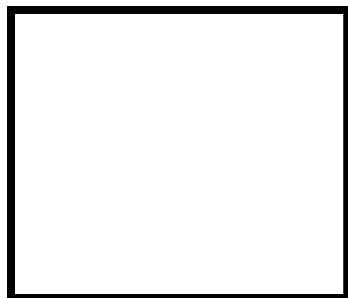

### ASSOCIAZIONI LOGICHE

Far associare le immagine secondo un legame logico.

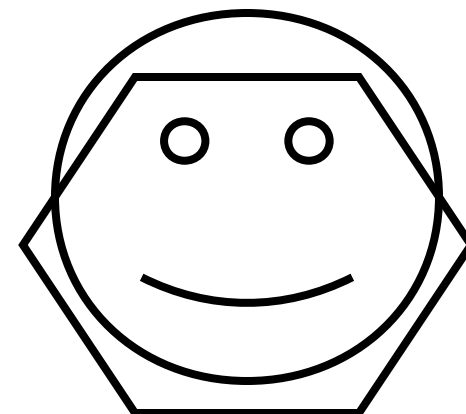
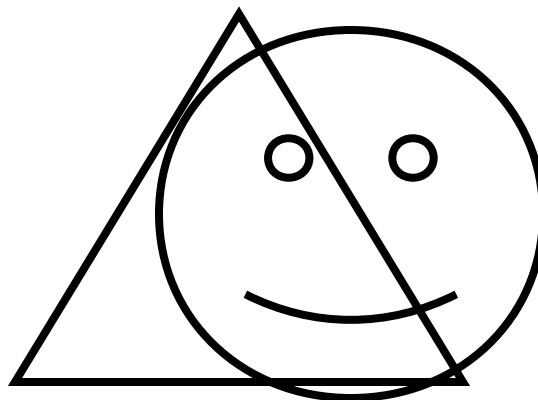
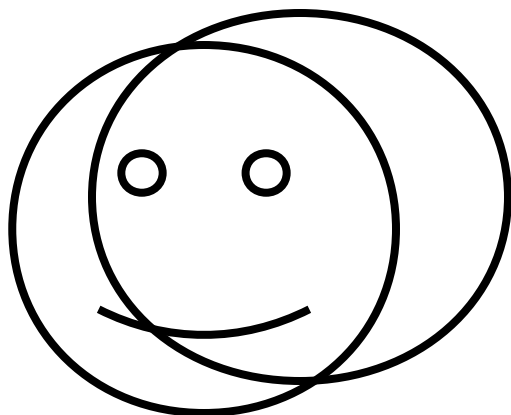
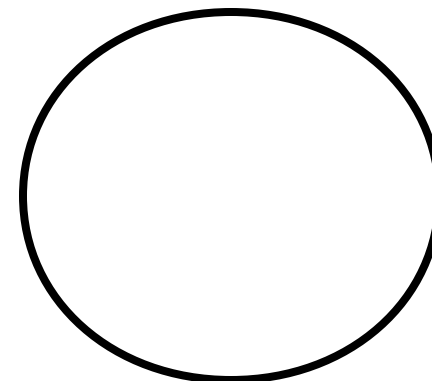
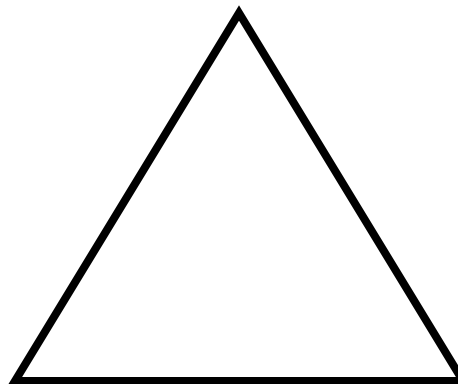
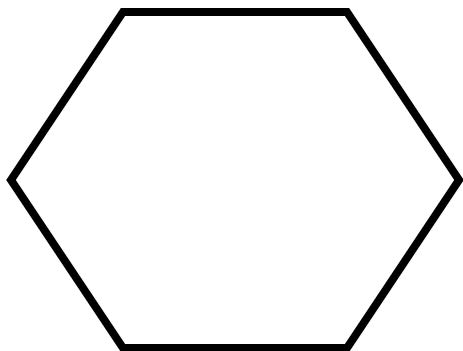

### ASSOCIAZIONI LOGICHE

Far associare le immagine secondo un legame logico.

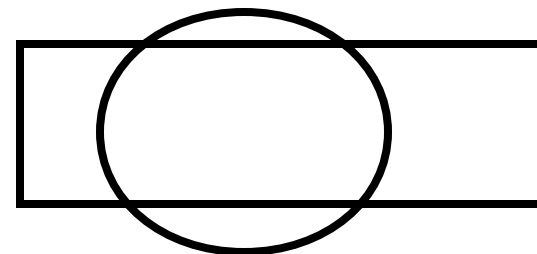
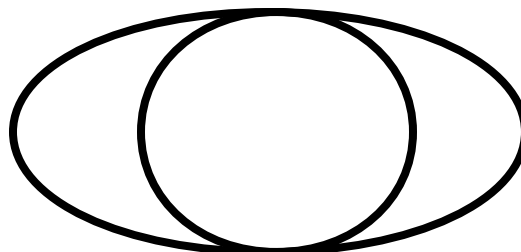
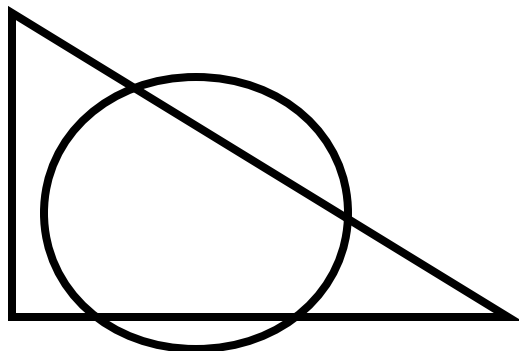
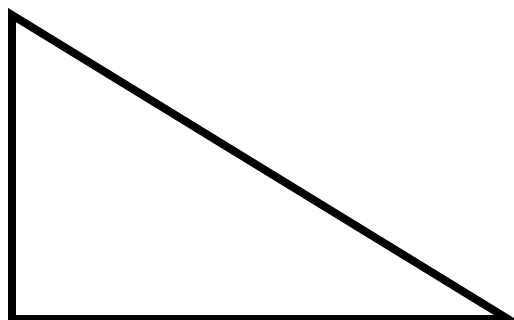
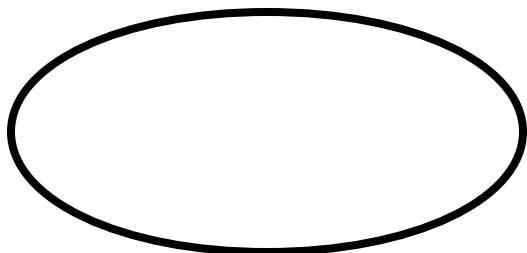

## ASSOCIAZIONI LOGICHE

Far associare le immagine secondo un legame logico.

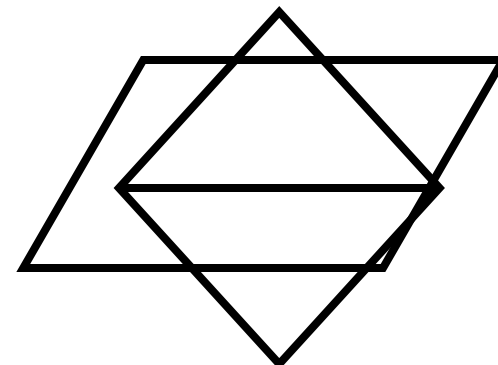
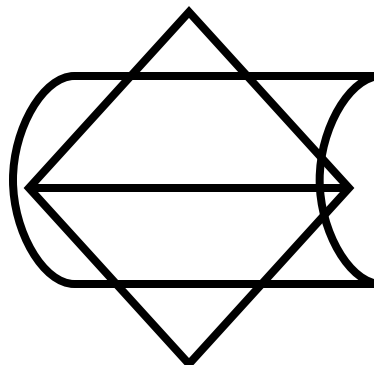
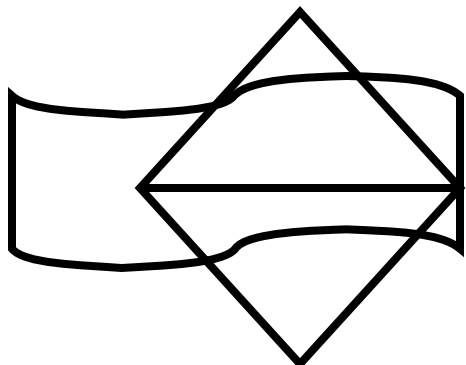
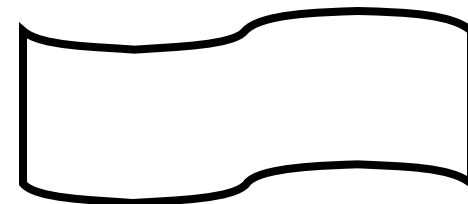
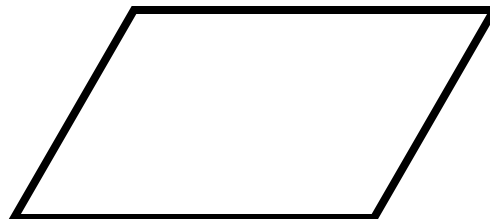
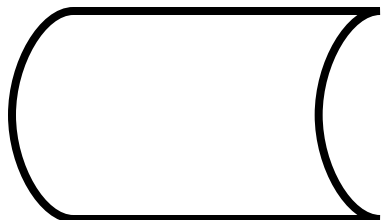

### ASSOCIAZIONI LOGICHE

Far associare le immagine secondo un legame logico.

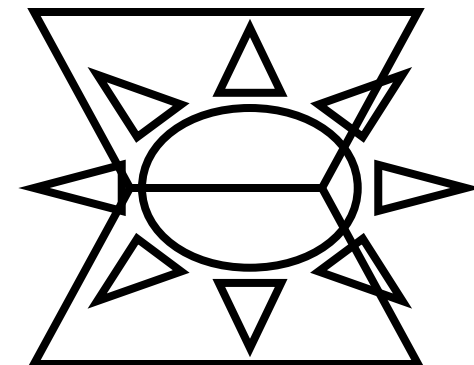
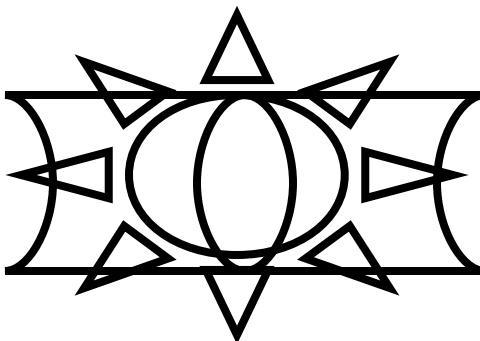
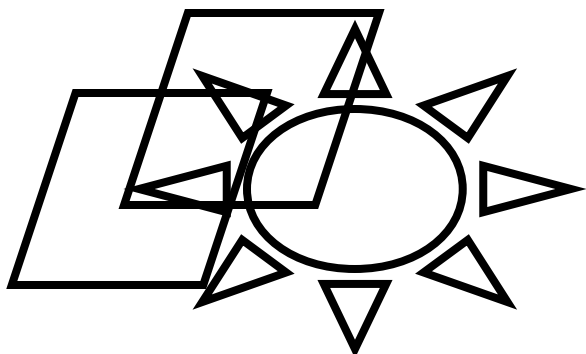
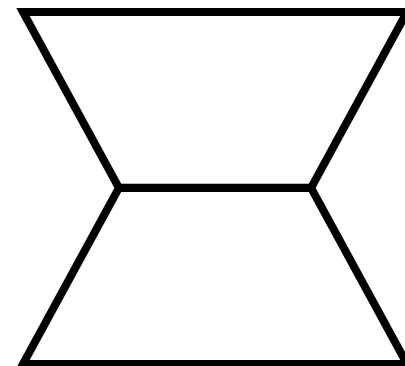
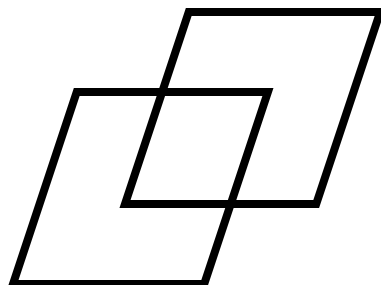
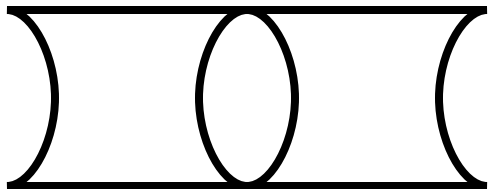

### ASSOCIAZIONI LOGICHE

Far associare le immagine secondo un legame logico.

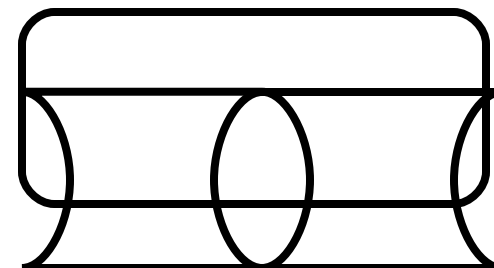
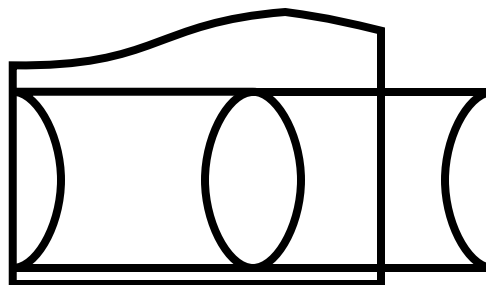
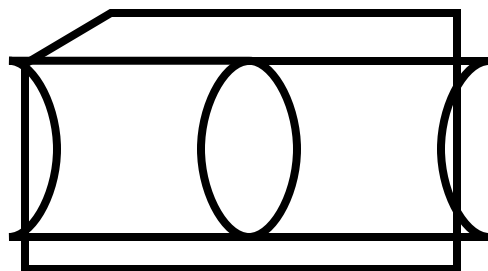
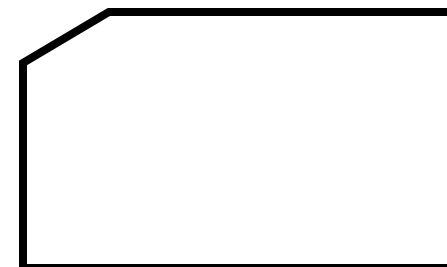
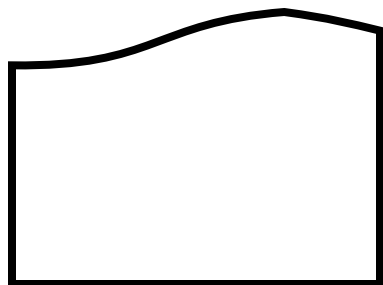

## ASSOCIAZIONI LOGICHE

Far associare le immagine secondo un legame logico.

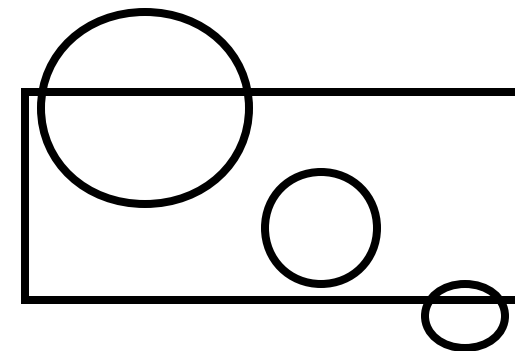
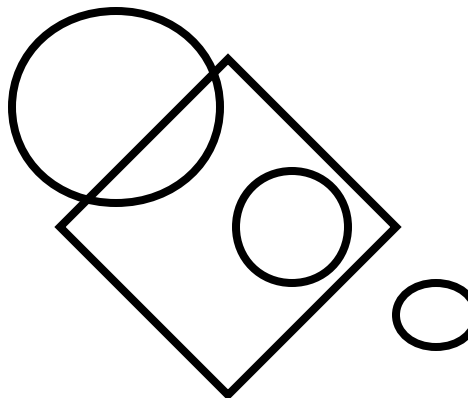
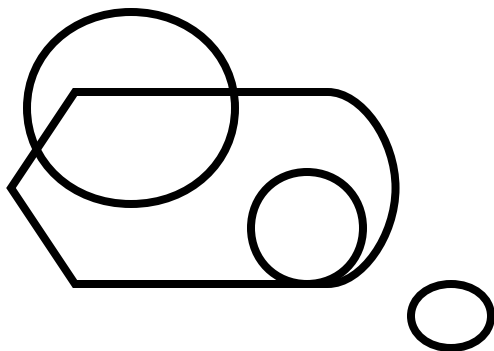
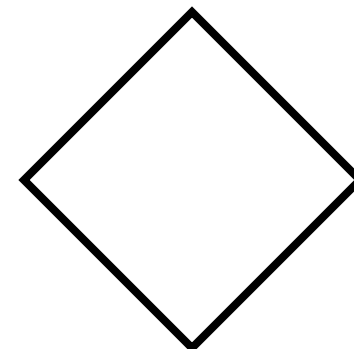
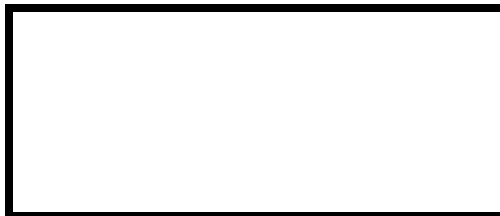

### ASSOCIAZIONI LOGICHE

Far associare le immagine secondo un legame logico.

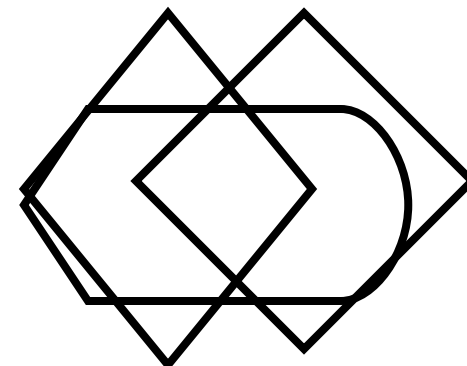
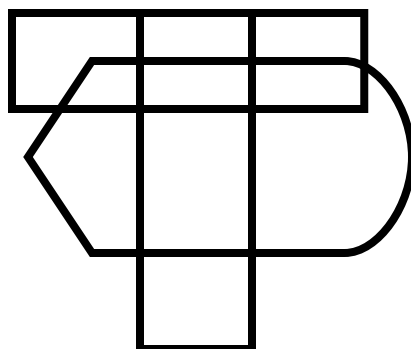
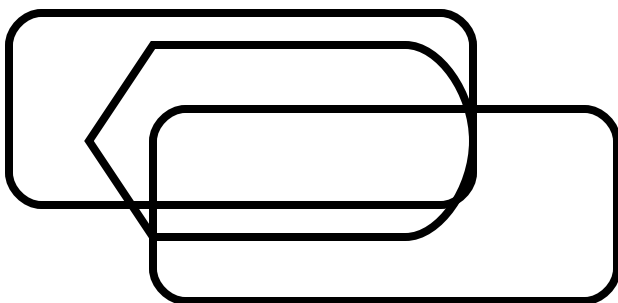
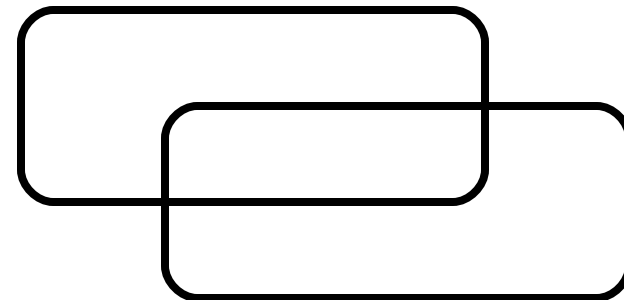
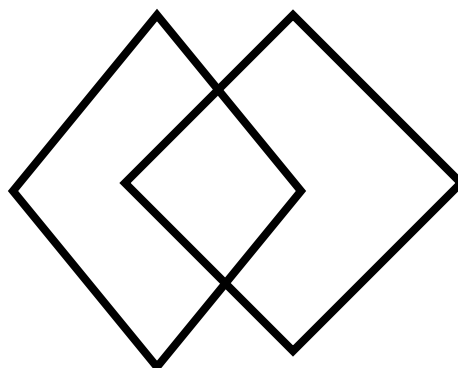
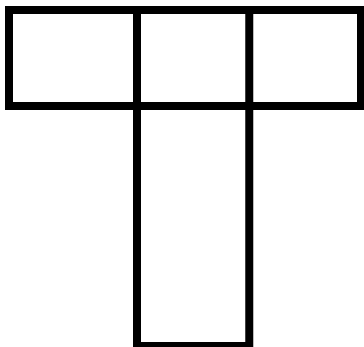

### ASSOCIAZIONI LOGICHE

Far associare le immagine secondo un legame logico.



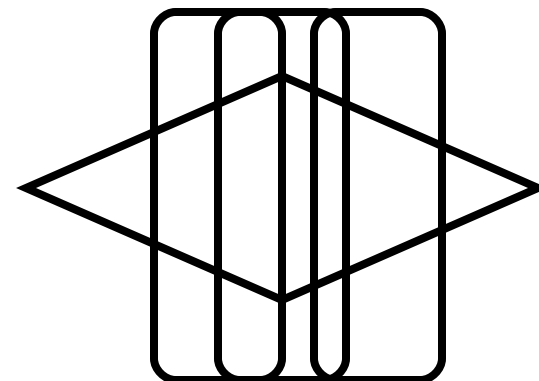
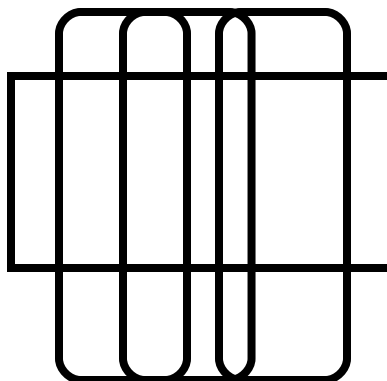
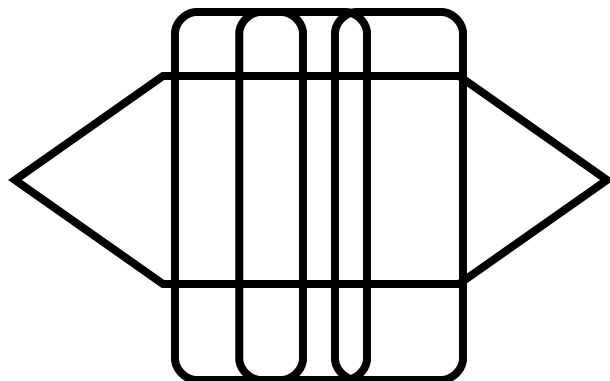
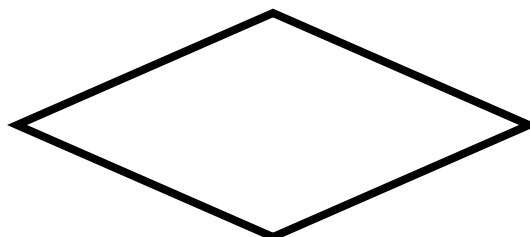
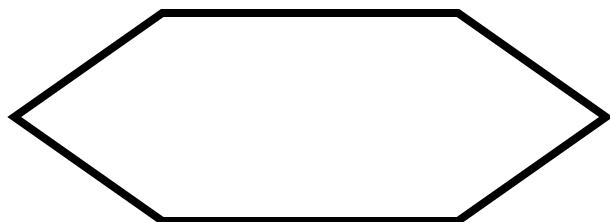

### ASSOCIAZIONI LOGICHE

Far associare le immagine secondo un legame logico.

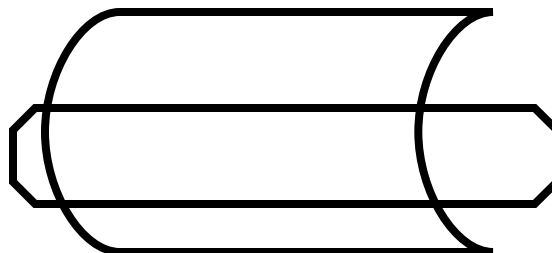
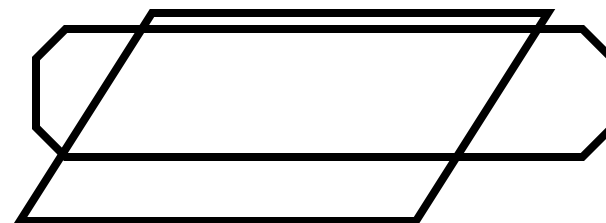
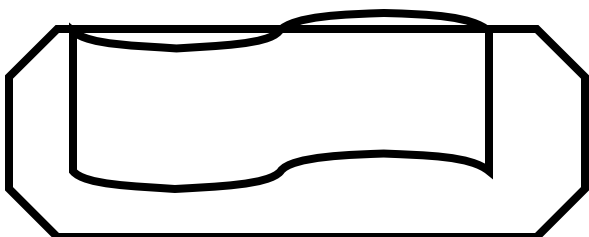
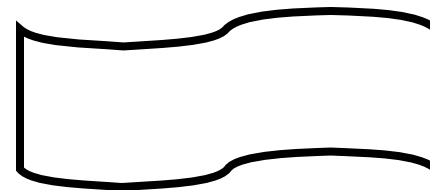
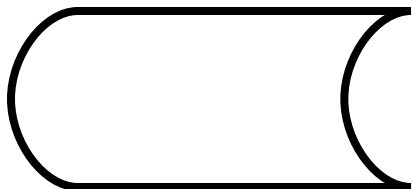

## ASSOCIAZIONI LOGICHE

Far associare le immagine secondo un legame logico.

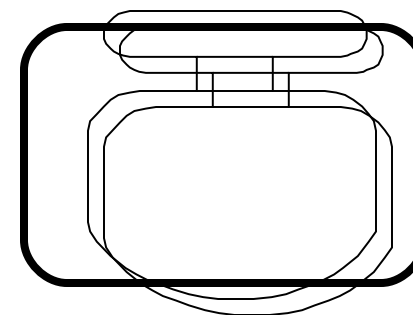
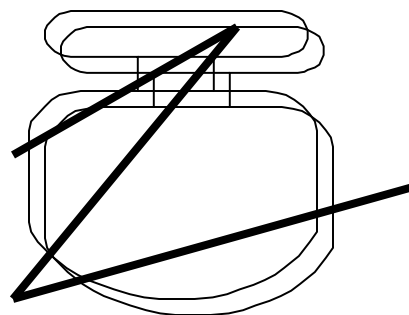
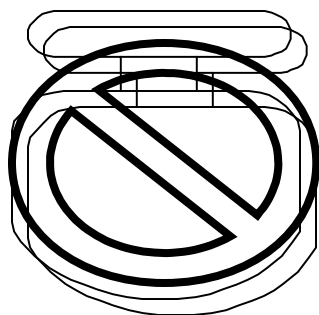
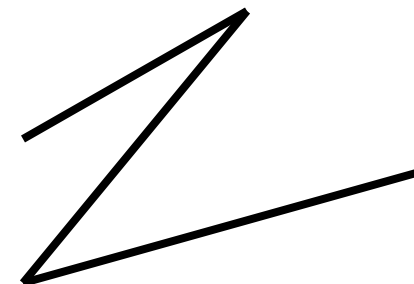
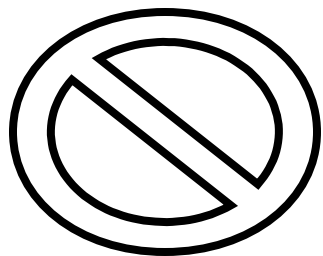

## ASSOCIAZIONI LOGICHE

Far associare le immagine secondo un legame logico.

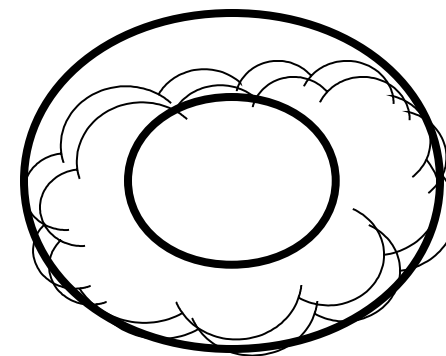
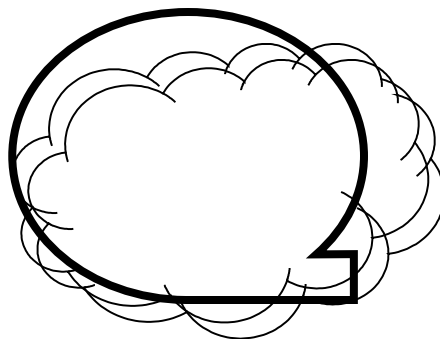
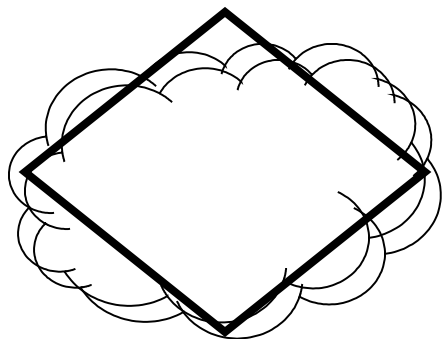
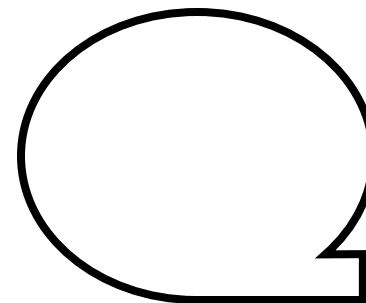
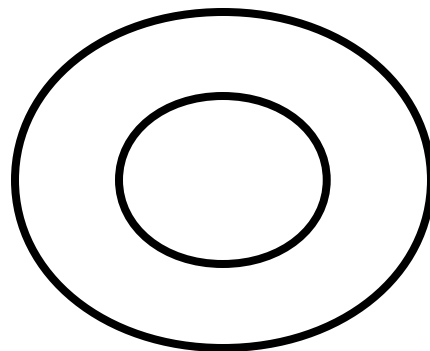
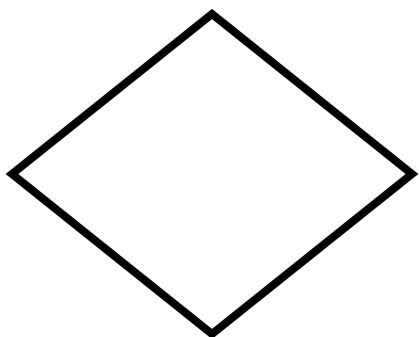

## ASSOCIAZIONI LOGICHE

Far associare le immagine secondo un legame logico.

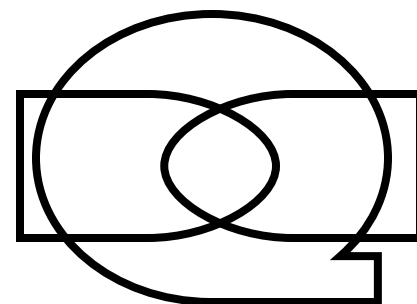
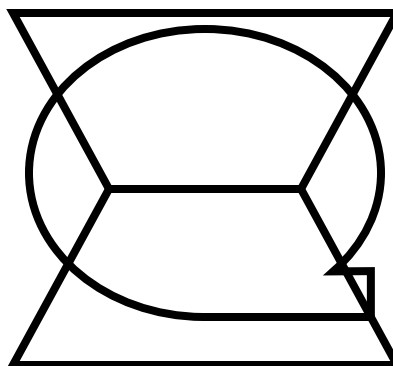
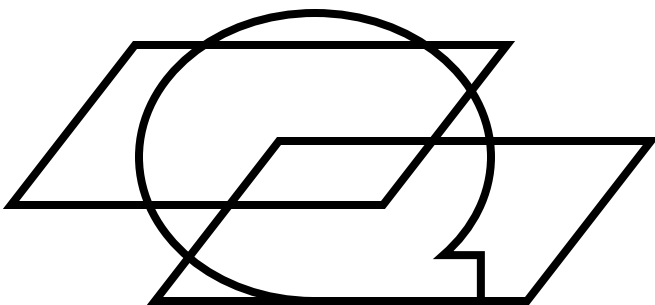
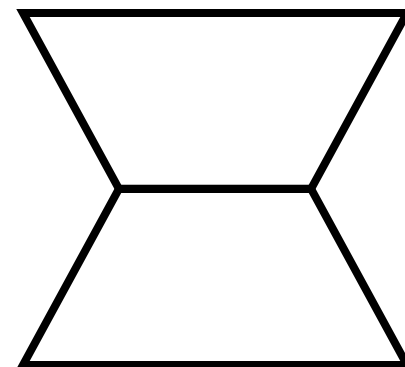
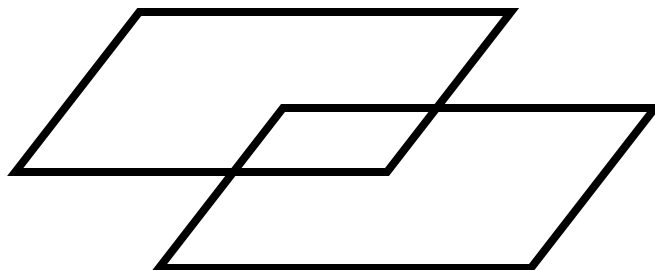
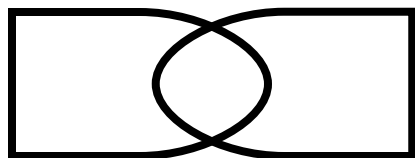

### ASSOCIAZIONI LOGICHE

Far associare le immagine secondo un legame logico.

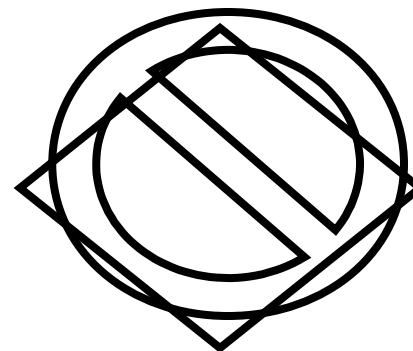
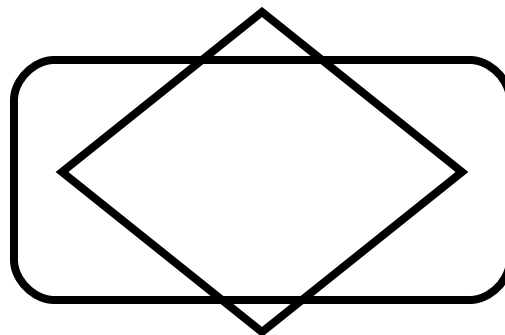
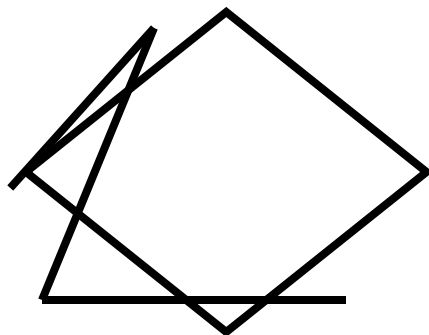
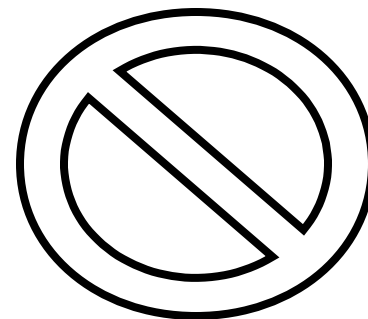
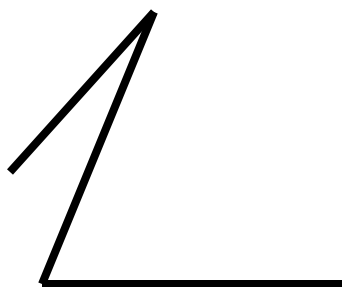

### ASSOCIAZIONI LOGICHE

Far associare le immagine secondo un legame logico.

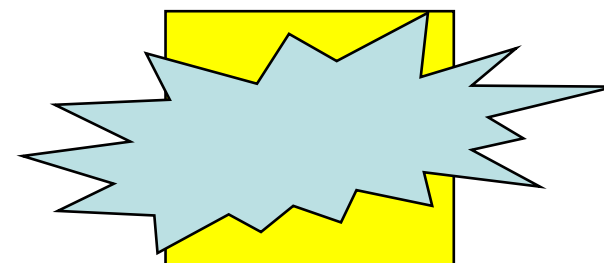
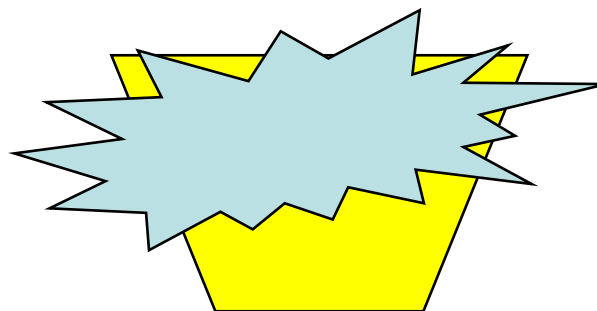
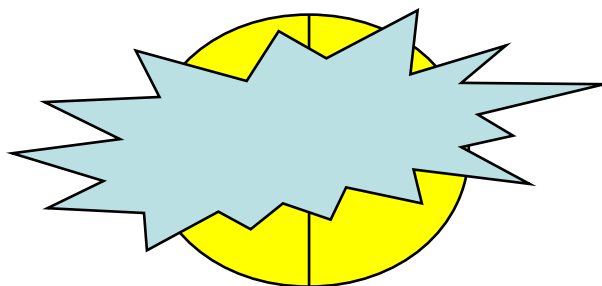
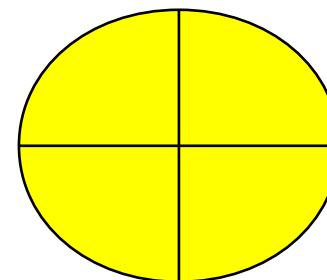
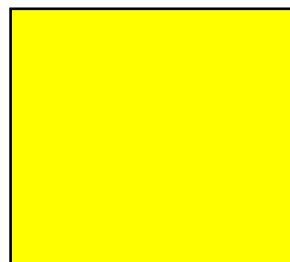
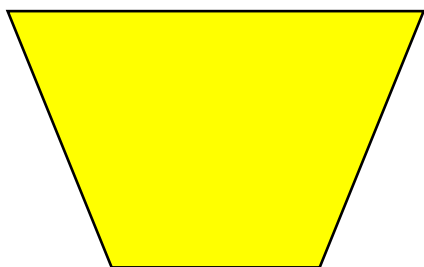

### ASSOCIAZIONI LOGICHE

Far associare le immagine secondo un legame logico.

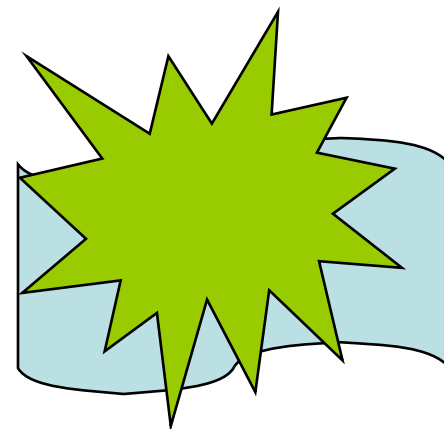
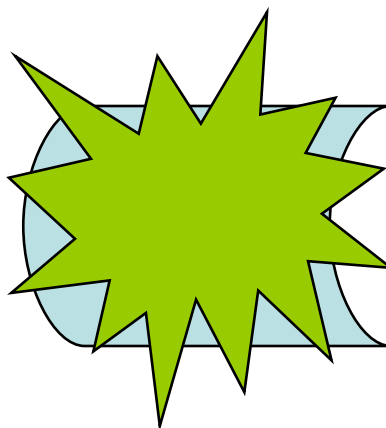
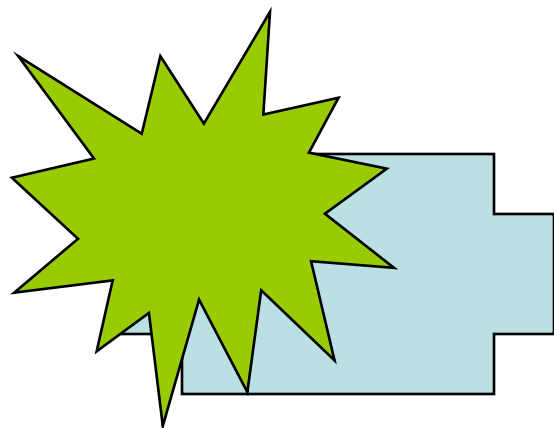
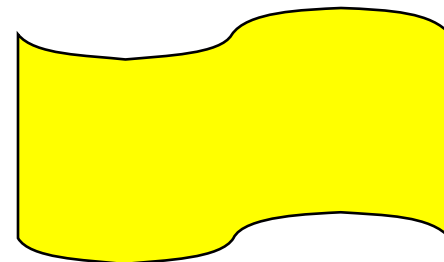
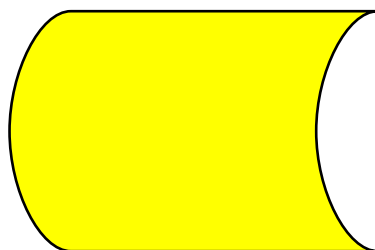
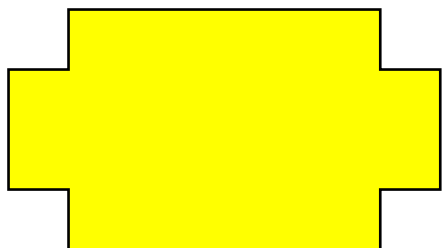

### ASSOCIAZIONI LOGICHE

Far associare le immagine secondo un legame logico.



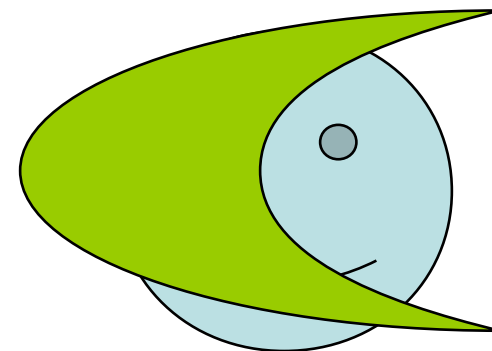
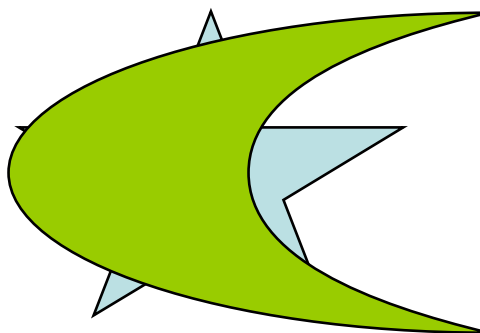
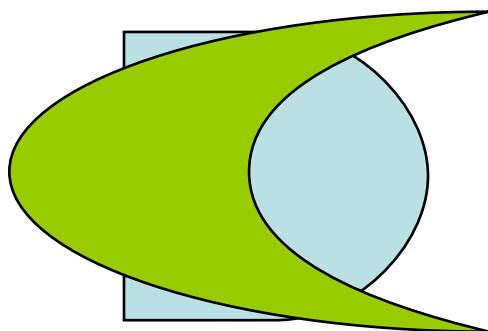
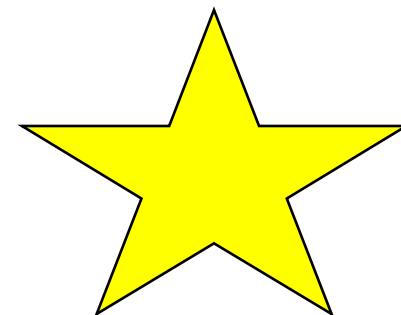
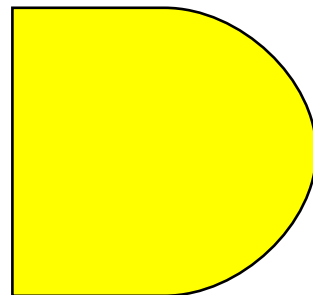
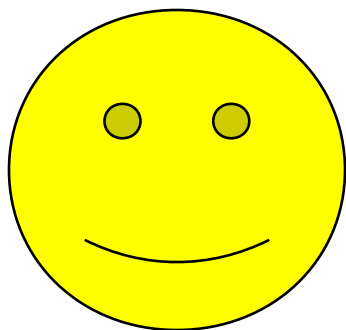

### ASSOCIAZIONI LOGICHE

Far associare le immagine secondo un legame logico.

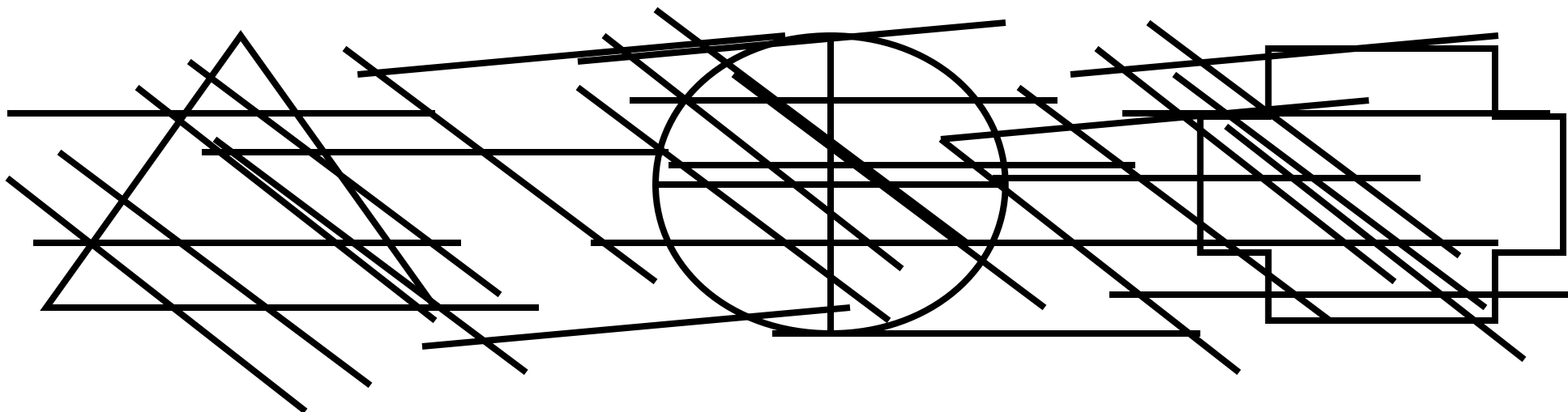
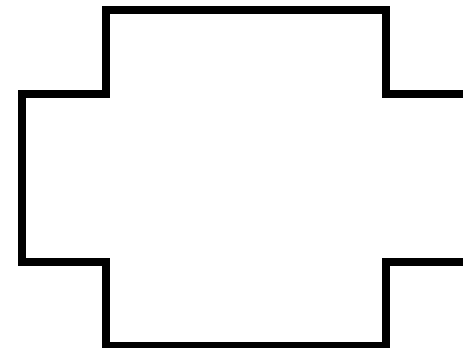
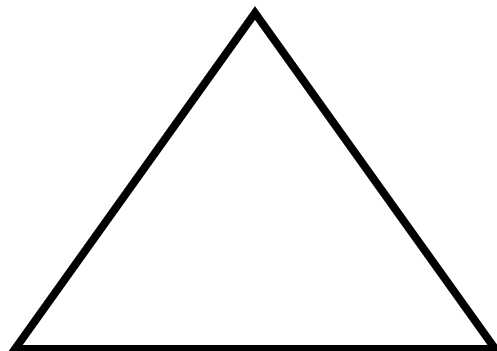
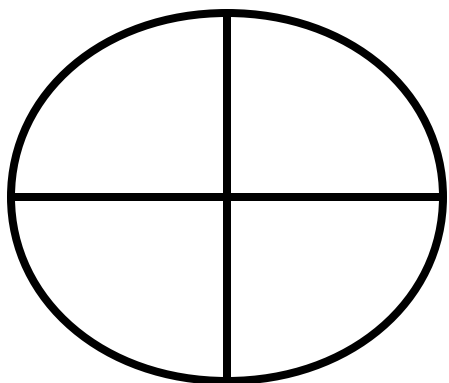

## ASSOCIAZIONI LOGICHE

Far associare le immagine secondo un legame logico.

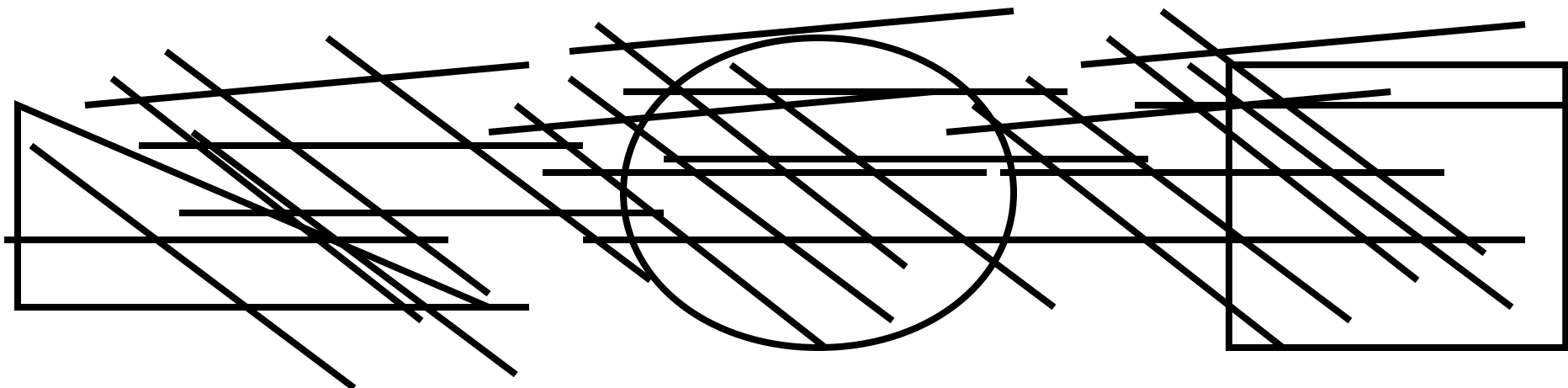
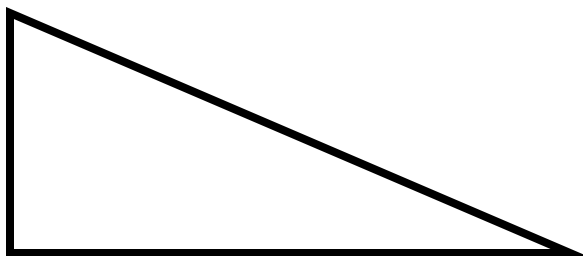
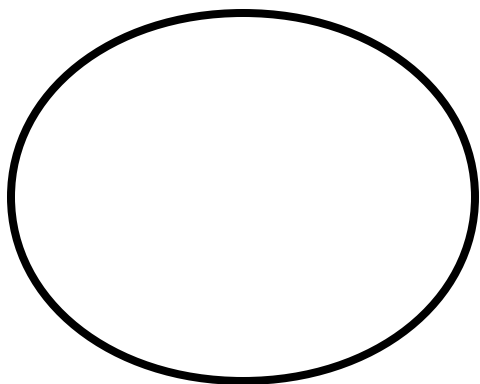

## ASSOCIAZIONI LOGICHE

Far associare le immagine secondo un legame logico.

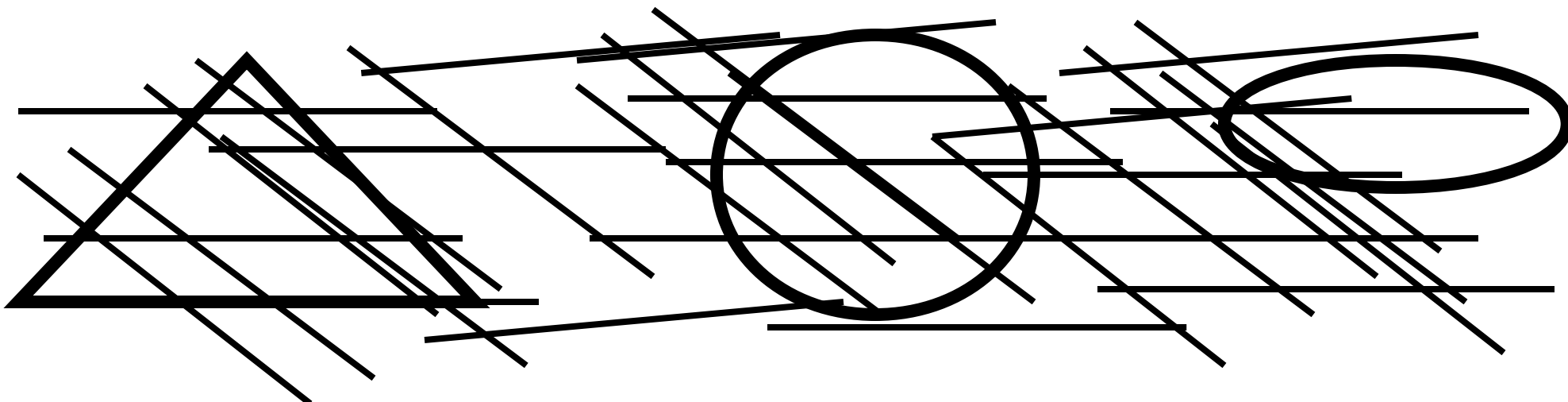
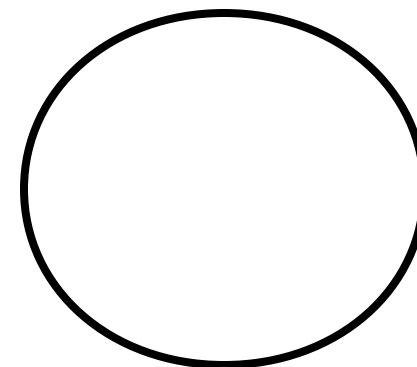
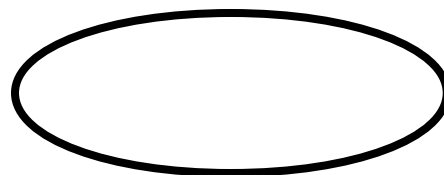
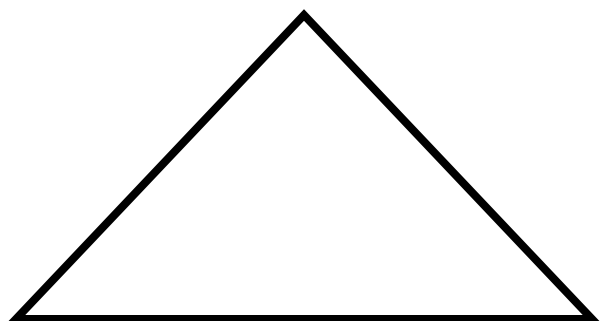

## ASSOCIAZIONI LOGICHE

Far associare le immagine secondo un legame logico.

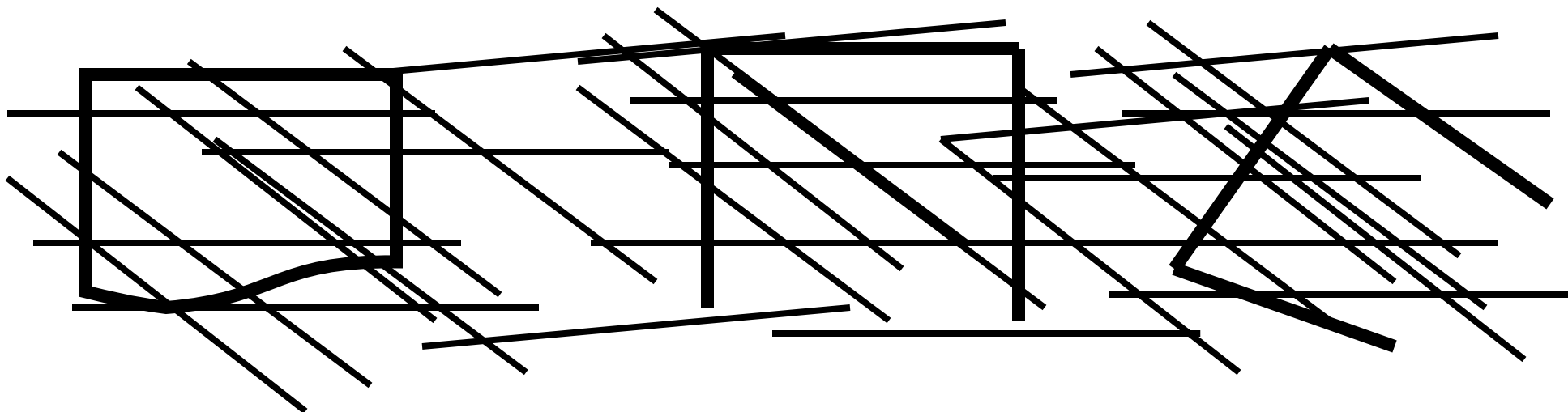
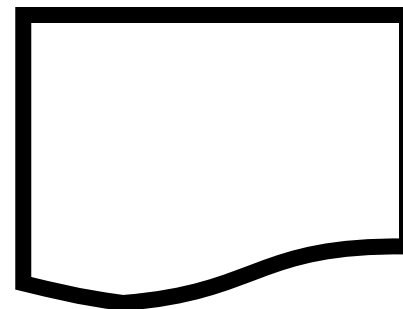
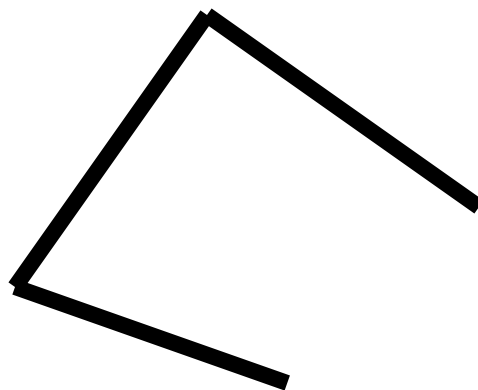

## ASSOCIAZIONI LOGICHE

Far associare le immagine secondo un legame logico.

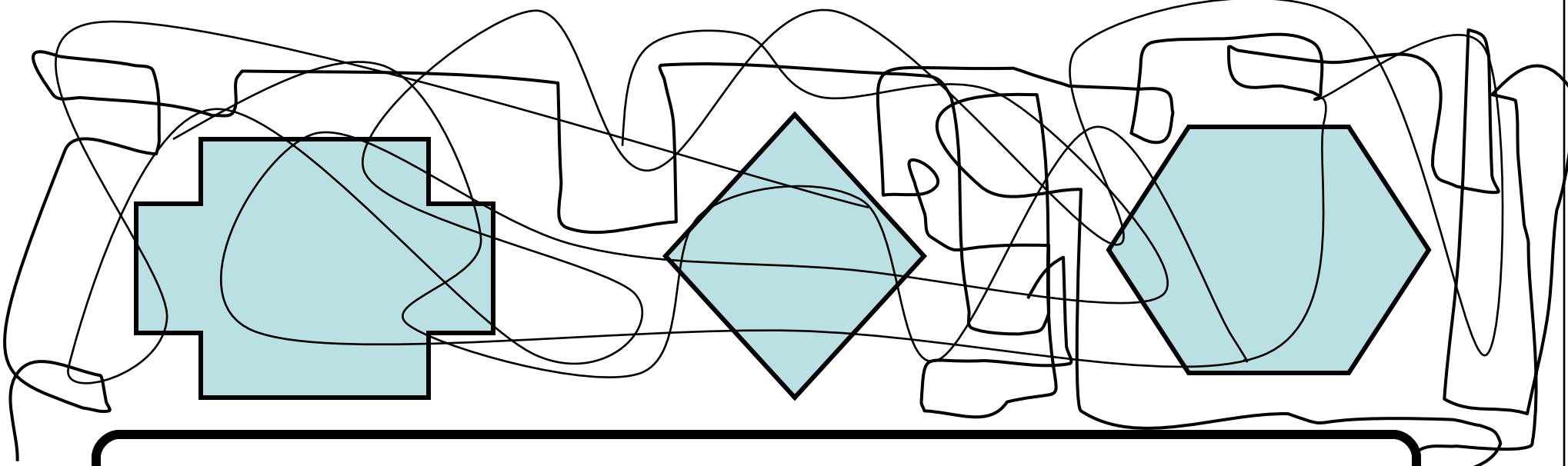
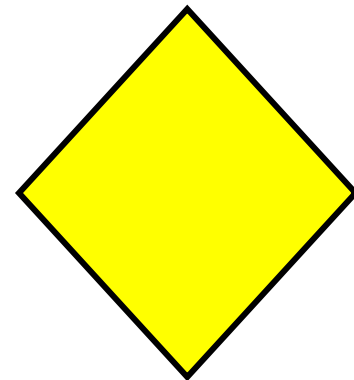
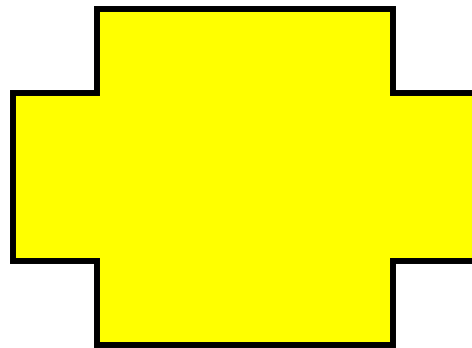
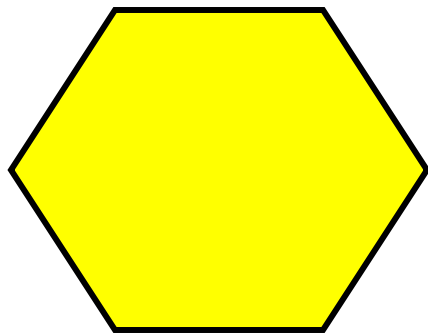

ASSOCIAZIONI LOGICHE

Far associare le immagine secondo un legame logico.

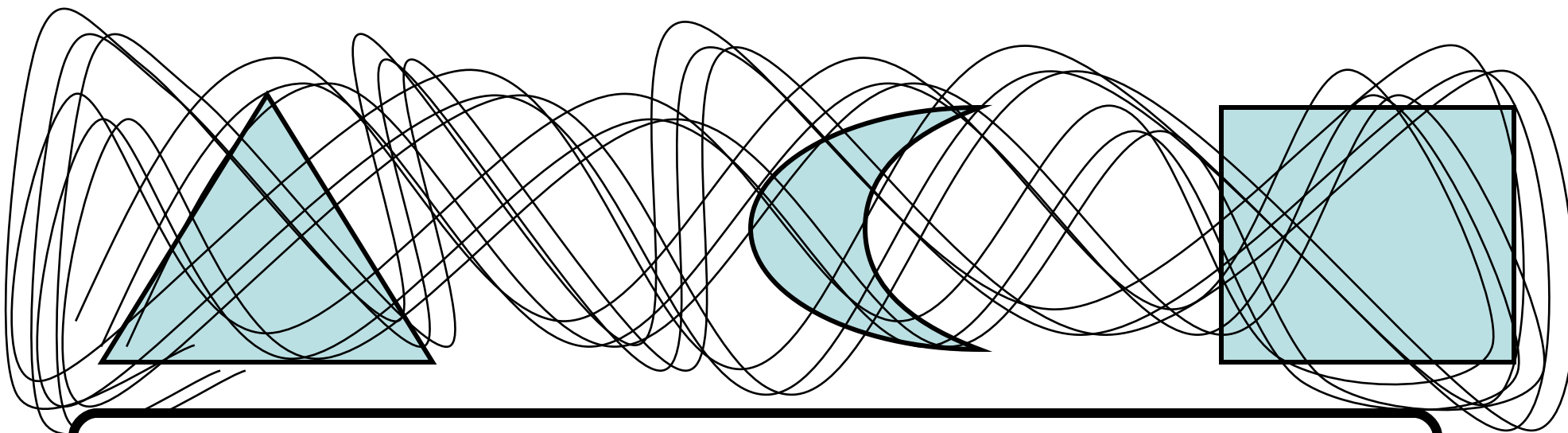
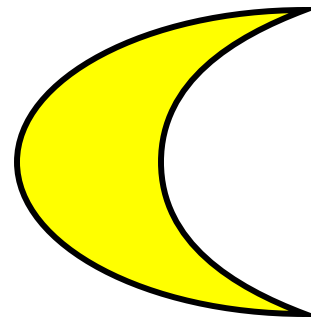
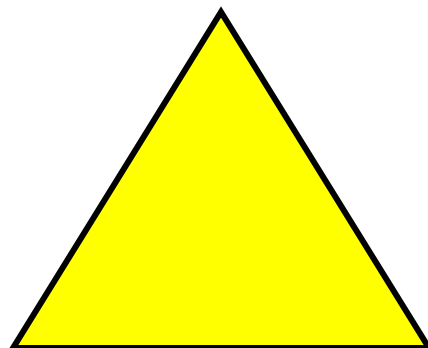
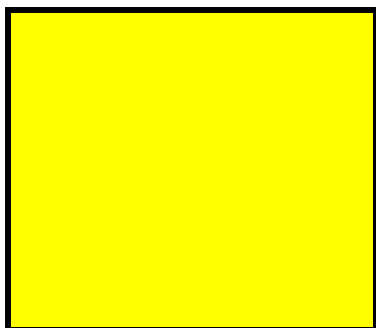

### ASSOCIAZIONI LOGICHE

Far associare le immagine secondo un legame logico.

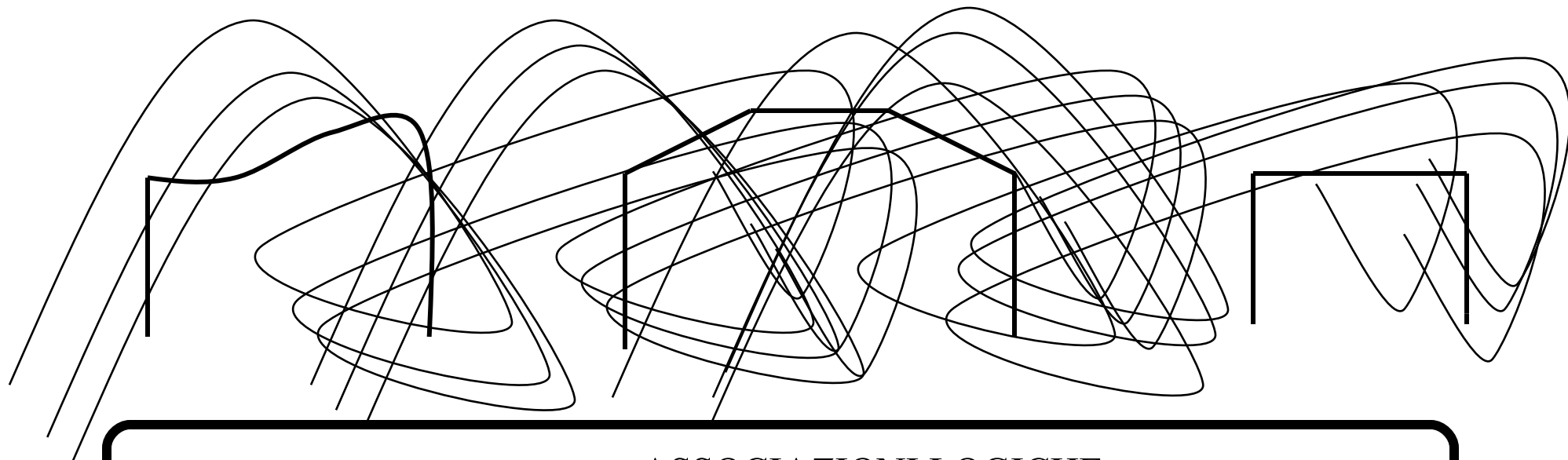
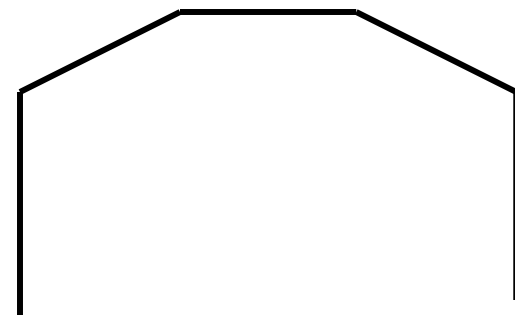
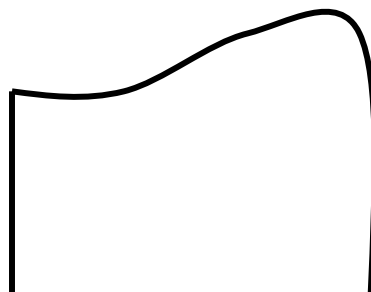

ASSOCIAZIONI LOGICHE

Far associare le immagine secondo un legame logico.



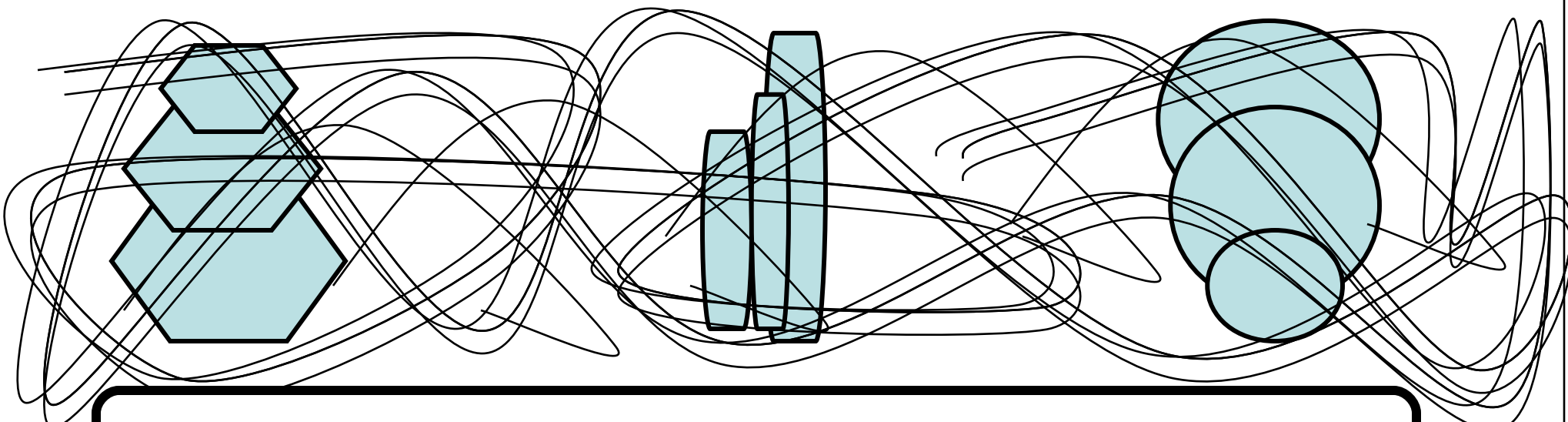
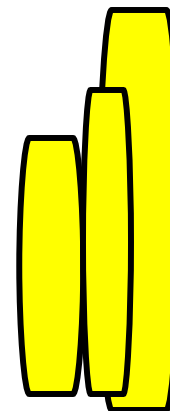
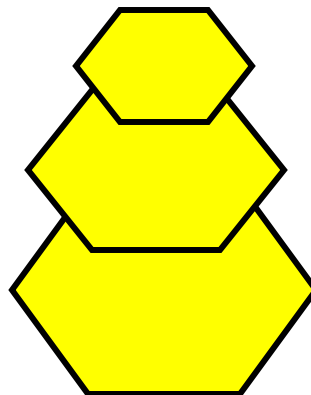
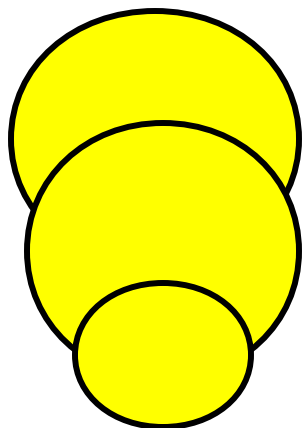

### ASSOCIAZIONI LOGICHE

Far associare le immagine secondo un legame logico.

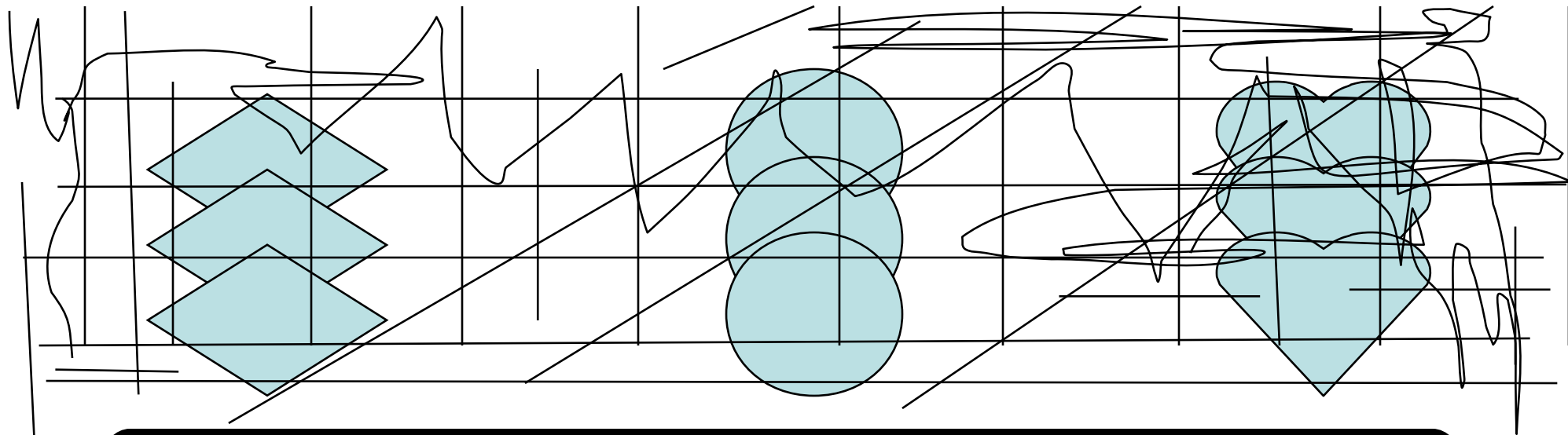
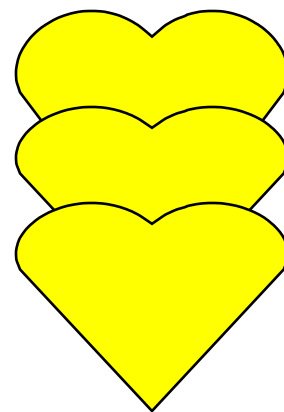
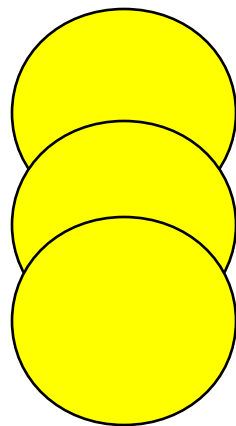
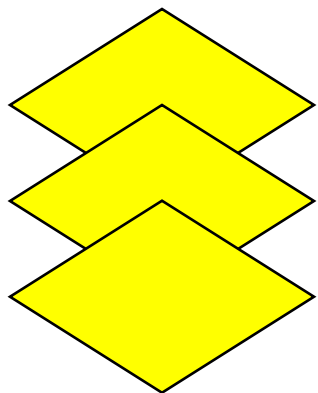

## ASSOCIAZIONI LOGICHE

Far associare le immagine secondo un legame logico.

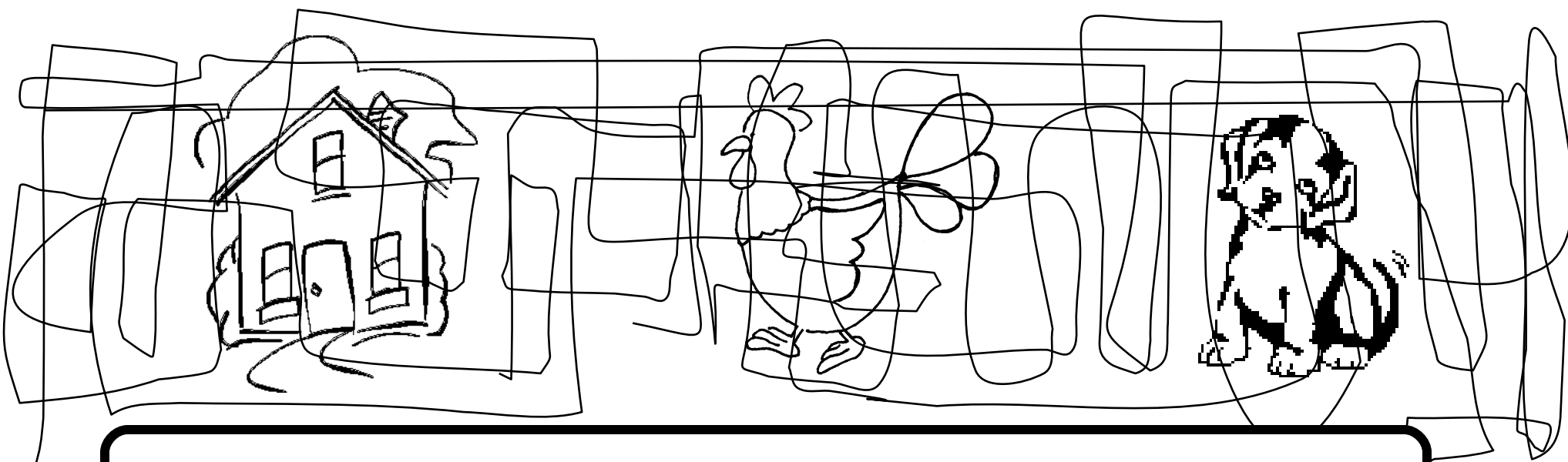
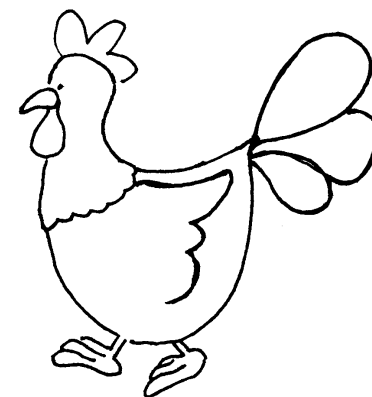

### ASSOCIAZIONI LOGICHE

Far associare le immagine secondo un legame logico.

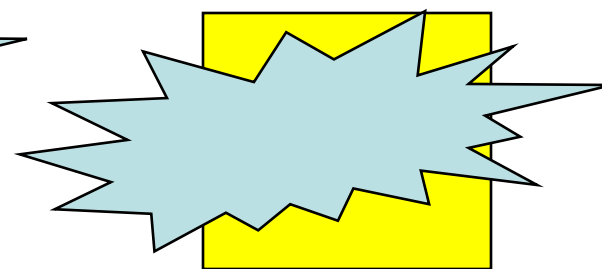
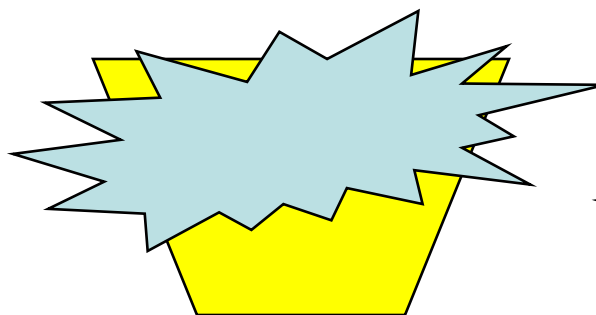
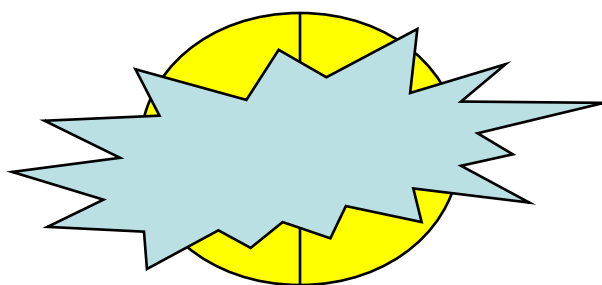
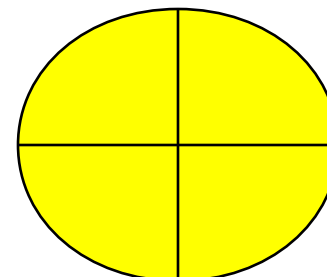
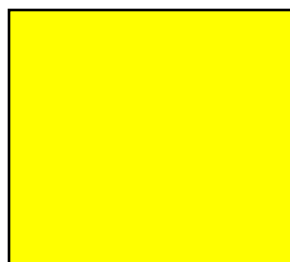
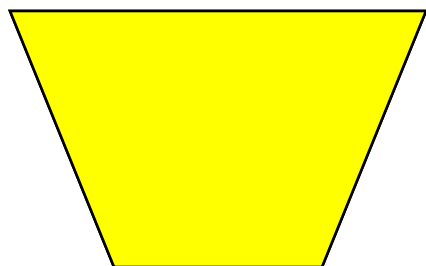

## ASSOCIAZIONI LOGICHE

Far associare le immagine secondo un legame logico.

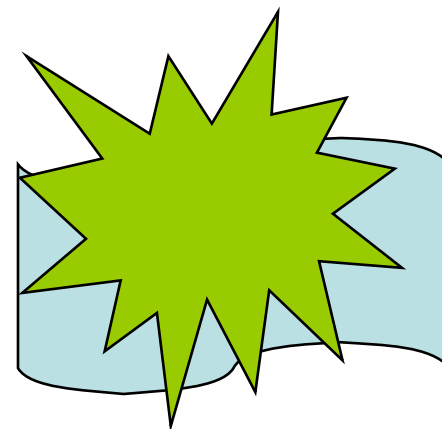
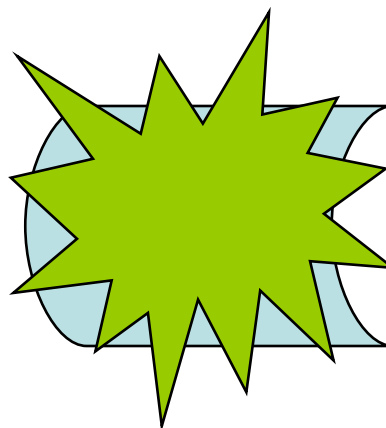
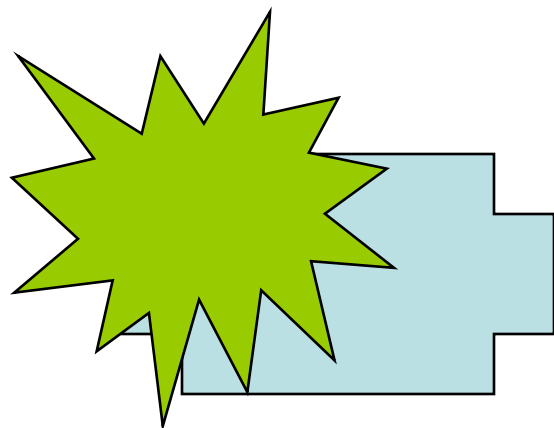
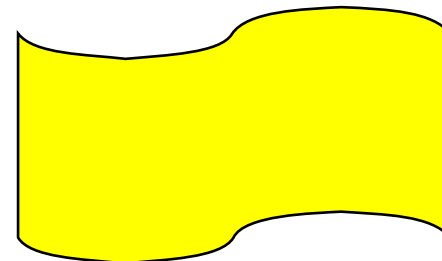
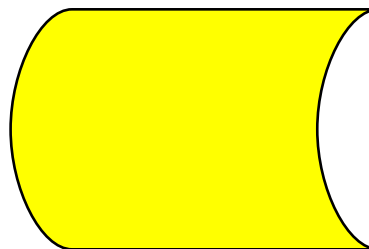
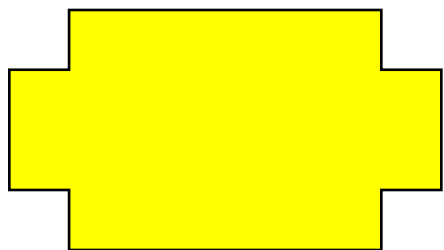

## ASSOCIAZIONI LOGICHE

Far associare le immagine secondo un legame logico.

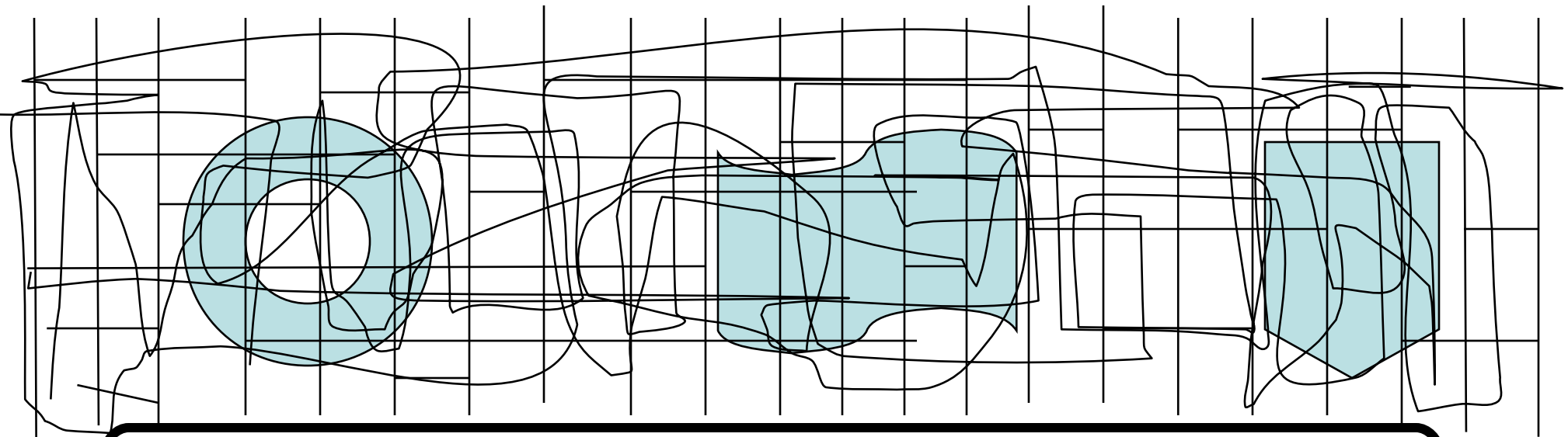
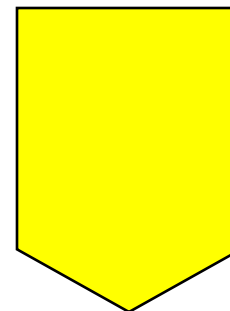
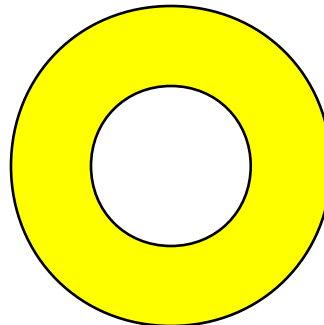
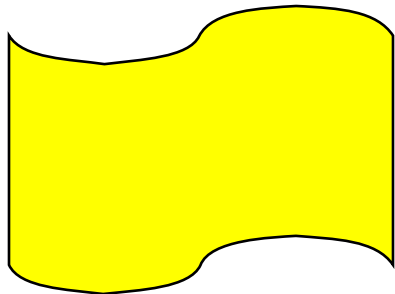

## ASSOCIAZIONI LOGICHE

Far associare le immagine secondo un legame logico.

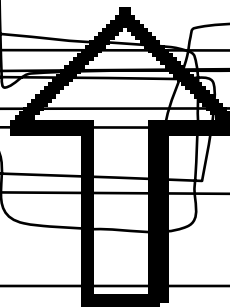
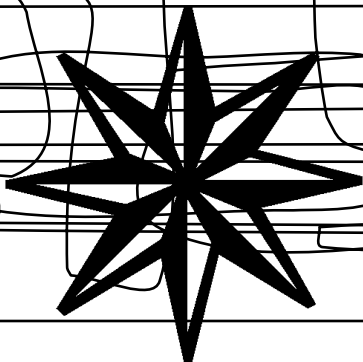
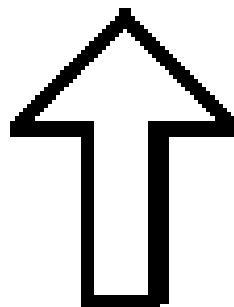
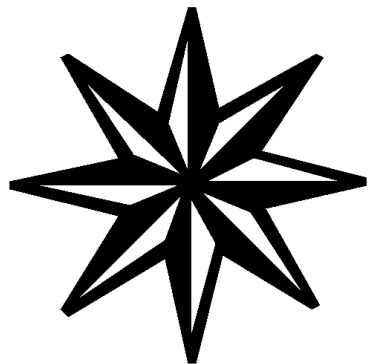

## ASSOCIAZIONI LOGICHE

Far associare le immagine secondo un legame logico.

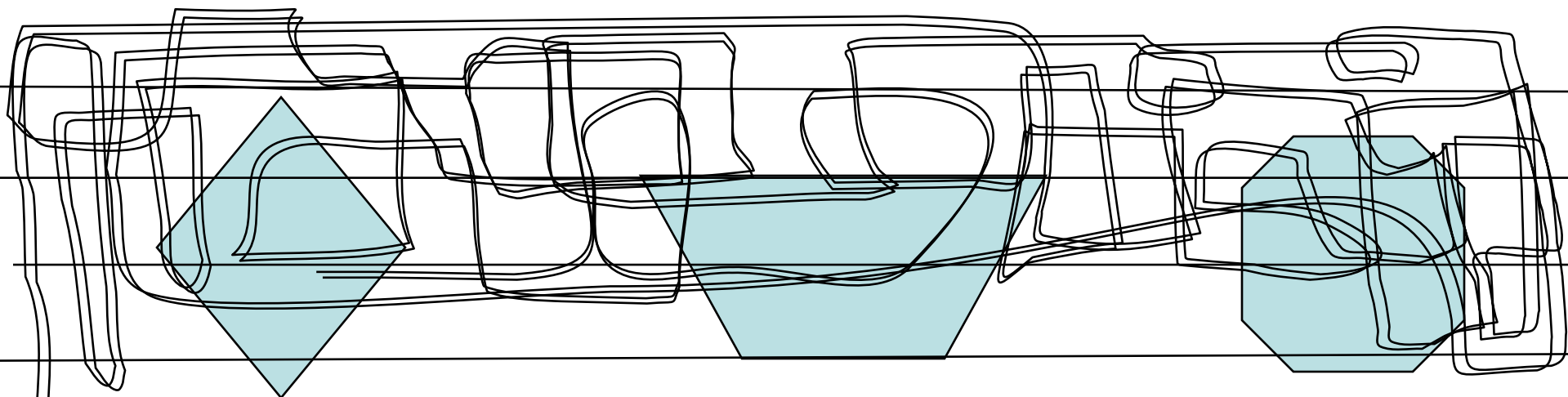
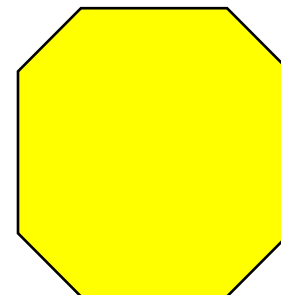
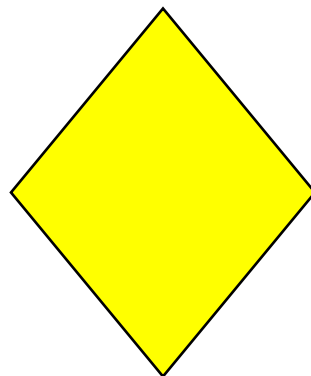
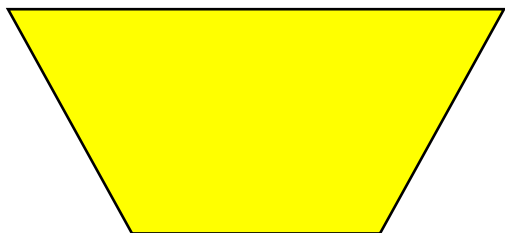

## ASSOCIAZIONI LOGICHE

Far associare le immagine secondo un legame logico.



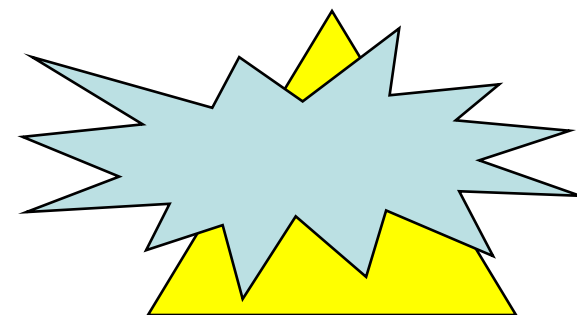
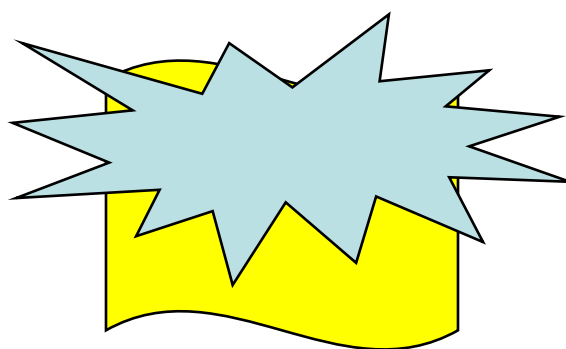
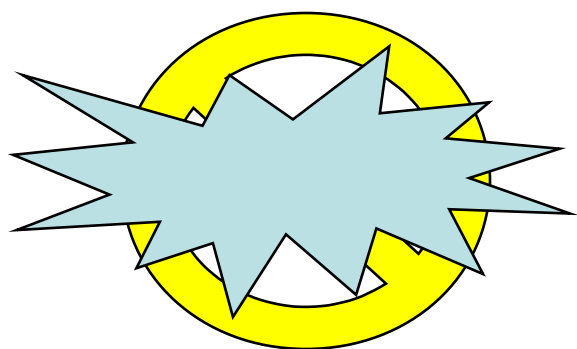
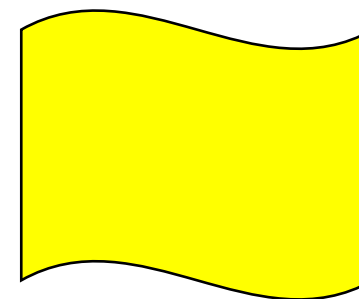
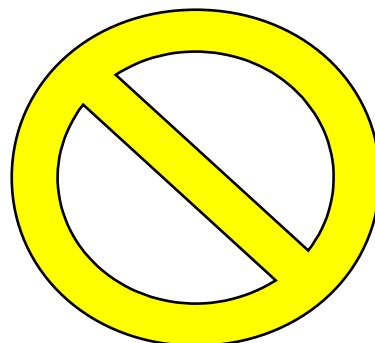
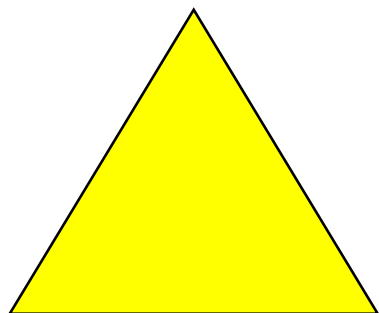

## ASSOCIAZIONI LOGICHE

Far associare le immagine secondo un legame logico.

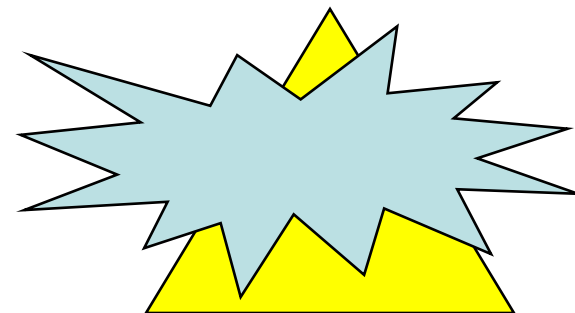
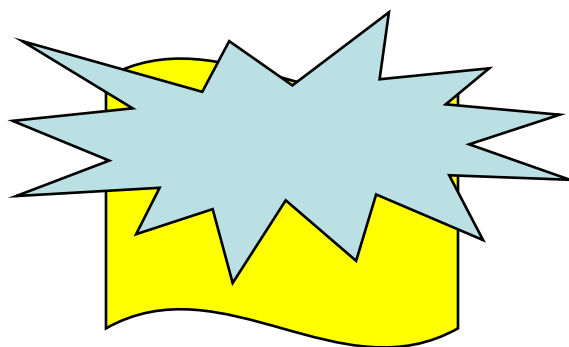
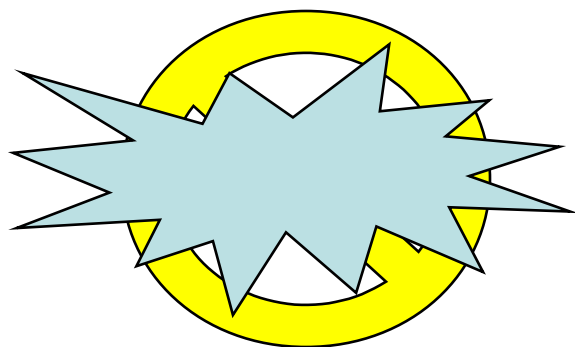
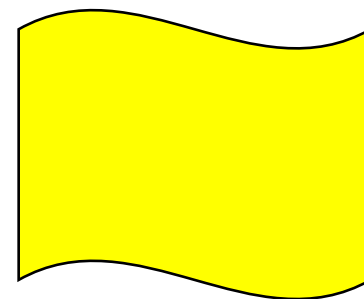
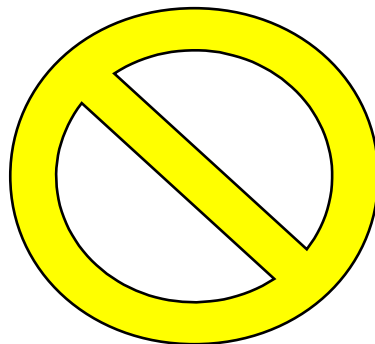
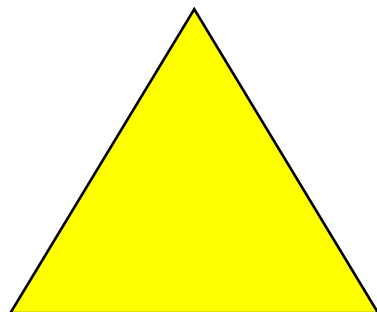

### ASSOCIAZIONI LOGICHE

Far associare le immagine secondo un legame logico.

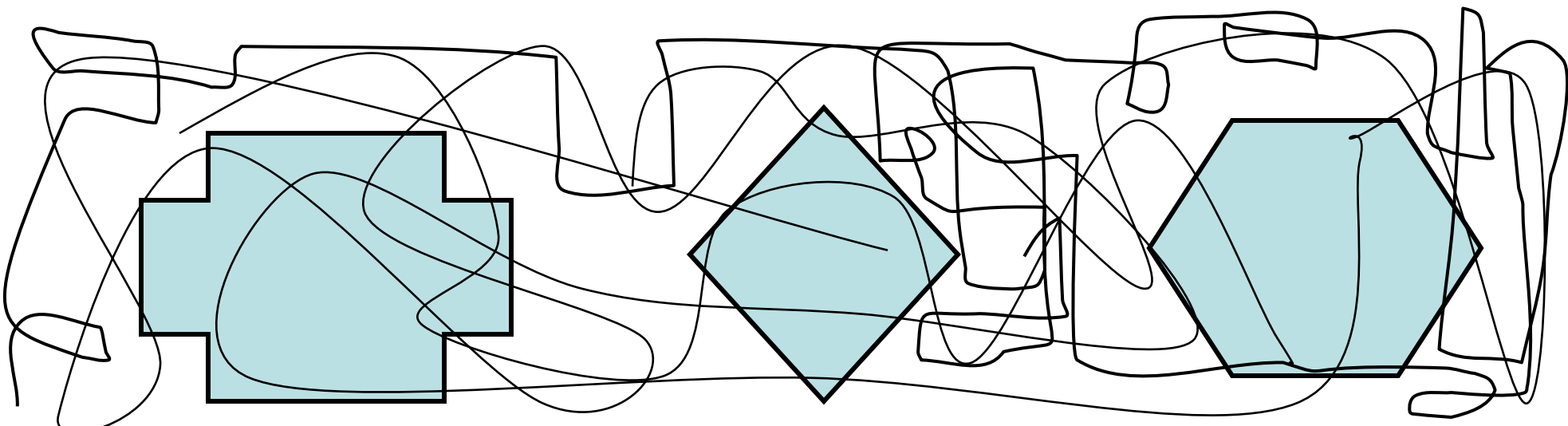
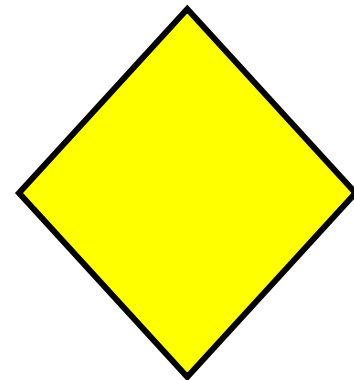
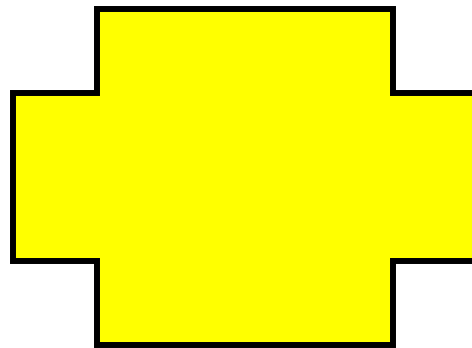
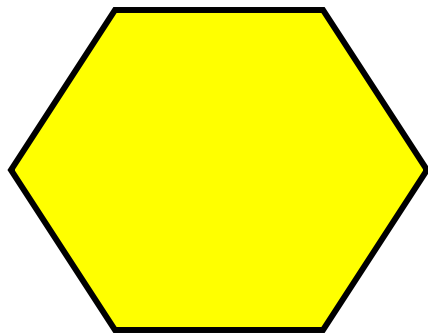

ASSOCIAZIONI LOGICHE

Far associare le immagine secondo un legame logico.

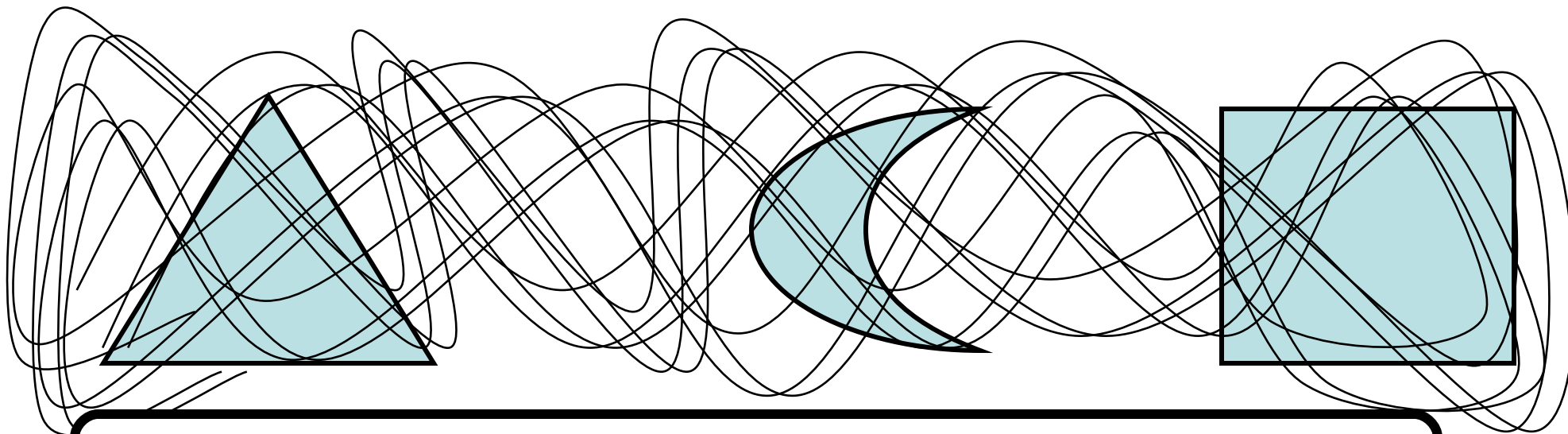
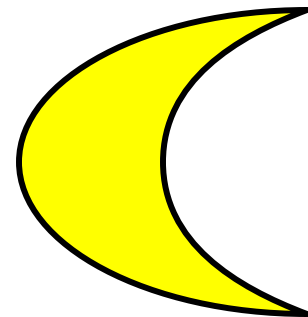
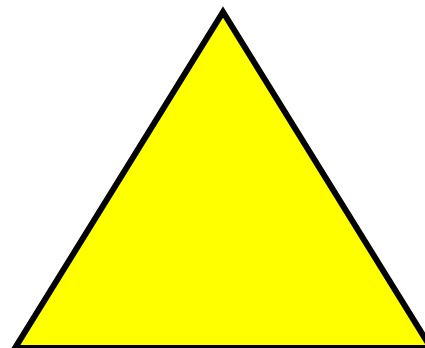
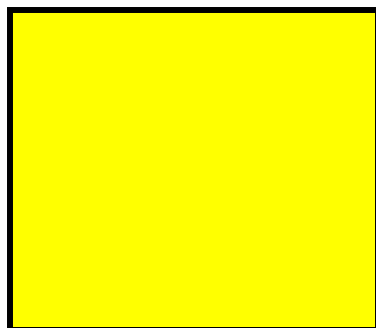

## ASSOCIAZIONI LOGICHE

Far associare le immagine secondo un legame logico.

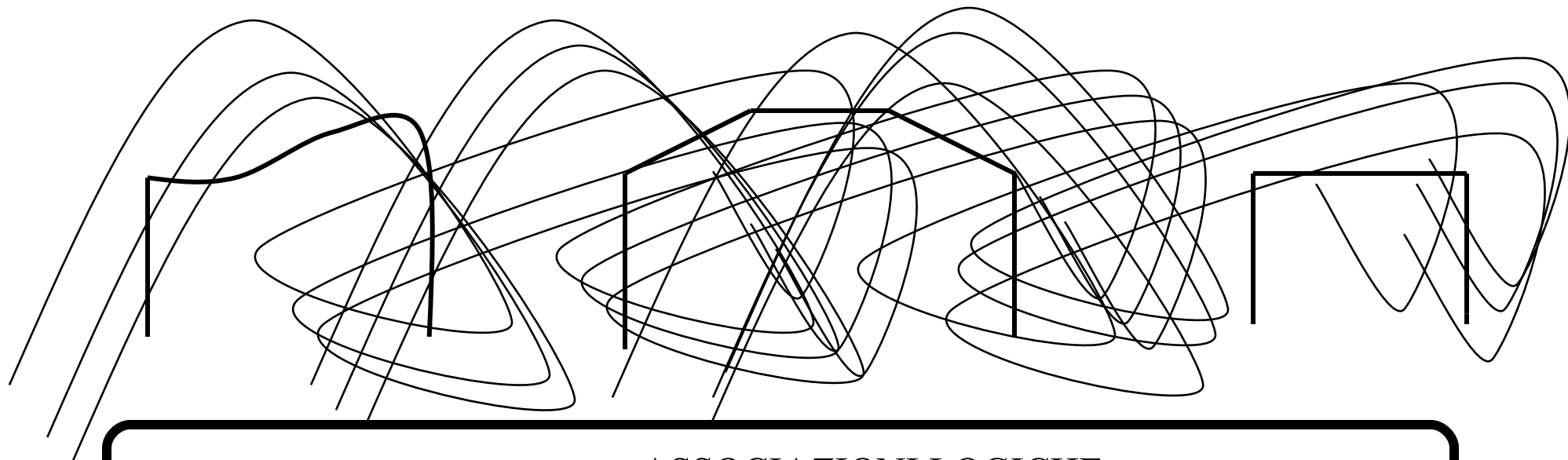
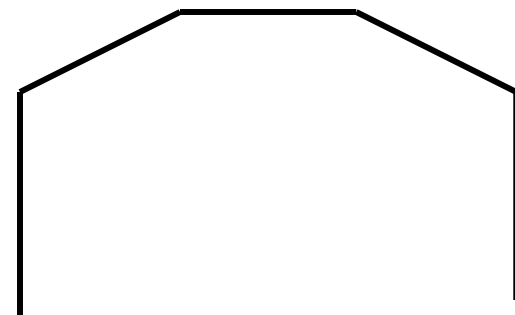
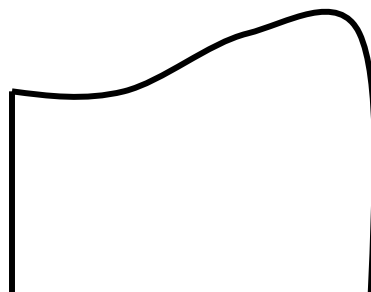

## ASSOCIAZIONI LOGICHE

Far associare le immagine secondo un legame logico.

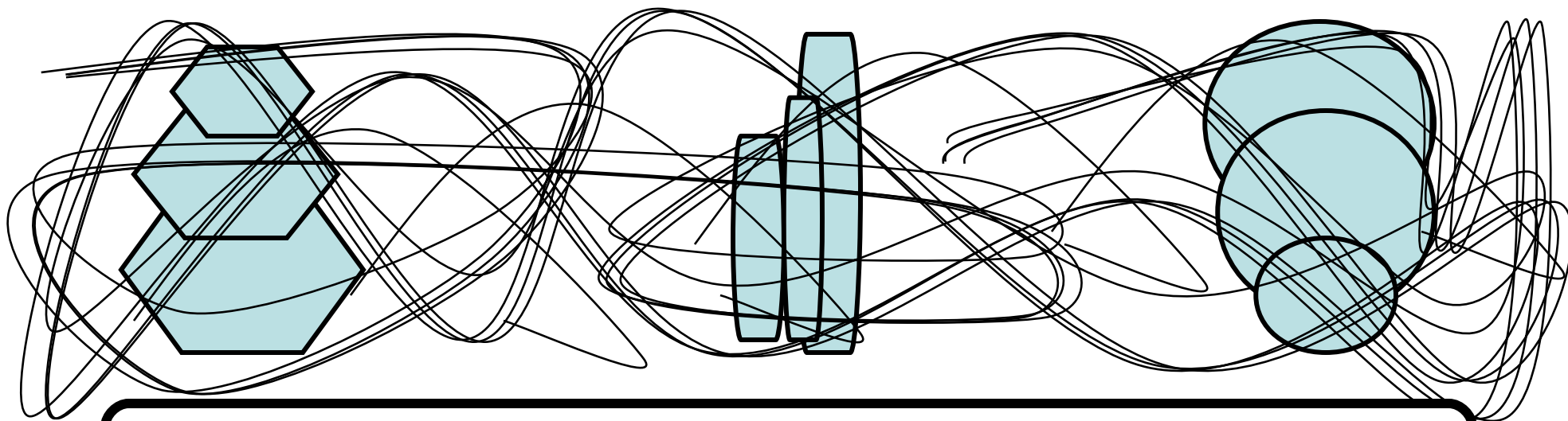
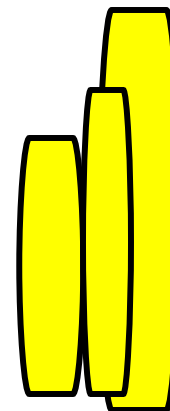
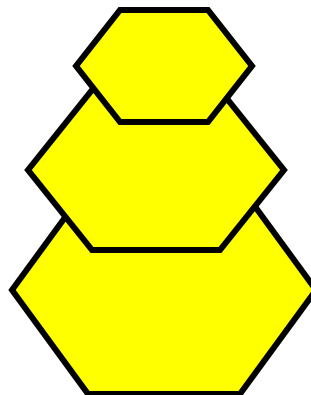
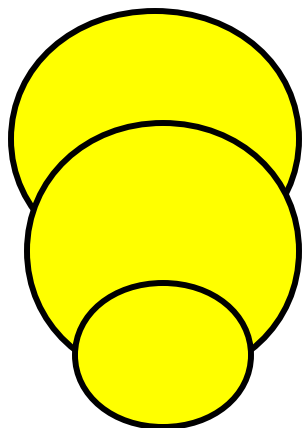

### ASSOCIAZIONI LOGICHE

Far associare le immagine secondo un legame logico.

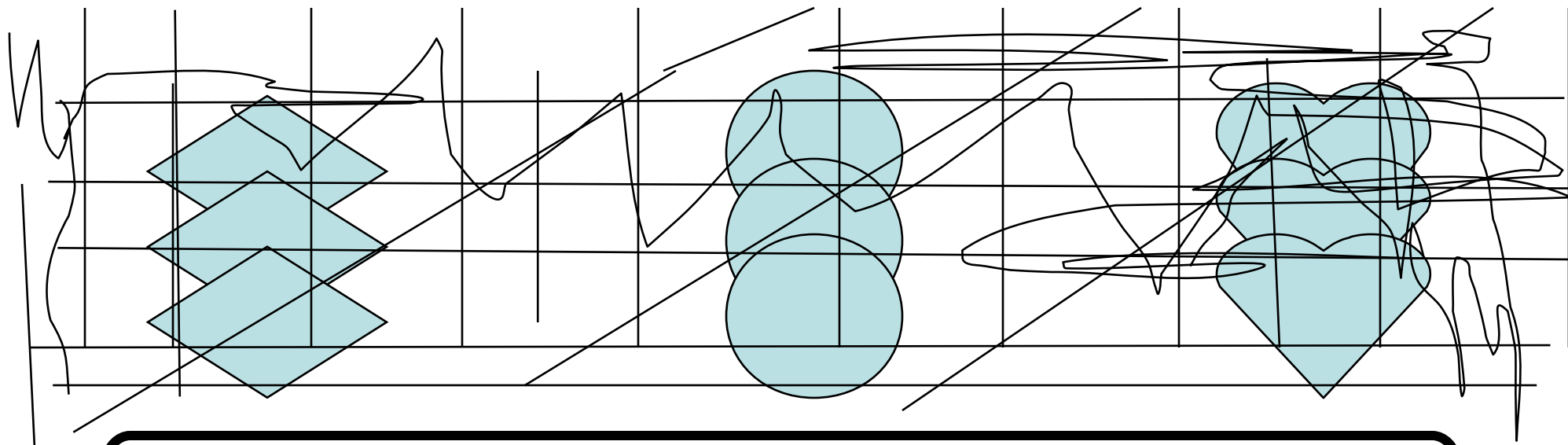
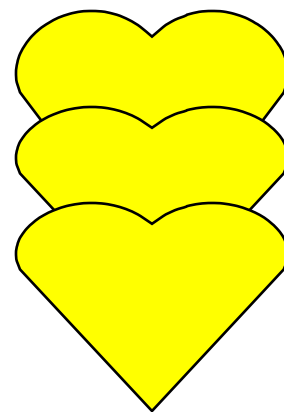
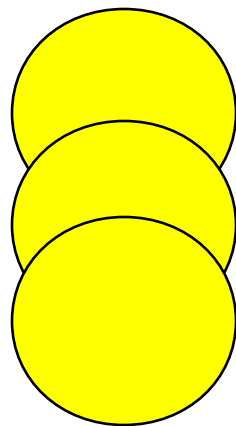
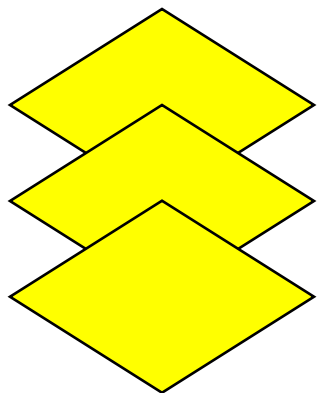

## ASSOCIAZIONI LOGICHE

Far associare le immagine secondo un legame logico.

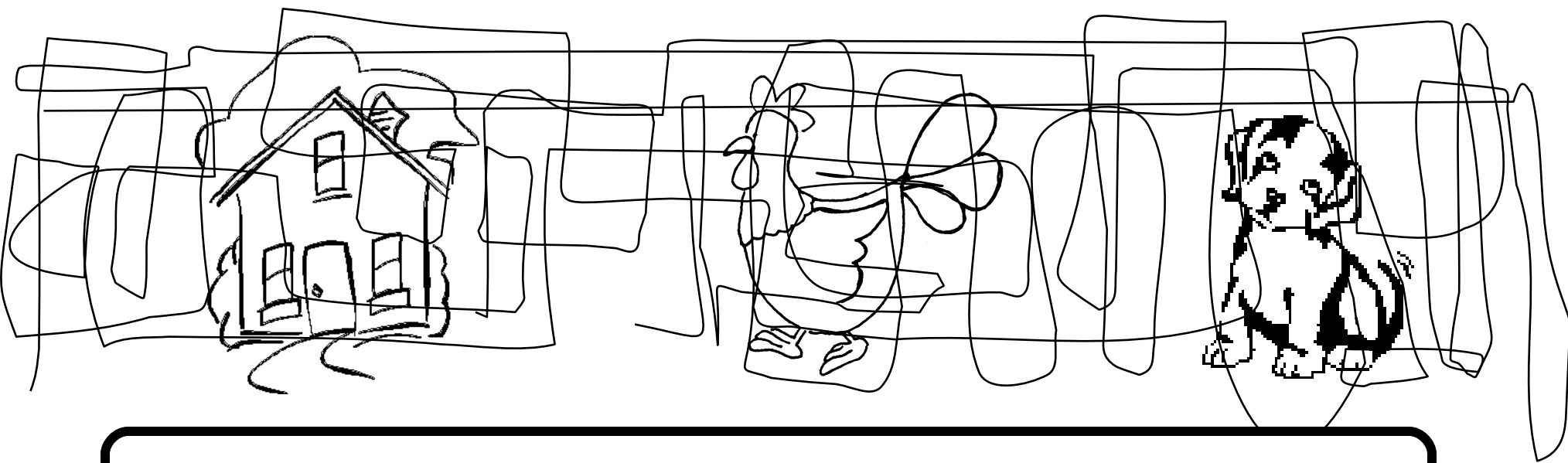
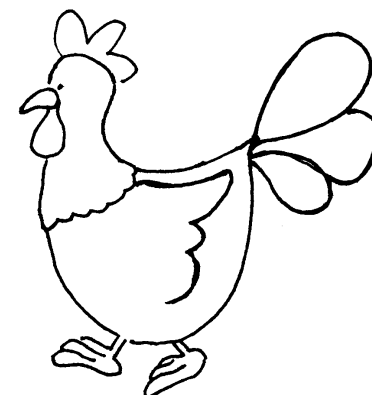

### ASSOCIAZIONI LOGICHE

Far associare le immagine secondo un legame logico.



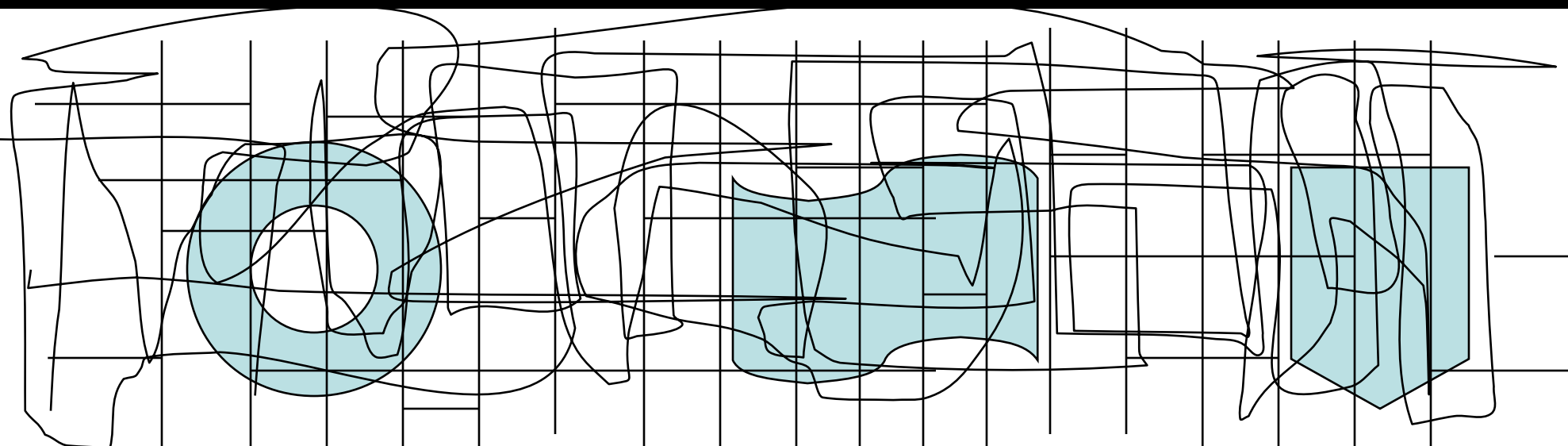
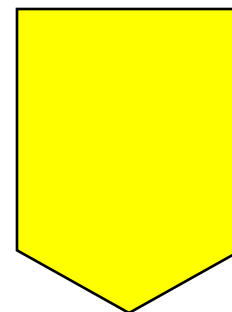
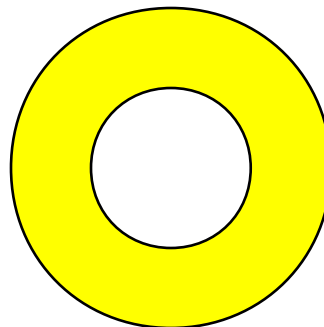
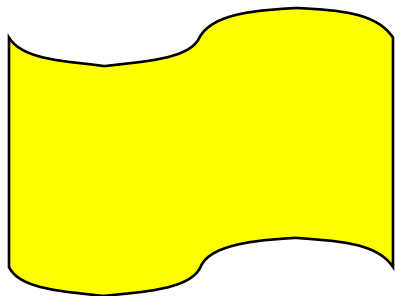

### ASSOCIAZIONI LOGICHE

Far associare le immagine secondo un legame logico.

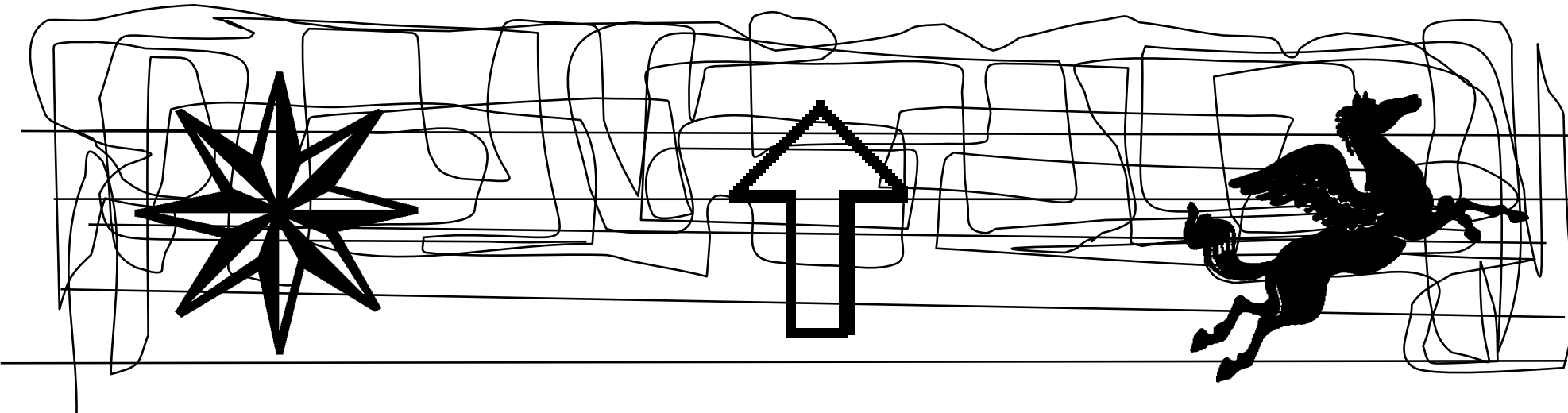
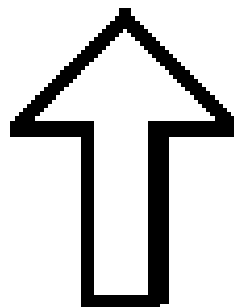
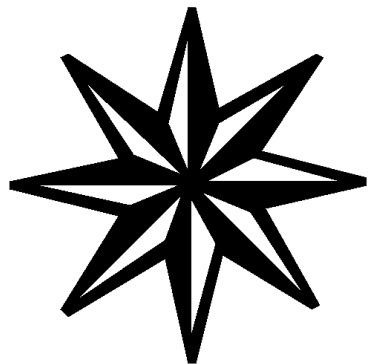

## ASSOCIAZIONI LOGICHE

Far associare le immagine secondo un legame logico.

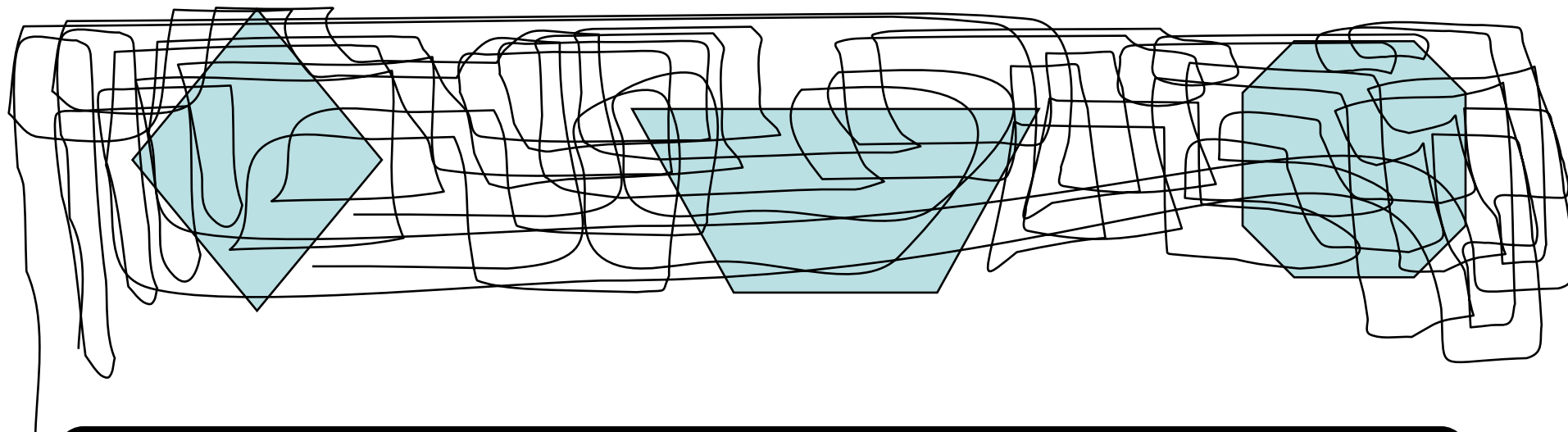
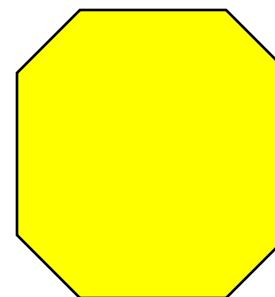
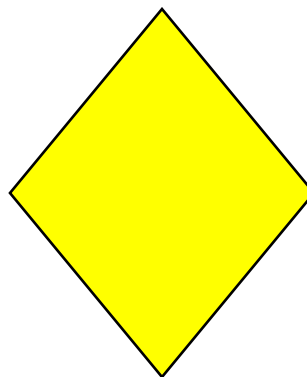
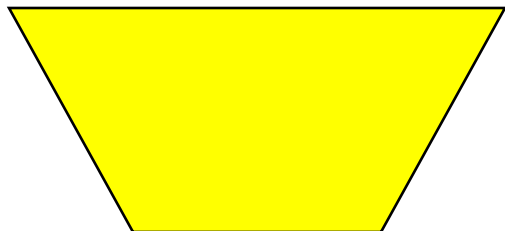

## ASSOCIAZIONI LOGICHE

Far associare le immagine secondo un legame logico.